

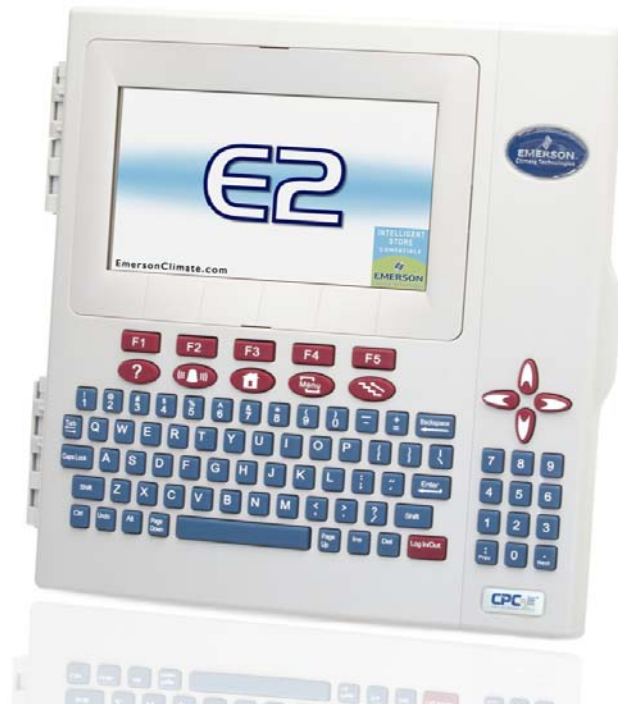

E2 Installation and Operation Manual for RX Refrigeration, BX HVAC, and CX Convenience Store Controllers



Applicable to E2 firmware versions 4.0 and above



Retail Solutions
3240 Town Point Drive NW, Suite 100
Kennesaw, GA 30144, USA

Phone 770-425-2724
Fax 770-425-9319

ALL RIGHTS RESERVED

The information contained in this manual has been carefully checked and is believed to be accurate. However, Computer Process Controls, Inc. assumes no responsibility for any inaccuracies that may be contained herein. In no event will Computer Process Controls, Inc. be liable for any direct, indirect, special, incidental, or consequential damages resulting from any defect or omission in this manual, even if advised of the possibility of such damages. In the interest of continued product development, Computer Process Controls, Inc. reserves the right to make improvements to this manual, and the products described herein, at any time without notice or obligation.

FCC COMPLIANCE NOTICE

This device complies with Part 15 of the FCC Rules. Operation is subject to the following two conditions: (1) this device may not cause harmful interference, and (2) this device must accept any interference received, including interference that may cause undesired operation.

CE COMPLIANCE NOTICE

Class A Product Information for Einstein, E2 Controllers:

The Retail Solutions Einstein and E2 controllers are Class A products. In a domestic environment this product may cause radio interference in which case the user may be required to take adequate measures. This covers:

- All Einstein family product types: RX - Refrigeration Controller (830-xxxx), BX - Building/HVAC Controller (831-xxxx), and all version models: (300, 400, 500).
- All E2 family product types: RX - Refrigeration Controller (834-xxxx), BX - Building/HVAC Controller (835-xxxx), CX- Convenience Store Controller (836-xxxx), and all version models: (300, 400, 500).

TABLE OF CONTENTS

1 INTRODUCTION.....	1-1
1.1 THE E2 REFRIGERATION CONTROLLER (RX).....	1-1
1.2 THE E2 BUILDING CONTROLLER (BX).....	1-2
1.3 THE E2 CONVENIENCE STORE CONTROLLER (CX).....	1-3
1.4 NETWORKING OVERVIEW.....	1-4
1.4.1 E2 I/O Network.....	1-4
1.4.2 The E2 Echelon Lonworks Network.....	1-5
1.4.3 Interconnection With Other E2s.....	1-5
1.5 DOCUMENTATION OVERVIEW.....	1-6
1.6 ON-LINE HELP SYSTEM OVERVIEW.....	1-7
1.7 SOFTWARE LICENSING.....	1-7
2 HARDWARE OVERVIEW.....	2-1
2.1 E2 HARDWARE.....	2-1
2.1.1 E2 Main Processor Board (CPU).....	2-2
2.1.2 E2 Processor Interface Board (PIB).....	2-2
2.1.3 E2 Keypad.....	2-2
2.1.4 LEDs.....	2-2
2.2 I/O NETWORK BOARDS AND PERIPHERALS.....	2-3
2.2.1 The Gateway Board.....	2-3
2.2.2 MultiFlex Boards.....	2-4
2.2.2.1 MultiFlex 16 Input Board.....	2-4
2.2.2.2 MultiFlex Combination Input/Output Boards.....	2-4
2.2.2.3 MultiFlex CUB.....	2-6
2.2.2.4 MultiFlex RTU (BX and CX Only).....	2-6
2.2.2.5 MultiFlex Rooftop Control Board (RCB) (BX and CX Only).....	2-6
2.2.2.6 MultiFlex PAK Board.....	2-6
2.2.3 The MultiFlex ESR Board.....	2-7
2.2.4 Hand-held Terminal (P/N 814-3110).....	2-7
2.2.5 The 8RO and 8ROSMT Relay Boards.....	2-8
2.2.6 4AO Analog Output Board.....	2-9
2.2.7 8DO Digital Output Board and PMAC II Anti-Sweat Controller.....	2-9
2.3 ECHELON NETWORK BOARDS AND PERIPHERALS.....	2-10
2.3.1 The 16A1e (Discontinued).....	2-10
2.3.2 The 8ROe (Discontinued).....	2-10
2.3.3 EC-2s.....	2-11
2.3.4 CC-100 Case Controllers and CS-100 Case Circuit Controllers.....	2-11
2.3.5 TD3 Temperature Display.....	2-11
2.3.6 Facility Status Display (FSD).....	2-12
3 MOUNTING.....	3-1
3.1 MOUNTING THE E2.....	3-1
3.1.1 Standard Mount.....	3-1
3.1.2 Recessed Mount.....	3-1
3.1.3 Retrofit Mounting.....	3-2
3.1.4 Blank Face.....	3-3
3.2 MOUNTING I/O BOARDS.....	3-3
3.2.1 Single/Double Enclosures.....	3-3
3.2.2 Boards Without Enclosures (Snap Track).....	3-4
3.3 ECHELON DEVICES.....	3-5

3.3.1	<i>CC-100 Case Controller and CS-100 Case Circuit Controller</i>	3-5
3.3.2	<i>MultiFlex ESR</i>	3-5
3.3.3	<i>TD3</i>	3-5
3.4	MODEM/COMMUNICATION EXPANSION CARD MOUNTING	3-5
3.4.1	<i>Two-Channel and Four-Channel Repeaters</i>	3-6
3.4.1.1	Mounting Repeaters Overview	3-6
3.4.1.2	Mounting the Two-Channel Repeater	3-6
3.4.1.3	Mounting the Four-Channel Repeater	3-6
3.5	SENSORS AND TRANSDUCERS	3-7
3.5.1	<i>Pressure Transducers</i>	3-7
3.5.1.1	Mounting	3-7
3.5.2	<i>Inside Temperature Sensor</i>	3-7
3.5.2.1	Location	3-7
3.5.2.2	Mounting	3-7
3.5.3	<i>Outside Temperature Sensor</i>	3-7
3.5.3.1	Location	3-7
3.5.3.2	Mounting	3-7
3.5.4	<i>Insertion Temperature Probe</i>	3-8
3.5.4.1	Location	3-8
3.5.4.2	Mounting	3-8
3.5.5	<i>Supply and Return Air Sensors</i>	3-8
3.5.6	<i>Refrigeration System Temperature Probes and Sensors</i>	3-8
3.5.6.1	Location	3-8
3.5.6.2	Mounting Bullet and Pipe Mount Sensors	3-8
3.5.7	<i>Product Temperature Probes</i>	3-8
3.5.8	<i>Humidity Sensors and Humidistats</i>	3-9
3.5.8.1	Indoor RH Sensor	3-9
3.5.8.2	Outdoor RH Sensors	3-9
3.5.8.3	Duct-mounted Insertion RH Probe	3-10
3.5.9	<i>Dewpoint Probe</i>	3-10
3.5.9.1	Location	3-10
3.5.9.2	Mounting	3-10
3.5.10	<i>Light Level Sensor</i>	3-10
3.5.10.1	Location	3-10
3.5.10.2	Mounting	3-10
3.5.11	<i>Liquid Level Sensors</i>	3-11
3.5.12	<i>Refrigerant Leak Detectors</i>	3-11
4	E2 HARDWARE SETUP	4-1
4.1	SETTING UP THE E2	4-1
4.1.1	<i>Enclosure</i>	4-1
4.1.2	<i>Main Processor Board</i>	4-1
4.1.3	<i>Power Interface Board (PIB)</i>	4-2
4.2	POWERING THE E2	4-2
4.2.1	<i>RS485 Ports</i>	4-2
4.2.2	<i>RS485 Termination Jumpers (MODBUS or I/O Net)</i>	4-2
4.2.3	<i>Echelon Network Connect</i>	4-2
4.2.4	<i>Echelon Jumper</i>	4-2
4.3	ADD-ON E2 PERIPHERALS	4-2
4.3.1	<i>Echelon Plug-in Card (P/N 537-4860) with mounting screw (P/N 101-4201)</i>	4-2
4.3.2	<i>COM3 RS232 Plug-In for External Modem</i>	4-3
4.3.3	<i>Internal Modem Plug-in Card</i>	4-3
4.3.4	<i>Plug-In Digital I/O Network Card (P/N 538-4880)</i>	4-3
4.3.4.1	LEDs	4-3
4.3.5	<i>Plug-In Four-Channel Internal Repeater</i>	4-3

5 SERIAL CONFIGURATION.....	5-1
5.1 OVERVIEW	5-1
5.2 COM PORTS	5-1
5.3 SERIAL DEVICE AND SOFTWARE SETUP.....	5-1
6 THE RS485 NETWORK AND HARDWARE SETUP.....	6-1
6.1 THE I/O NETWORK	6-1
6.1.1 I/O Board Names and Terminology.....	6-1
6.1.2 MultiFlex-Plus (+) Board.....	6-2
6.1.2.1 Board Designation	6-2
6.1.2.2 Board Calculations.....	6-2
6.1.3 Wiring Types	6-2
6.1.4 The I/O Network Structure (Daisy Chains).....	6-2
6.1.5 Network Noise Minimization.....	6-2
6.1.6 Network ID Numbers (Board Numbers).....	6-3
6.1.7 Setting the Baud Rate.....	6-3
6.1.8 Setting the Terminating and Biasing Jumpers	6-4
6.1.9 Powering the I/O Boards	6-4
6.1.9.1 Wiring Types	6-5
6.1.10 Board Installation	6-5
6.2 IMC/PRODIGY ROOFTOP UNIT CONTROLLERS.....	6-6
6.3 ECT MODBUS.....	6-6
6.3.1 Control Techniques Drive (VSD).....	6-6
6.3.2 Copeland ISD Compressors.....	6-6
6.3.3 XR, XEV, and XEV22D Case Controllers.....	6-6
6.3.4 iPro DAC.....	6-7
6.3.5 Energy Meter.....	6-7
6.3.5.1 Overview.....	6-7
6.3.5.2 Supported System Types.....	6-7
6.3.6 Modular Refrigerant Leak Detection Sensor (MRLDS)	6-7
6.3.7 Discus	6-8
7 E2 ETHERNET PEER COMMUNICATIONS.....	7-1
7.1 ETHERNET IP CONFIGURATIONS	7-1
7.2 HARDWARE SPECIFICATIONS.....	7-1
7.2.1 Components.....	7-1
7.3 SOFTWARE SPECIFICATIONS	7-2
7.4 ETHERNET NETWORK LAYOUTS.....	7-2
7.4.1 Closed Network Layout.....	7-2
7.4.2 Open Network Layout	7-3
7.5 SOFTWARE SETUP.....	7-3
7.6 TROUBLESHOOTING	7-4
8 ECHELON NETWORK AND HARDWARE SETUP.....	8-1
8.1 OVERVIEW	8-1
8.2 WIRING TYPE.....	8-1
8.3 ECHELON NETWORK STRUCTURING (DAISY-CHAINS).....	8-1
8.3.1 Maximum Number of Echelon Devices.....	8-2
8.4 DEVICE TERMINATION.....	8-2
8.4.1 Using a Termination Block (P/N 535-2715) to Terminate a Daisy Chain	8-3
8.5 WIRE RESTRICTIONS.....	8-3
8.6 INSTALLING ECHELON DEVICES	8-3
8.6.1 Powering Echelon Devices	8-3
8.7 LEDs	8-4

8.8 OPEN ECHELON DEVICE CONNECTIVITY	8-4
8.8.1 <i>Configuring Echelon Devices</i>	8-4
8.8.1.1 Troubleshooting	8-5
9 INPUT AND OUTPUT SETUP	9-1
9.1 THE 16AI, 8IO, AND MULTIFLEX INPUTS	9-1
9.1.1 <i>Connecting Sensors to Input Boards</i>	9-1
9.1.1.1 Wiring	9-1
9.1.1.2 Sensor Wiring Types.....	9-1
9.1.1.3 Input Type Dip Switches	9-1
9.1.2 <i>Power Connection</i>	9-2
9.1.3 <i>Input Setup in E2</i>	9-6
9.1.3.1 Configuring a Point from the Input Definitions/Status Screen.....	9-6
9.1.3.2 Using the Input Definitions/Status Screen.....	9-7
9.1.3.3 Setting Up Analog Inputs.....	9-7
9.1.3.4 Setting Up Digital Inputs	9-9
9.2 THE 8RO, 8IO, AND MULTIFLEX OUTPUTS	9-10
9.2.1 <i>Wiring Form C Contacts</i>	9-10
9.2.2 <i>MultiFlex Relay Outputs</i>	9-10
9.2.3 <i>Setting the Fail-Safe Dip Switch</i>	9-11
9.2.4 <i>Relay Output Test Mode</i>	9-11
9.2.5 <i>Wiring Outputs to Points</i>	9-12
9.2.6 <i>The Output LED</i>	9-12
9.2.7 <i>Output Setup in E2</i>	9-12
9.2.7.1 Configuring a Point from the Output Definitions/Status Screen	9-12
9.2.7.2 Using the Output Definitions/Status Screen	9-13
9.2.7.3 Setting Up Digital Outputs.....	9-13
9.2.7.4 Setting Up Analog Outputs.....	9-14
9.3 CC-100 CASE CONTROLLERS	9-16
9.3.1 <i>Inputs</i>	9-16
9.3.2 <i>Power Module Wiring</i>	9-17
9.3.3 <i>Valve Cable</i>	9-17
9.4 CCB CASE CONTROLLERS.....	9-18
9.5 ESR8 AND MULTIFLEX ESR VALVE OUTPUT WIRING.....	9-18
10 QUICK START	10-1
10.1 LOGGING ON.....	10-1
10.2 CLEANING OUT THE CONTROLLER	10-1
10.3 SETTING NUMBER OF NETWORK DEVICES	10-2
10.4 SETTING NUMBER OF APPLICATIONS	10-3
10.5 THE MAIN STATUS (HOME) SCREEN	10-3
10.5.1 <i>Customizing the Home Screen</i>	10-3
10.6 COMMON SCREEN ELEMENTS.....	10-4
10.6.1 <i>The Header</i>	10-4
10.6.1.1 Header Icons	10-4
10.6.2 <i>The Function Keys</i>	10-4
10.6.3 <i>The Help Line</i>	10-4
10.7 SCREEN TYPES	10-5
10.7.1 <i>The Main Menu</i>	10-5
10.7.2 <i>Status Screens</i>	10-5
10.7.3 <i>The Actions Menu</i>	10-6
10.7.4 <i>The Setup Screens</i>	10-7
10.7.5 <i>System Configuration Menu</i>	10-7
10.7.6 <i>The System Information Menu</i>	10-8
10.8 TIME/DATE SETUP	10-9

10.8.1	Setting the Time and Date	10-9
10.9	SET UP MODEM	10-10
10.10	SET UP TCP/IP	10-11
10.11	SET UP NETWORK BAUD RATES	10-12
10.11.1	COM1 Serial (RS232) Baud Rate	10-12
10.11.2	I/O Network Baud Rate	10-12
10.12	SET UP USER ACCESS	10-13
10.12.1	Changing Required User Access Levels	10-14
10.12.2	Creating a New User Account	10-14
10.12.3	Deleting a User	10-14
10.13	SET UP I/O NETWORK	10-15
10.13.1	Specify Number of Boards	10-15
10.13.2	Checking Online Status	10-15
10.14	SET UP ECHELON NETWORK	10-16
10.14.1	Specifying Number of Devices	10-16
10.14.2	Commissioning a Device	10-16
10.14.2.1	The Service Button Method	10-17
10.14.2.2	The Manual ID Entry Method	10-18
10.15	LICENSE MANAGEMENT	10-19
10.15.1	Web Services	10-20
10.16	SET UP ALARMING	10-20
10.16.1	Specifying Alarm Reporting Types	10-21
10.16.1.1	The Display Line	10-21
10.16.1.2	The Alarm Output	10-21
10.16.1.3	Dial-Out	10-21
10.16.1.4	The Echelon Network (The Alarm Annunciator)	10-21
10.16.2	Setting up an E2 to be an Alarm Annunciator	10-22
10.16.3	Alarm Dial-Out	10-22
10.16.4	Introduction: Alarm Reporting	10-23
10.17	SET UP GLOBAL DATA	10-23
10.17.1	Priority Settings	10-24
10.18	SET UP APPLICATIONS	10-25
10.18.1	Add/Delete an Application	10-25
10.18.2	Using and Configuring a Setup Screen	10-25
10.18.2.1	The Edit Menu	10-26
10.18.2.2	Entering Setpoints	10-26
10.18.2.3	Navigating the Setup Screen	10-26
10.18.3	Using the Help Key to get Property Help	10-28
11	SOFTWARE OVERVIEW	11-1
11.1	SUCTION GROUPS	11-1
11.1.1	Introduction	11-1
11.1.2	The (Standard) Suction Group Application	11-1
11.1.2.1	Overview of PID Control Strategy	11-1
11.1.2.2	Variable-Speed Compressors	11-1
11.1.2.3	Floating Setpoint Control	11-1
11.1.3	The Enhanced Suction Group Application	11-1
11.1.3.1	Learning Mode	11-2
11.1.3.2	Circuit Load Analysis	11-2
11.1.3.3	The Control/Cycles Parameter	11-2
11.1.3.4	Variable-Speed, Digital Scroll, and Digital Discus Compressor Support	11-2
11.1.3.5	Floating Suction Control	11-2
11.1.4	Hardware Overview	11-2
11.2	CONDENSER CONTROL	11-3
11.2.1	Air Cooled Condensers	11-3

11.2.1.1	Air Cooled Strategy	11-3
11.2.1.2	Temperature Differential Strategy	11-3
11.2.2	Evaporative Condensers	11-4
11.2.3	Fan Control	11-4
11.2.4	Condenser Split Mode	11-4
11.2.5	Fast Recovery	11-4
11.2.6	Hardware Overview	11-4
11.3	STANDARD CIRCUITS	11-5
11.3.1	Refrigeration Control	11-5
11.3.1.1	Temperature Monitor	11-6
11.3.1.2	Temperature Control	11-6
11.3.1.3	Line Up(ESR)/Defrost	11-6
11.3.1.4	Line Up(MFESR)/Defrost	11-6
11.3.2	Defrost Control	11-6
11.3.2.1	Defrost States	11-6
11.3.2.2	Defrost Types	11-6
11.3.2.3	Defrost Termination	11-7
11.3.2.4	Emergency Defrost	11-7
11.3.2.5	Hot Gas Defrost with ESR8 and MultiFlex ESR	11-7
11.3.3	Clean and Door Switches	11-7
11.3.3.1	Clean Switches	11-7
11.3.3.2	Door Switches	11-7
11.3.4	Fan Control	11-8
11.3.5	The TD3 Temperature Display	11-8
11.3.6	The Control Link CD Case Display	11-8
11.3.7	Wiring	11-8
11.4	CASE CONTROL CIRCUITS	11-10
11.4.1	Overview	11-10
11.4.2	Case Circuit Control Software Overview	11-10
11.4.2.1	Valve Control	11-11
11.4.3	Refrigeration Control	11-11
11.4.3.1	EEVs (Liquid Pulse and Liquid Stepper)	11-11
11.4.3.2	EEPRs (Suction Stepper)	11-12
11.4.4	Defrost Control	11-12
11.4.4.1	Defrost States	11-12
11.4.4.2	Defrost Types	11-12
11.4.4.3	Defrost Termination	11-13
11.4.4.4	Demand Defrost	11-13
11.4.4.5	Emergency Defrost	11-13
11.4.4.6	The WAIT State	11-13
11.4.5	Anti-Sweat Control	11-13
11.4.5.1	Dewpoint Input Sources	11-14
11.4.6	Dual Temp Control	11-14
11.4.7	Fan Control	11-14
11.4.8	Light Control	11-14
11.4.9	Clean/Wash Mode	11-14
11.4.10	Walk-In Freezer Control	11-15
11.4.11	Fail-Safe Mode	11-15
11.4.11.1	Recoverable Sensor Failures	11-15
11.4.12	Wiring	11-16
11.4.13	Setting Up An Individual Case Controller	11-16
11.4.14	Associating Case Controllers with Case Circuit Control Applications	11-16
11.5	LOGGING GROUPS	11-16
11.5.1	Possible Data Errors	11-17
11.5.2	Data Compression	11-17

11.5.2.1	Clipping.....	11-17
11.5.2.2	Incompressible Data Types.....	11-17
11.5.3	<i>Base Log Group</i>	11-17
11.5.4	<i>Setting Up Logging</i>	11-18
11.5.5	<i>Logging Group Status Screen</i>	11-18
11.5.6	<i>Log Reports</i>	11-19
11.5.6.1	Logging Group Report.....	11-20
11.5.6.2	Application Log Report.....	11-20
11.5.6.3	System Log Report.....	11-20
11.6	AIR HANDLING UNITS (AHU).....	11-21
11.6.1	<i>Overview</i>	11-21
11.6.2	<i>Temperature Control</i>	11-21
11.6.3	<i>Alternate Setpoints</i>	11-21
11.6.4	<i>Fan Control</i>	11-21
11.6.4.1	Single-Speed Fans.....	11-21
11.6.4.2	Two-Speed Fans.....	11-22
11.6.4.3	Variable-Speed Fans.....	11-22
11.6.5	<i>Economizer Control</i>	11-22
11.6.5.1	Economization Enable.....	11-22
11.6.5.2	Economization Lockout Features.....	11-23
11.6.6	<i>Digital Economizer Control</i>	11-23
11.6.7	<i>Analog Economizer Control</i>	11-23
11.6.8	<i>Dehumidification Control</i>	11-23
11.6.9	<i>Curtailement</i>	11-23
11.6.10	<i>Optimum Start/Stop (OSS)</i>	11-23
11.6.11	<i>Separate Setpoints</i>	11-24
11.6.12	<i>AHU Zone Control</i>	11-24
11.6.13	<i>Hardware Overview</i>	11-24
11.7	ZONE CONTROL.....	11-25
11.7.1	<i>Overview</i>	11-25
11.7.2	<i>How Zones Work</i>	11-25
11.7.3	<i>Applications That May Be Connected To Zones</i>	11-26
11.7.3.1	MultiFlex RTU Board.....	11-26
11.7.3.2	MultiFlex RCB Board.....	11-26
11.7.3.3	AHUs.....	11-26
11.7.4	<i>Temperature Control</i>	11-26
11.7.5	<i>Zone Temperature</i>	11-27
11.7.6	<i>Economizer Control</i>	11-27
11.7.7	<i>Economization Enable</i>	11-27
11.7.8	<i>The Effect of Enabling Economization</i>	11-28
11.7.9	<i>Dehumidification Control</i>	11-28
11.7.10	<i>The Zone Humidity Input</i>	11-28
11.7.11	<i>The Effect of Enabling Dehumidification</i>	11-28
11.7.11.1	MultiFlex RTUs and RCBs.....	11-28
11.7.11.2	AHUs.....	11-28
11.7.12	<i>Optimum Start/Stop (OSS)</i>	11-28
11.7.13	<i>Losing Contact With Zone Applications</i>	11-29
11.7.14	<i>Stand-Alone MultiFlex RTUs</i>	11-29
11.7.15	<i>MultiFlex RTU/ARTC and AHU Zone Association</i>	11-29
11.8	MULTIFLEX CUB BOARD.....	11-30
11.9	MULTIFLEX PAK BOARD.....	11-30
11.10	LIGHTING SCHEDULES.....	11-30
11.10.1	<i>Overview</i>	11-30
11.10.2	<i>Functions of the Lighting Schedule Application</i>	11-31
11.10.3	<i>Control Method Select</i>	11-31

11.10.4	<i>Standard Control</i>	11-31
11.10.4.1	The Light Level Interface Cell (LLEV INTERFACE).....	11-31
11.10.4.2	The Schedule Interface Cell (SCHEDIF)	11-32
11.10.5	<i>Alternate Control</i>	11-32
11.10.5.1	Multi-Logic Combiner.....	11-32
11.10.5.2	Offset Solar Control.....	11-33
11.10.6	<i>The Basic Schedule Cell</i>	11-33
11.10.6.1	Slave Scheduling.....	11-33
11.10.7	<i>The Min ON/OFF Cell</i>	11-33
11.10.8	<i>The Proof Cell</i>	11-33
11.10.9	<i>Output Light Dimming</i>	11-34
11.11	DEMAND CONTROL.....	11-34
11.11.1	<i>Introduction to Demand Limit Control</i>	11-34
11.11.2	<i>Demand Monitoring</i>	11-34
11.11.3	<i>Load Shedding</i>	11-35
11.11.3.1	Definition.....	11-35
11.11.4	<i>Shedding Levels</i>	11-35
11.11.5	<i>Priority Levels</i>	11-35
11.11.6	<i>How Demand Control Uses Load Shedding</i>	11-37
11.11.6.1	Power Monitoring Input.....	11-38
11.12	SENSOR CONTROL.....	11-38
11.12.1	<i>Overview</i>	11-38
11.12.2	<i>Analog Sensor Control</i>	11-38
11.12.3	<i>Cut In/Cut Out Setpoint Control</i>	11-38
11.12.4	<i>Digital Sensor Control</i>	11-38
11.12.5	<i>Logical Combination</i>	11-39
11.13	LOOP/SEQUENCE CONTROL	11-39
11.13.1	<i>Layout of the Loop/Sequence Control Application</i>	11-39
11.13.1.1	Control Cells.....	11-39
11.13.1.2	Output Cells.....	11-40
11.13.1.3	Diagram.....	11-40
11.13.2	<i>Loop/Sequence Control Cell Descriptions</i>	11-40
11.13.2.1	The Select Cell.....	11-40
11.13.2.2	The Setpoint Float Cell	11-41
11.13.2.3	The PID Control Cell.....	11-41
11.13.2.4	The Filter Cell.....	11-41
11.13.2.5	The Override Cell	11-41
11.13.3	<i>Output Cell Descriptions</i>	11-41
11.13.3.1	The Sequencer Cell.....	11-41
11.13.3.2	The PWM Cell.....	11-41
11.14	TIME SCHEDULING AND HOLIDAYS.....	11-42
11.14.1	<i>How Schedules Work</i>	11-42
11.14.1.1	Events.....	11-42
11.14.1.2	Absolute and Relative Events	11-42
11.14.1.3	Temporary Schedule Events	11-42
11.14.1.4	Overlapping.....	11-43
11.14.1.5	Ranges.....	11-43
11.14.2	<i>Holiday Schedules</i>	11-43
11.15	POWER MONITORING.....	11-43
11.15.1	<i>Overview</i>	11-43
11.15.2	<i>Logging</i>	11-44
11.15.2.1	Power Monitoring Input.....	11-44
11.16	ANTI-SWEAT SETUP.....	11-45
11.16.1	<i>How Anti-Sweat Works</i>	11-45
11.17	HEAT/COOL CONTROL.....	11-45
11.17.1	<i>Temperature Control</i>	11-45

11.17.2	<i>Unoccupied Hysteresis</i>	11-45
11.17.3	<i>Optimum Start/Stop (OSS)</i>	11-46
11.17.4	<i>Setpoint Reset</i>	11-46
11.17.5	<i>Lead/Lag</i>	11-47
11.18	ANALOG AND DIGITAL COMBINERS.....	11-47
11.19	TD CONTROL.....	11-48
11.19.1	<i>Overview</i>	11-48
11.19.2	<i>Temperature Differential (TD) Strategy</i>	11-48
11.19.3	<i>TD Control Fail-Safes</i>	11-48
11.19.4	<i>Configuration</i>	11-48
11.19.5	<i>Setpoints</i>	11-48
11.19.6	<i>Inputs</i>	11-49
11.19.7	<i>Alarms</i>	11-49
11.20	PULSE ACCUMULATION.....	11-49
11.20.1	<i>Overview</i>	11-49
11.20.2	<i>Configuration</i>	11-49
11.20.3	<i>Outputs</i>	11-49
11.20.4	<i>Accumulator Reset Types</i>	11-50
11.20.5	<i>Logging</i>	11-50
11.20.6	<i>High Trip</i>	11-50
11.21	IRRIGATION CONTROL.....	11-50
11.21.1	<i>Overview</i>	11-50
11.21.2	<i>Zones and Cycles</i>	11-50
11.21.2.1	<i>Cycle Control Types</i>	11-51
11.21.2.2	<i>Timed</i>	11-51
11.21.2.3	<i>Volume</i>	11-51
11.21.3	<i>Cycle Scheduling</i>	11-51
11.21.4	<i>Zone Inhibit</i>	11-51
11.21.4.1	<i>Timed</i>	11-51
11.21.4.2	<i>Volume</i>	11-51
11.21.4.3	<i>Rain Delay</i>	11-51
11.21.4.4	<i>Freeze Lockout</i>	11-51
11.21.4.5	<i>Alarm</i>	11-51
11.21.5	<i>Zone Bypass Inputs</i>	11-51
11.21.5.1	<i>Bypass Failsafe</i>	11-52
11.21.6	<i>Flow Sensor-Related Tests</i>	11-52
11.21.6.1	<i>Leak Test</i>	11-52
11.21.6.2	<i>Obstructed Zone Test</i>	11-52
11.21.7	<i>Service Modes</i>	11-52
11.21.8	<i>Heat Cut In/Cut Out Setpoints For Each Stage</i>	11-52
11.21.9	<i>Cool Cut In/Cut Out Setpoints For Each Stage</i>	11-52
11.21.10	<i>Dehumidification Control</i>	11-52
11.21.11	<i>Two Speed Fan Control</i>	11-52
11.21.12	<i>Configuration</i>	11-53
11.22	FLEXIBLE COMBINER.....	11-53
11.23	MODULAR CHILLER CONTROL (MCC).....	11-53
11.23.1	<i>Overview</i>	11-53
11.23.2	<i>Learning Mode</i>	11-54
11.23.3	<i>The Control/Cycles Parameter</i>	11-54
11.23.4	<i>Compressor Control</i>	11-54
11.23.4.1	<i>Digital Scroll Compressor</i>	11-55
11.23.4.2	<i>Variable Frequency Drive Compressor</i>	11-55
11.23.4.3	<i>Unequal Capacity Compressors</i>	11-55
11.23.5	<i>Bypass Valve Control</i>	11-55
11.24	BOILER.....	11-55

11.24.1	Overview.....	11-55
11.24.2	Alarms	11-55
11.25	REFRIGERANT MONITORING SYSTEM (RMS).....	11-56
11.25.1	RMS Asset.....	11-56
11.25.2	RMS Scale	11-56
11.25.2.1	Device Constraints	11-56
11.26	DETAILED SETPOINT CHANGE LOGGING	11-56
11.26.1	Log Information.....	11-56
11.26.2	Logged Changes.....	11-57
11.26.3	Unlogged Changes	11-57
12	OPERATOR'S GUIDE TO USING THE E2	12-1
12.1	THE E2 HOME SCREEN	12-1
12.1.1	RX Home Screen.....	12-1
12.1.2	BX Home Screen.....	12-1
12.1.3	CX Home Screen	12-2
12.2	LOGGING ON AND ACCESS LEVELS.....	12-2
12.3	TOGGING FULL OPTIONS	12-2
12.4	NAVIGATION	12-3
12.4.1	Menus	12-3
12.4.2	Screen Types.....	12-5
12.4.3	The E2 Keypad	12-6
12.5	CUSTOMIZING THE HOME SCREEN	12-9
12.6	MANUAL DEFROST AND CLEAN MODE	12-9
12.7	OVERRIDES	12-10
12.8	CHECKING BOARDS ONLINE.....	12-11
12.9	CHECKING STATUS SCREENS.....	12-11
12.10	ALARMS.....	12-12
12.10.1	Accessing the Alarm Advisory Log.....	12-12
12.10.2	Viewing the Controller Advisory Log.....	12-12
12.10.3	Date and Time	12-12
12.10.4	State.....	12-12
12.10.5	Ack/Reset State	12-13
12.10.6	Area Ctrl: Application: Property	12-13
12.10.7	Advisory Message.....	12-13
12.10.8	Acknowledging, Resetting, and Clearing Log Entries	12-13
12.10.8.1	Acknowledging	12-13
12.10.8.2	Resetting	12-14
12.10.8.3	Clearing.....	12-14
12.10.9	Facility Status Display (FSD) Alarms.....	12-15
12.11	VIEWING LOGS AND GRAPHS	12-15
12.11.1	Locating Logged Inputs/Outputs.....	12-15
12.11.1.1	Home/Status Screens	12-15
12.11.1.2	Setup Screens	12-16
12.11.1.3	Setting Up Input and Output Pointers.....	12-16
12.11.2	Log View.....	12-16
12.11.3	The Graph View	12-17
12.11.4	Zooming In and Out	12-17
12.12	NAMING CONVENTIONS FOR E2 CONTROLLERS, APPLICATIONS, AND POINTS.....	12-18
	APPENDIX A: CASE TYPE DEFAULTS	A-1
	APPENDIX B: PRESSURE/VOLTAGE AND TEMPERATURE/RESISTANCE CHARTS FOR ECLIPSE TRANSDUCERS & RETAIL SOLUTIONS TEMP SENSORS	B-1
	APPENDIX C: ALARM ADVISORY MESSAGES.....	C-1

APPENDIX D: PID CONTROL..... D-1
APPENDIX E: COMPRESSED POINT LOG SAMPLE LIMITS AND PRECISION TABLE E-1
APPENDIX F: TROUBLESHOOTING F-1
INDEX..... I-1

1 Introduction

The E2 controller is a microprocessor-based control system designed to provide complete control of compressor groups, condensers, refrigerated cases, and other components related to refrigeration and building control. The E2 is the controlling component of a three-network configuration (RS485 I/O, Echelon® Lonworks™ Networks, and Ethernet) that includes input and output communication boards, remote communication software, and a variety of sensors, probes, and transducers.

The E2 efficiently operates all systems that support refrigeration (including compressor racks and condensers) and other components not directly related to refrigeration control, such as HVAC systems, anti-sweat heaters, and sensor control modules.

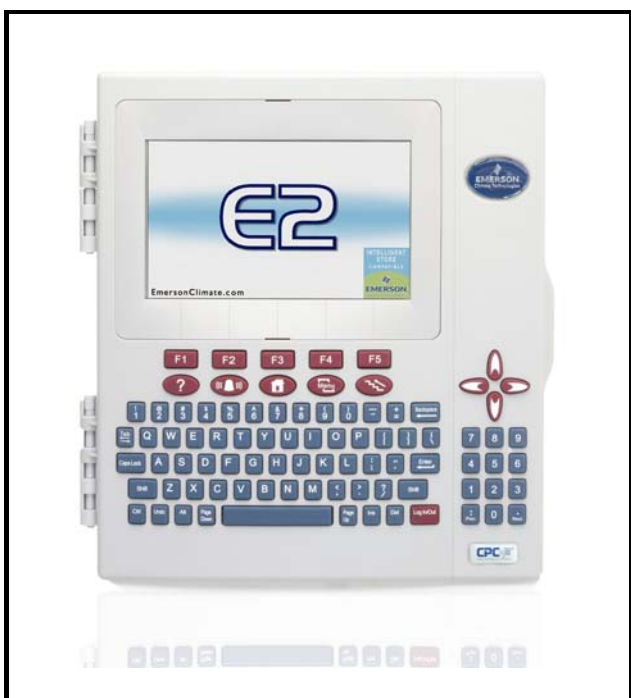

Figure 1-1 - E2 Controller

1.1 The E2 Refrigeration Controller (RX)

The E2 RX is available in three models: the RX-300, RX-400, and RX-100. The E2 RX-300 is capable of controlling a single refrigeration system (including one condenser and up to four suction groups). The E2 RX-400 is capable of controlling two separate refrigeration systems (including two condensers and up to four suction groups). The RX-100 is a low-cost alternative to the RX-300 with

fewer capabilities and a monochrome display.

The E2 RX is primarily designed to control temperature and defrost in refrigerated cases using either direct control (connected to the E2 via I/O boards or ESR8 lineup control boards) or by using CC-100 case control boards (connected via the LonWorks Network).

Table 1-1 shows the differences between capabilities for the RX-300 and RX-400.

Capabilities	RX-100	RX-300	RX-400
Analog Combiner	0	128	128
Analog Import Point	0	64	64
Analog Sensor Control	24	64	72
Anti-Sweat	8	16	64
Case Control Circuit	0	48	64
CC100 Case Suction	0	99	99
CC100 Liquid Control	0	99	99
CCB	0	99	99
Condenser	1	1	2
Control Link ACC	16	63	63
Control Link Case Disp	0	99	99
Control Link RSC	0	99	99
CS100 Ckt Suction	0	99	99
CT Drive	0	16	16
Digital Combiner	0	128	128
Digital Sensor Control	24	64	72
Discus	0	63	63
E2 Alarm Panel	7	7	7
Energy Meter	30	30	30
Enhanced Suction Group	4	4	4

Table 1-1 - RX-100, RX-300, and RX-400 Comparison

Capabilities	RX-100	RX-300	RX-400
ESR8 ESR Control	0	99	99
Flexible Combiner	64	128	128
Heat/Cool Control	0	16	16
Holiday Schedule	4	64	64
Impulse	0	48	64
Infrared Leak Detection	1	16	16
Logging Group	8	32	32
Loop/Sequence Control	4	16	24
Modular Chiller Control	0	1	2
MultiFlex ESR	0	31	31
MRLDS	24	24	24
Performance Alert	0	63	63
Power Monitoring	1	16	16
Pulse Accumulator	0	16	16
RMS Asset	99	99	99
Standard Circuit	48	48	64
Suction Group	4	4	4
TD Condenser Fan Control	4	64	64
TD3 Controller	0	99	99
Time Schedule	4	64	64

Table 1-1 - RX-100, RX-300, and RX-400 Comparison

1.2 The E2 Building Controller (BX)

The counterpart to the E2 RX is the E2 BX, which controls HVAC systems for low-rise retail, industrial, and commercial buildings. The BX's primary function is to provide energy-efficient control of air handling units

(AHUs), rooftop units (RTUs), and other systems related to environment control. In addition, the BX provides extensive sensor control, logging, and graphing features that allow the user to view accurate real-time information about system conditions. The BX is equipped with many power monitoring and demand control features that give you the information you need to keep your site's energy consumption low.

The E2 BX is available in two models: the BX-300 and BX-400. The only significant difference between the E2 BX-300 and the E2 BX-400 is the total number of building control devices that may be operated by a single controller. *Table 1-2* shows the differences between capabilities for the BX-300 and BX-400.

Capabilities	BX-300	BX-400
Advanced Rooftop Control	32	32
AHU	6	8
Analog Combiner	128	128
Analog Import Point	64	64
Analog Sensor Control	64	72
Anti-Sweat	16	48
Control Link ACC	16	48
Control Link Case Disp	99	99
Control Link RSC	99	99
CT Drive	16	16
Demand Control	2	2
Digital Combiner	128	128
Digital Sensor Control	64	72
E2 Alarm Panel	7	7
Energy Meter	30	30
Flexible Combiner	128	128
Heat/Cool Control	16	32
Holiday Schedule	64	64

Table 1-2 - BX-300 vs. BX-400 Comparison

Capabilities	BX-300	BX-400
HVAC Zone	32	40
Infrared Leak Detection	16	16
Lighting Control	24	48
Logging Group	32	32
Loop/Sequence Control	16	28
MRLDS	24	24
Power Monitoring	32	64
Pulse Accumulator	32	64
RCB Controller	64	64
RMS Asset	99	99
TD Condenser Fan Control	16	28
Time Schedule	64	64

Table 1-2 - BX-300 vs. BX-400 Comparison

1.3 The E2 Convenience Store Controller (CX)

The E2 CX controls HVAC, lighting, and refrigeration systems for convenience store and small-box retail facilities. The CX's primary function is to provide energy-efficient control of rooftop units as well as refrigeration and defrost control of display cases and walk-in boxes. In addition, the CX provides extensive sensor control, logging, and graphing features that allow the user to view accurate real-time information about system conditions. The CX is equipped with many power monitoring and demand control features that give you the information you need to keep your site's energy consumption low.

The E2 CX is available in three models: the CX-300, CX-400, and CX-100. The only significant difference between the E2 CX-300 and the E2 CX-400 is the amount of C-Store equipment that may be operated by a single controller. The CX-100 is a low-cost alternative to the CX-300 with fewer capabilities and a monochrome display. *Table 1-3* shows the differences between capabilities for the CX-300 and CX-400.

Capabilities	CX-100	CX-300	CX-400
Advanced Rooftop Control	0	32	32
AHU	4	6	8
Analog Combiner	64	128	128
Analog Sensor Control	12	24	48
Anti-Sweat	4	8	16
Case Control Circuit	0	12	24
CC100 Case Suction	0	99	99
CC100 Liquid Control	0	99	99
CCB	0	99	99
Condenser	0	0	1
Control Link ACC	8	16	16
Control Link Case Disp	6	99	99
Control Link RSC	10	99	99
CS100 Ckt Suction	0	99	99
CT Drive	0	16	16
Demand Control	1	1	1
Digital Combiner	64	128	128
Digital Sensor Control	12	24	48
Discus	0	0	63
E2 Alarm Panel	7	7	7
Energy Meter	30	30	30
Enhanced Suction Group	0	0	4
ESR8 ESR Control	0	99	99
Flexible Combiner	64	128	128

Table 1-3 - CX-100, CX-300, and CX-400 Comparison

Capabilities	CX-100	CX-300	CX-400
Heat/Cool Control	4	6	8
Holiday Schedule	8	16	32
HVAC Zone	4	6	12
Infrared Leak Detection	1	16	16
Irrigation	2	2	2
Lighting Control	6	24	48
Logging Group	8	32	32
Loop/Sequence Control	8	16	28
MultiFlex ESR	0	31	31
MRLDS	24	24	24
Performance Alert	0	0	63
Power Monitoring	2	8	16
Pulse Accumulator	4	8	16
RCB Controller	0	32	32
RMS Asset	99	99	99
Standard Circuit	6	12	32
Suction Group	0	0	4
TD Condenser Fan Control	8	16	28
TD3 Controller	0	99	99
Time Schedule	8	16	32

Table 1-3 - CX-100, CX-300, and CX-400 Comparison

1.4 Networking Overview

1.4.1 E2 I/O Network

Most of the general purpose input and output communications devices required by the E2 to control refrigeration systems are connected to the E2 via the **I/O Network**. The I/O Network is a simple RS485 three-wire connection that allows data interchange between input boards (which read sensor values and digital closures), output boards (which carry out commands from E2's control applications), and the E2 itself.

The I/O Network is the same thing as the COM A and COM D Networks found on Retail Solutions' previous generation of controllers, REFLECS. This allows current owners of Retail Solutions' Refrigeration Monitor and Control (RMC) or Refrigeration Monitor and Case Control (RMCC) controllers to easily retrofit with an E2 RX without need for re-wiring.

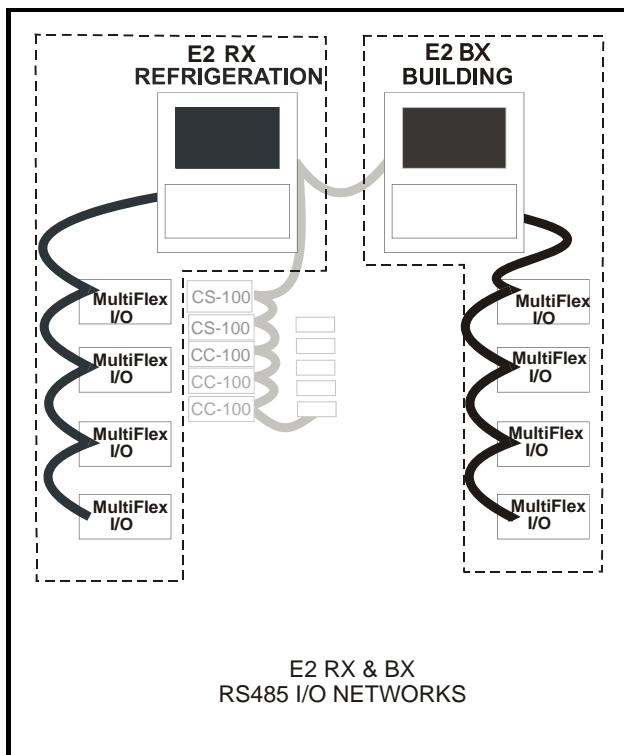

Figure 1-2 - E2 RX/BX I/O Network Diagram

Figure 1-2 shows the peripherals that make up the I/O Network:

- **MultiFlex** - The MultiFlex line of control system boards provide a wide variety of input, output, and smart control solutions, all of which are based on a single universal hardware platform.
- **8ROSMT** - Relay output board - activates and deactivates up to eight devices.

1.4.2 The E2 Echelon Lonworks Network

The E2 is also compatible with a network platform called Lonworks. This is most commonly referred to as “the Echelon Network,” after the company who invented the platform, the Echelon Corporation.

In general, peripherals with control functions — such as case controllers, rooftop HVAC controllers, and other E2 RX and BX units — are interconnected on the Echelon Network. These controllers do most of their own computation and system control, but they communicate with other E2s to provide logging, alarm control, and other functions. In addition to these, Retail Solutions also offers Echelon-compatible input and output boards similar to those available for the RS485 Network.

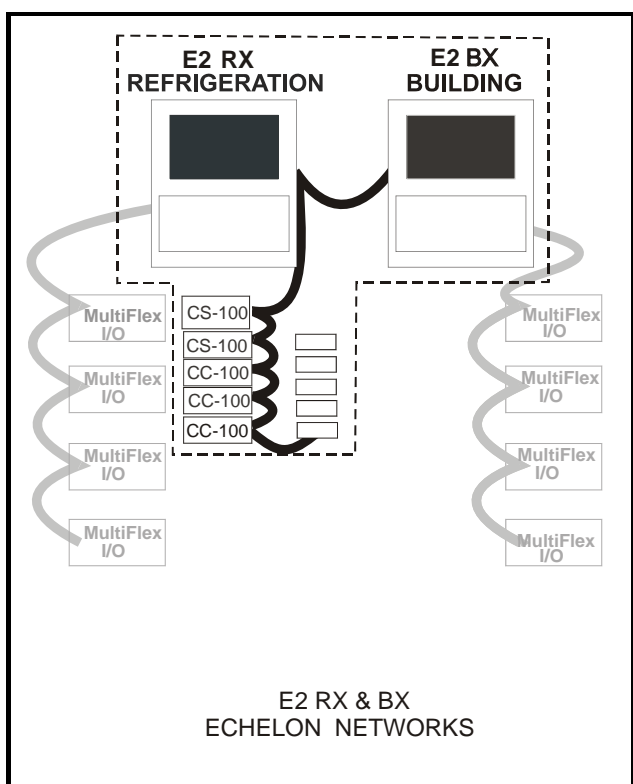

Figure 1-3 - E2 RX Echelon Network Diagram

Figure 1-3 shows the E2 RX peripherals that communicate across the Echelon Network:

- **CC-100** - Case control board - controls all lights, fans, defrost, and refrigeration for a single case. The CC-100 controls pulse or stepper valves to provide precise evaporator control, resulting in better temperature maintenance and energy efficiency.
- **ESR8** - Evaporator stepper regulator - the analog outputs on this board allow the E2 to control circuit temperature in up to eight circuits using suction-

side mounted electronic evaporator pressure regulators (EEPRs).

- **TD3** - Temperature display - has three inputs that monitor case temperature, product temperature and defrost status.
- **Third Party Echelon Devices** - Echelon® LON-MARK® devices communicate with E2 through its “Open Echelon” networking feature, and require a license key and a description file that is loaded into the E2 that enables communication.

1.4.3 Interconnection With Other E2s

In large installations where more than one refrigeration system is present, or where E2s are controlling both refrigeration and building HVAC systems in the same site, the E2s share information with each other across either the Echelon Network or via Ethernet.

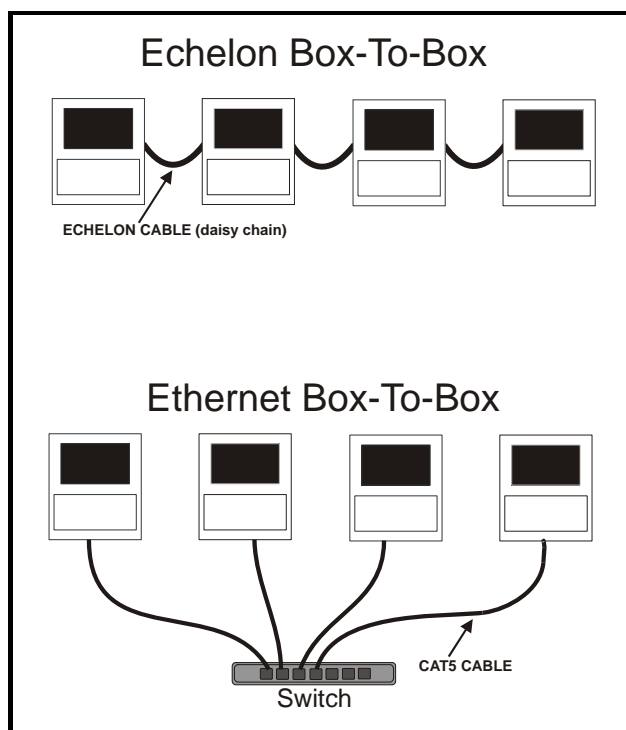

Figure 1-4 - E2 RX/BX Network

1.5 Documentation Overview

The E2 RX and BX controllers are among the most versatile and customizable control system products available on the market. Because of the enhanced capabilities of the E2s, programming, installation, and operation of E2 and its accompanying peripherals are supported by several different Retail Solutions publications. All of the publications listed below can be ordered by contacting Retail Solutions:

- ***E2 Installation and Operation Manual for RX Refrigeration, BX HVAC, and CX Convenience Store Controllers (026-1610)*** - The manual you are currently reading. The Installation and Operation Manual covers hardware installation, network setup, and important operator functions such as viewing status screens or logs, and performing manual defrosts.

The Quick Start section (**Section 10**) is designed to guide you quickly through setup of the most simple and vital refrigeration control applications (such as suction groups and condensers). More detailed information is included in the online help.

- ***Router and Repeater Installation Guide (P/N 026-1605)*** - If you have a large site with 64 or more devices on the Echelon Network, you might require the use of a router or repeater to properly set up your Echelon Network. The Router and Repeater Installation Guide will help you determine when a router or repeater should be used, how and where to set it up, and how to configure the E2(s) on the network to interact with the router or repeater.
- ***Emerson Retail Solutions Product Technical Sheet Binder (P/N 026-1904)*** - The product sheet binder gives important installation information about sensors, transducers, thermostats, and other essential items that are a part of every Retail Solutions control network. The product sheet binder is not necessary for field installation instructions; however, it may be a useful reference for contractors and OEMs who require more information about a specific peripheral.
- ***MultiFlex ESR Installation and Operation Manual (P/N 026-1720)*** - From general information to details on mounting, wiring, and heat dissipation, the MultiFlex ESR manual provides the information you need to install and operate the MultiFlex ESR board, in addition to valuable information on software setup and valve control.
- ***MultiFlex I/O Board Installation and Operation Manual (P/N 026-1704)*** - Installation and operation manual for the MultiFlex 16 and all versions of the MultiFlex combination input/output board, excluding unit controllers such as the CUB and RTU.
- ***MultiFlex CUB/CUB II Condensing Unit Board Installation and Operation Manual (P/N 026-1705)*** - Installation and operation manual for the MultiFlex CUB (old style) and the MultiFlex CUB-II family, which includes the CUB-II and CUB-TD.
- ***MultiFlex RTU Rooftop Controller Installation and Operation Manual (P/N 026-1706)*** - Installation and operation guide for the MultiFlex RTU (replacement for ARTC).
- ***MultiFlex RCB Rooftop Controller Installation and Operation Manual (P/N 026-1707)*** - An improved version of the MultiFlex RTU, the RCB has 16 fully configurable analog and digital input points. The RCB also has four analog outputs for use in controlling variable speed fans, economizers, or modulating heating and/or cooling valves. The RCB also features a more sophisticated HHT interface and updated algorithms for controlling heating, cooling, dehumidification, and air quality. Refer to this manual for more information on the MultiFlex RCB Rooftop Controller.
- ***E2 User's Manual Supplement for Flexible Combiner Programming (P/N 026-1620)*** - The Flexible Combiner application is an advanced I/O control program used to combine multiple analog and digital input values using programmed equations similar to those used in spreadsheets, and is a new feature of E2 versions 2.20 and above. Refer to this manual for more information on the Flexible Combiner application.
- ***Facility Status Display (FSD) Installation and Operation Manual (P/N 026-1400)*** - The FSD reports alarm information and more, (such as temperatures, occupancy, case status, and setpoints) and provides a centralized device for store personnel to review information by communicating with the E2 via Ethernet connectivity (minimum E2 firmware rev. 2.68F01). Refer to this manual for more information on the Status Display application.
- ***Square D Smart Breaker Control Manual (P/N 026-1711)*** - The Smart Breaker products are designed to allow the Retail Solutions family of site controllers to command control panels (minimum E2 firmware rev. 2.71F01). A breaker panel generally consists of a series of circuit breakers that are

flipped from OFF to ON and from ON to OFF by commands sent from E2 through MODBUS or a Square D Smart Breaker Gateway board. Refer to this manual for more information on the Square D Breaker Panel application.

- **Eaton Breaker Control Manual (P/N 026-1709)** - E2 can communicate directly with Eaton's Breaker Control Bus (BCB) modules. Communication with the E2 (minimum E2 firmware rev. 2.82) will enable users to access features such as Time Schedules, Enhanced Lighting, and Logging, with the added capabilities of dial-out on failure and offsite remote connection, specifically with UltraSite32 and Site Manager to the breaker panel. The Eaton Breaker Panel controller is a licensed application available in the E2 300 and 400 model controllers. Refer to this manual for more information on the Square D Breaker Panel application.
- **Energy Meter Manual (P/N 026-1726)** - The Energy Meter provides a solution for measuring energy data with a single device. Inputs include Control Power, CT, and 3-phase voltage. The Energy Meter supports multiple output options, including solid state relay contacts, Modbus (with or without data logging), and pulse. The LCD screen on the faceplate allows instant output viewing.
- **iPro DAC (P/N 026-1727)** - The iPro DAC is a packaged HVAC control board for use either as a stand-alone controller or in zone control applications using a Retail Solutions E2 BX building control system. The iPro DAC is capable of controlling heat and cool stages, fans, humidification and dehumidification devices and economizers using on-board I/O and control algorithms, as well as monitor and interact with other building control systems and peripherals (such as smoke alarms and CO2 sensors).
- **MRLDS (P/N 026-1307)** - Modular Refrigerant Leak Detection Sensor (MRLDS) continuously monitors for low levels of refrigerants most commonly used in commercial refrigeration systems. The MRLDS communicates with the E2 controller via MODBUS. The E2 provides an interface while the MRLDS will provide the leak monitoring functionality.

1.6 On-Line Help System Overview

The E2 On-Line Help is the primary source front-panel/interface users will have to consult when seeking instruction on properties, screens, menus, and troubleshooting of hardware/software problems. The on-line help topics are designed to minimize the time the user would otherwise have to spend searching through the manual to find information. Press **Shift** + **?** keys to open the General Help menu.

To use on-line help from any screen in the E2 front panel interface, simply press the E2's permanent Help **?** key. This opens a pop-up window containing either information about the screen or menu you are currently on, or information about the input, output, or setpoint you have highlighted with the cursor (if available). After the Help **?** key has been pressed, **F1** will open the General Help menu containing Troubleshooting options.

1.7 Software Licensing

Some applications in the E2 are available only when activated with a unique license key that is obtained through Retail Solutions. Software licensing (see **Section 10.15, License Management**) allows the user to activate certain features in the E2, such as Web Services and third-party controllers. Call your Retail Solutions sales representative at 770-425-2724 for more information about software licensing.

2 Hardware Overview

This section gives an overview of the E2, the hardware, and how it communicates across the I/O and Echelon Networks to control an entire system.

2.1 E2 Hardware

The E2 controller is programmed to monitor and command all aspects of a refrigeration or building environmental control system. The E2 uses both an RS485 I/O Network and a LonWorks Network to gather data from input devices, communicate with other E2s, and activate or deactivate loads.

In general, an E2 control network will consist of the following components:

1. *E2* - The “brain” of the control network, which performs all necessary computations and sends commands to the output devices that control the system.
2. *Input Boards* - Transfer readings to the E2.
3. *Output Boards* - Banks of relays, digital pulse outputs, or analog outputs, which the E2 may use to control loads.
4. *Smart Boards* - Boards such as case controllers (for refrigeration) or rooftop controllers (for building control) that perform control functions for an individual case or rooftop unit, and send the data to the E2 for logging and alarm purposes.
5. *Modem* - For remote communication via phone, if necessary.
6. *Network Wiring* - Wiring that connects the E2 to other E2s, and all the input, output, and smart boards.
7. *Sensors and Loads* - The “eyes” and “hands” of the control network. *Sensors* “see” what needs to be controlled on the network, and *Loads* are what can be controlled, or more specifically, be turned on and off, such as compressors, condensers, lights, and fans.

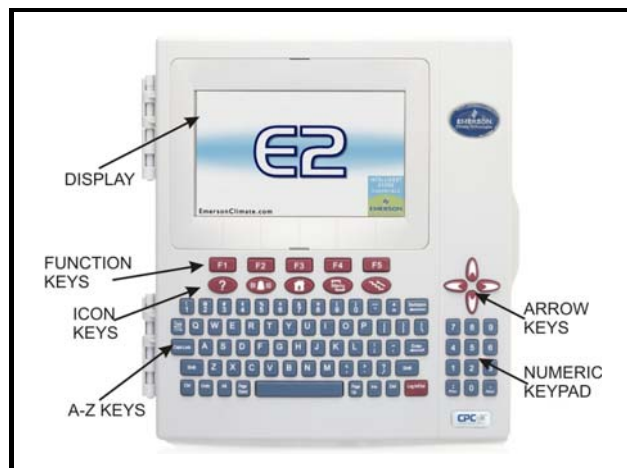

Figure 2-1 - E2 Front Panel

Dimensions	Standard Mount: 9.06" W x 12.06" H x 3.75" D
	Recessed Mount: 9.06" W x 10.56" H x 2.0" D
	Base: 10.56" W x 10.56" H x 3.75" D
Operating Temp	-40°F to 149°F (-40°C to 65°C)
Storage Temp	-40°F to 158°F (-40°C to 70°C)
Operating Humidity	5% - 95% RH non-condensing at 90°F
Storage Humidity	5% - 100% RH
Power	24 VAC ±20%, 50/60 Hz, Class 2
VA Load	50

Table 2-1 - E2 Specifications



NOTE: Contact Retail Solutions Customer Service at 770-425-2724 for E2 controller part numbers and model descriptions.

2.1.1 E2 Main Processor Board (CPU)



Figure 2-2 - E2 CPU

The E2 CPU or main processor board (**Figure 2-2**) contains the CPU, Ethernet port, and memory used for logging. The 3.6V battery for the E2 is located on this board and protects log and alarm data during power loss. The main processor board connects to the PIB via a ribbon cable. The RX- and CX-100 versions support monochrome display only. For optimum viewing, backlight and contrast adjusts are available for customizing the monochrome display depending on the user's needs.

2.1.2 E2 Processor Interface Board (PIB)

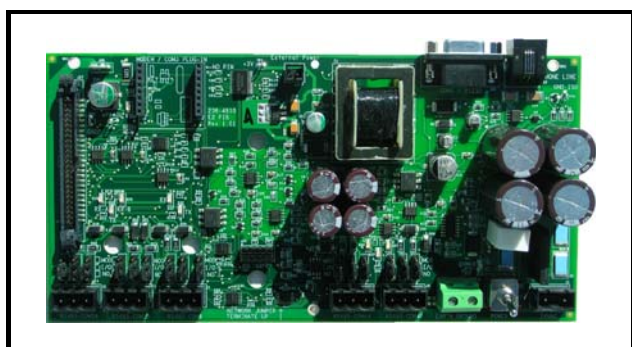







Figure 2-3 - E2 PIB

The E2 Processor Interface Board (PIB) interfaces the power and most all communications with the main processor board, and contains all field wiring connections. The PIB allows you to connect an external keyboard, accessory cards, and an external computer. All RS485 connectors are located on the PIB.

2.1.3 E2 Keypad



Figure 2-4 - E2 Keyboard

The E2 has a QWERTY style keyboard layout with two rows of function keys. The first row (**F1 - F5**) is comprised of screen-specific function keys, and the second row has designated icon keys. The five icon keys are Help , Alarms , Home , Menu , and Back .

2.1.4 LEDs

The PIB, main processor board, and keyboard (located behind the main board) LEDs can be used to determine the status of normal operating parameters for the unit.

PIB LEDs	Status
Green (14)	ON: Power is being applied to the PIB
Yellow (RX1)	ON: Communication is being received on RS485 Port 1A
Yellow (RX2)	ON: Communication is being received on RS485 Port 1B
Red (TX)	ON: Communication is being sent on RS485 Port 1A and 1B

Table 2-2 - PIB LED's Status

Main Board (CPU) LEDs	Status
Green (D1 General Status LED for E2 and Blank Face E2)	1 blink every two seconds (1 second ON, 1 second OFF): Main board is operating normally. Solid ON: E2 is booting up. Faster blinks per second: Indicates an error condition with the hardware or firmware.
Green (D18 Boot Status LED)	ON: E2 is booting up.

Table 2-3 - Main Board (CPU) LED's Status

Keyboard LED	Status
Green (D5 General Status LED)	1 blink every two seconds (1 second ON, 1 second OFF): Status is normal. 4 blinks per second: A flash and/or crystal problem has been detected. Board should be replaced.

Table 2-4 - Keyboard LED's Status

2.2 I/O Network Boards and Peripherals

2.2.1 The Gateway Board

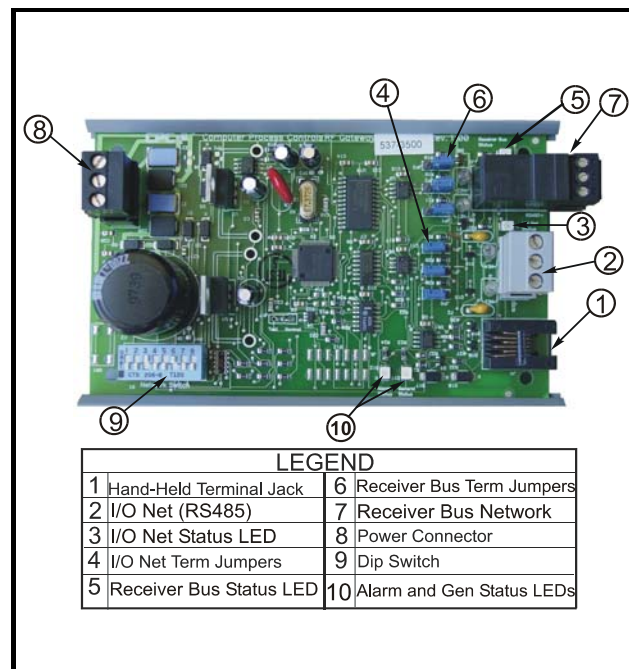

Figure 2-5 - Gateway Board

The Gateway board is an RS485 to RS485 converter. One side of the Gateway is always connected to the Retail Solutions I/O Network. The other side of the Gateway is the receiver bus (RS485). The receiver bus is connected to one or more RS485 devices depending on which type of Gateway is being used. The Gateway interfaces devices to the Einstein/E2 and legacy Retail Solutions controller (REFLECS) by simulating 16AI and 8RO boards using Retail Solutions standard I/O board protocol. The Gateway can also convert third-party controller protocols to Retail Solutions protocol for custom cells created in the Einstein/E2 to interface with third-party controllers (Danfoss, Woodley, etc.).

The Gateway performs one of two basic functions:

1. It allows control of and/or status of a device using I/O board simulation
2. Converts a third-party protocol to Retail Solutions I/O Net protocol and interfaces to a custom

cell in Einstein/E2

P/N	Gateway Model
810-3500	RF Gateway
810-3700	IRLDS II Gateway
810-3760	RLDS Gateway
810-3710	Danfoss MicroCool Gateway
810-3711	Woodley Case Controller Gateway
810-3712	Woodley Pack Controller Gateway
810-3720	Cutler Hammer Breaker Gateway
810-3721	Square D Breaker Gateway

Table 2-5 - Gateway Board Models

2.2.2 MultiFlex Boards

The MultiFlex line of control system boards provides a wide variety of input, output, and smart control solutions, all of which are based on a single universal hardware platform. The board design uses flash-uploadable firmware and plug-in expansion boards to configure the base platform board and apply it for use as an input board, relay output board, analog output board, or a combination I/O board.

2.2.2.1 MultiFlex 16 Input Board

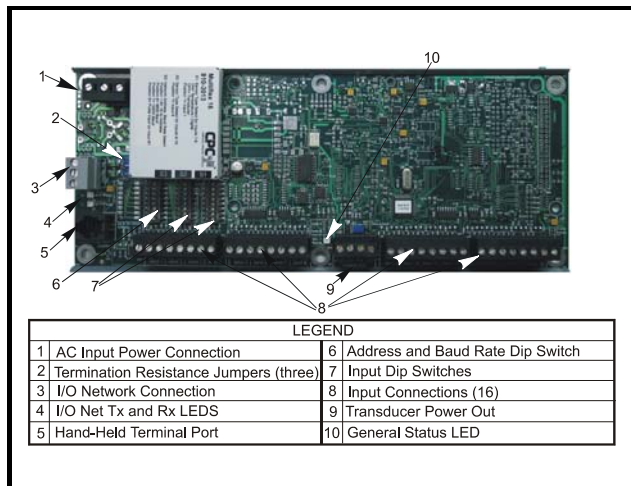

Figure 2-6 - MultiFlex 16 Input Board

The MultiFlex 16 input board offers sixteen combination analog/digital input points for use by Retail Solutions E2, Einstein, and REFLECS control systems. The MultiFlex 16 may be used in retrofits with no additional hardware or software setup or upgrades.

The MultiFlex 16 is designed to be 100% compatible with the previous generation of Retail Solutions input boards (the 16AI), communicates with the site controller via an RS485 connection to a REFLECS COM A&D Network or an E2 I/O Network. Dip switches on the board set the network ID (board number) and baud rate.

The board also provides both +5VDC and +12VDC output voltage points for use in powering transducers or other input devices that require power.

The MultiFlex 16 has a Hand-held Terminal interface **Section 2.2.4, Hand-held Terminal (P/N 814-3110)** that may be used by technicians to view the input voltage and engineering unit values for each input point without need of a voltmeter or front panel controller display.

Table 2-6 shows the part number of the MultiFlex 16.

P/N	Model Name	Description
810-3013	MultiFlex 16	16 analog/digital inputs, no outputs

Table 2-6 - MultiFlex 16 Input Board Model

The MultiFlex 16 is designed with several features that make it easy to install, wire, and configure. These main user interface features are shown in **Figure 2-6**.

2.2.2.2 MultiFlex Combination Input/Output Boards

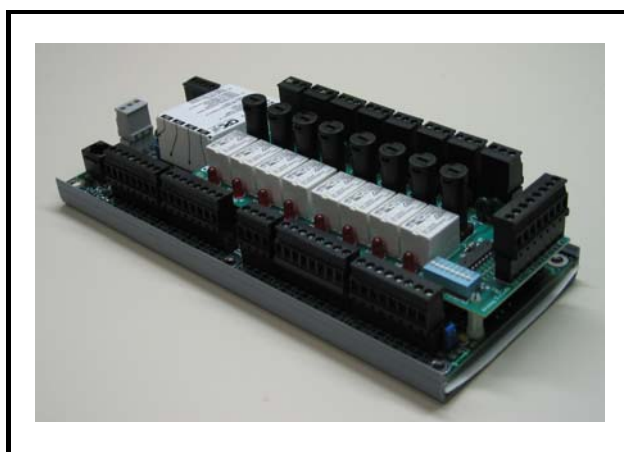

Figure 2-7 - MultiFlex Combination Input/Output Board (Side View)

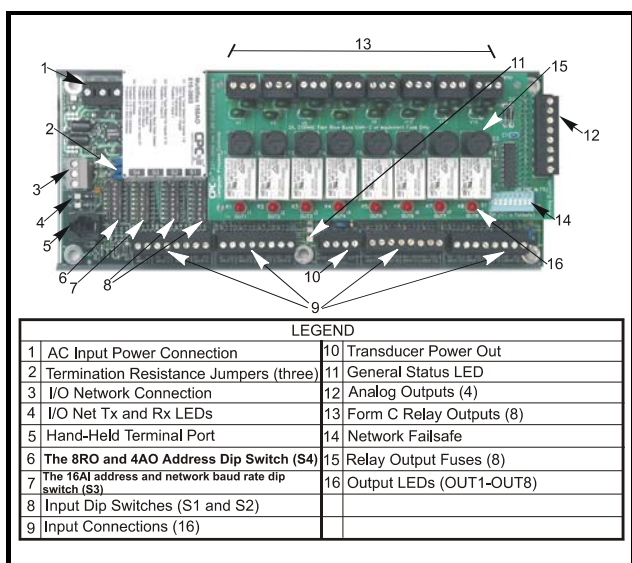

Figure 2-8 - MultiFlex Combination Input/Output Board (Top View)

There are several models of the MultiFlex board that combine the functionalities of input boards, relay output boards, digital output boards, and analog output boards. The MultiFlex combination input/output boards are designed to be replacements for the 8IO Combination Input/Output Board, but the MultiFlex board provides several new hardware options and software features.

The MultiFlex combination I/O boards consist of up to 16 combination digital/analog inputs, and a combination of relay outputs, digital outputs, and analog outputs.

All boards feature both +5VDC and +12VDC output voltage points for use in powering transducers or other input devices that require power.

On the RS485 Network, the MultiFlex combination input/output boards present themselves to Einstein, E2, or REFLECS site controllers as 16AI Analog Input Boards, 8RO Relay Output Boards, 8DO Digital Output Boards, and/or 4AO Analog Output Boards, depending on what type of inputs or outputs are equipped. Dip switches are used to assign network ID numbers to each board type.

The MultiFlex combination input/output boards also support a Hand-held Terminal interface, **Section 2.2.4, Hand-held Terminal (P/N 814-3110)** which allows technicians to view input values, check relay and analog output states, and override output points with fixed digital or analog values. For more information on MultiFlex I/O boards, refer to the *MultiFlex I/O Board Installation and Operation Manual (P/N 026-1704)*.

Table 2-7 shows the available models of MultiFlex combination input/output boards with description and part numbers.

P/N	Model Name	Description
810-3063	MultiFlex 88AO	8 analog/digital inputs, 8 relay outputs, 4 analog outputs
810-3064	MultiFlex 88	8 analog/digital inputs, 8 relay outputs
810-3065	MultiFlex 168AO	16 analog/digital inputs, 8 relay outputs, 4 analog outputs
810-3066	MultiFlex 168	16 analog/digital inputs, 8 relay outputs.
810-3067	MultiFlex 168DO	16 analog/digital inputs, 8 relay outputs, 4 digital outputs
810-3072	MultiFlex 1616L	16 analog/digital inputs, 16 low-voltage (24VAC rated) relay outputs
810-3073	MultiFlex 1616LAO	16 analog/digital inputs, 16 low-voltage (24VAC rated) relay outputs, and 4 analog outputs.
810-3077	MultiFlex 1616LDO	16 analog/digital inputs, 16 low-voltage (24VAC rated) relay outputs, and 4 pulse-width modulating digital outputs

Table 2-7 - MultiFlex Combination Input/Output Board Models

2.2.2.3 MultiFlex CUB

The MultiFlex Condensing Unit Board (CUB) is a “smart” input/output board designed to control single condensing units. A single condensing unit is a self-contained compressor and condenser bearing unit which controls refrigeration in a single case line-up or walk-in cooler.

The MultiFlex CUB uses the same general hardware configuration as a MultiFlex 168AO. It is equipped with a processor and extra memory to allow it to control compressors, condensers, refrigeration, and defrost for a single condensing unit using on-board I/O and control algorithms.

The MultiFlex CUB has its own installation and operation manual, (P/N 026-1705).

2.2.2.4 MultiFlex RTU (BX and CX Only)

Similar in design to the MultiFlex combination input/output boards, the MultiFlex RTU board is designed specifically for operating package rooftop HVAC units as part of an E2 BX or REFLECS BCU building control system. The MultiFlex RTU is designed to be a replacement for the previous generation ARTC, and is 100% compatible with all legacy E2 BX and BCU systems.

The MultiFlex RTU board has 16 analog inputs, 8 relay outputs and 4 analog outputs. Most of these I/O points are reserved for sensors and input devices required to read environmental data (such as space and supply air temperature) and control all output devices that control the environment (such as heat/cool stages and dampers). The RTU relay outputs are rated for line voltage (240VAC).

The RTU board controls the rooftop unit directly with its built-in heating, cooling, and humidity control algorithms. It may operate in stand-alone mode, or it may interface with an E2 BX or BCU to control the store environment in zones and pass along logging and alarm information.

The MultiFlex RTU has its own installation and operation manual, (P/N 026-1706).

2.2.2.5 MultiFlex Rooftop Control Board (RCB) (BX and CX Only)

The MultiFlex Rooftop Control Board (RCB) (P/N 810-3062) is a rooftop HVAC control board for use either as a stand-alone controller or in zone control applications using a Retail Solutions E2 BX building control system. The MultiFlex RCB is capable of controlling heat and cool stages, fans, humidification and dehumidification devices, economizers using on-board I/O and control algorithms, as well as monitor and interact with other building control systems and peripherals (such as smoke alarms and CO₂ sensors).

The RCB is an improved version of the MultiFlex RTU. The RCB has sixteen fully configurable analog and digital input points, whereas the RTU has only eight inputs, two of which are configurable. The RCB has four analog outputs for use in controlling variable speed fans, economizers or modulating heating and/or cooling valves, whereas the RTU has only two analog outputs for use only with VS fans and economizers. The RCB also features a more sophisticated HHT interface and updated algorithms for controlling heating, cooling, dehumidification, and air quality.

The MultiFlex RCB has its own installation and operation manual, (P/N 026-1707).

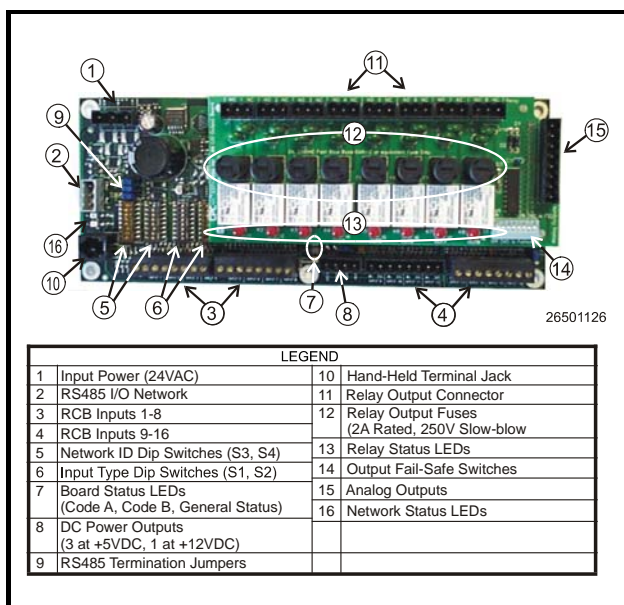

Figure 2-9 - MultiFlex RCB

2.2.2.6 MultiFlex PAK Board

The PAK is a distributed pack (rack) controller that controls compressors and condenser fans. The PAK can control up to 8 compressor groups containing up to 16 compressors. The compressor control strategy is Fixed Steps with setpoint/deadband using ON and OFF delays. Up to 20 Fixed Steps can be configured.

The PAK can control up to 4 condenser fan groups containing up to 8 total condenser fans. The PAK condenser control strategy is sequential TD control with setpoint/deadband using ON and OFF delays.

The PAK has a compressor/condenser interlock feature that will override TD control and force the condenser fans to stage off using the TD control OFF delay when all compressors are off. This feature can be disabled with an Enable/Disable setpoint or when the discharge pressure is above a configurable setpoint.

The MultiFlex PAK boards consist of two circuit boards: a bottom layer with 16 combination digital/analog inputs, and a plug-in top layer which contains a combination of 8 relay outputs and 4 digital DC voltage outputs.

The analog outputs on the Multiflex PAK drive solid state relays to control the fan stages. The relays control the compressor groups.

The communication interface is RS485 I/O using the Standard Extended Address Form for Retail Solutions Distributed Controllers. Currently, the PAK is designed to interface with the Retail Solutions E2 controller.

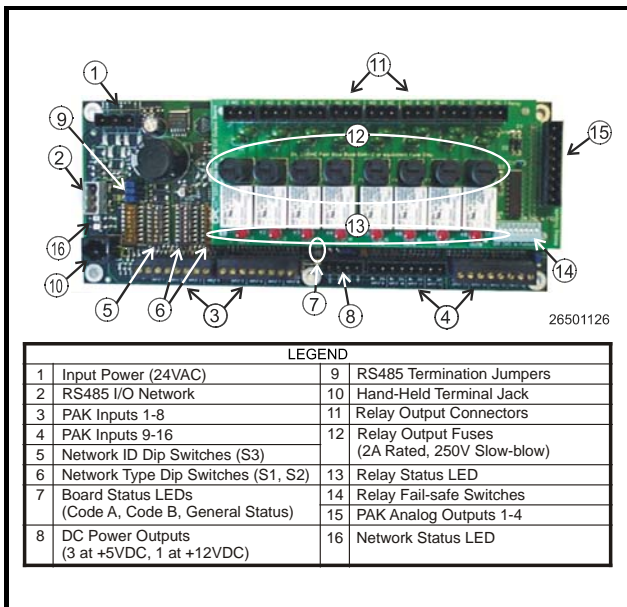

Figure 2-10 - MultiFlex PAK

2.2.3 The MultiFlex ESR Board

The MultiFlex ESR Valve Regulator board (P/N 810-3199), shown in Figure 2-11, is an RS485 I/O Network electronic stepper valve regulator capable of driving up to eight stepper motor valves, which are typically used to control temperature.

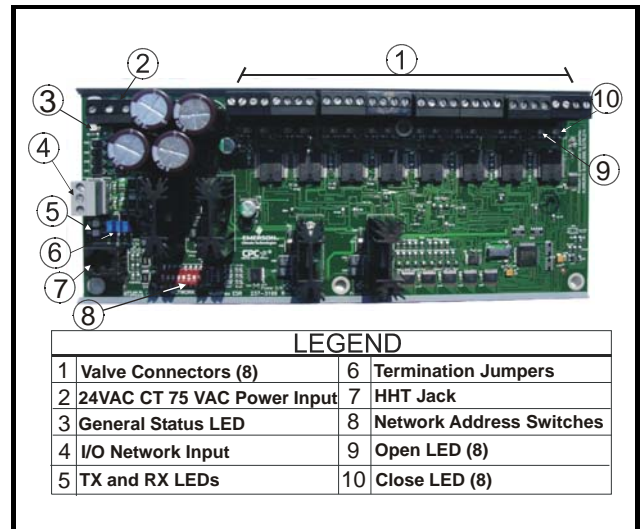

Figure 2-11 - MultiFlex ESR Board Layout

The MultiFlex ESR uses suction side variable-position evaporator regulators (ESRs) to vary evaporator pressure for an entire circuit and is an alternative to mechanical EPR control.

The MultiFlex ESR receives input data from a Retail Solutions E2 controller (via the I/O Network) and then regulates the stepper valves according to the data from the E2.

Each MultiFlex ESR board requires a Class 2, 80VA 24VAC center-tapped transformer for power. Retail Solutions transformer (P/N 640-0080) is a multi-tapped primary transformer that may be used with the MultiFlex ESR board.

2.2.4 Hand-held Terminal (P/N 814-3110)

The Hand-held Terminal (HHT) is used by manufacturers and service technicians to diagnose and test several of Retail Solutions' existing and legacy products. The HHT can be used on any Retail Solutions product with an RJ-11 connector. The most common applications include:

- All MultiFlex I/O boards and the 8ROSMT
- All Gateway boards
- Stand-alone MultiFlex boards (RTU, RCB, PAK, CUB)
- CCB and CC-100 case controllers

The HHT does not require a separate power source. The unit is powered from the RJ-11 connector on the peripheral equipment. The HHT includes a standard male RJ-11 to male RJ-11 cable.

NOTE: The 9V battery and 9-12VDC adapter connection are not used on this HHT model (P/N 814-3110).

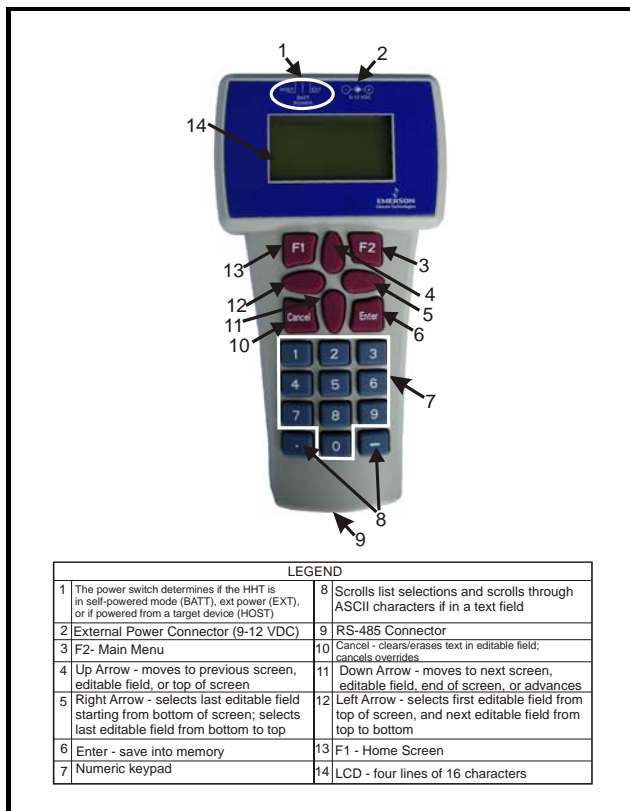

Figure 2-12 - Hand-held Terminal (814-3110)

2.2.5 The 8RO and 8ROSMT Relay Boards

The 8RO (P/N 810-3005) board is a general-purpose board used to connect an E2 to any of eight standard control relay outputs, but is now obsolete and has been replaced by the 8ROSMT (P/N 810-3006) board.

To function, the 8RO board must be connected through either the Echelon Network or the RS485 I/O Network to the E2. When properly installed, the 8RO receives an electrical impulse from the E2, which either opens or closes any of eight contact relays. Output definitions within the E2 allow the user to configure the 8RO board to interact with any refrigeration system or environmental control component.

The 8RO board is the direct link between the E2 and component operation. Information gathered by the controller from the input boards is checked against current

stored setpoints. If differences in the received input data and the setpoint information are detected, a signal is either sent to the proper 8RO relay, or an existing signal is discontinued. Through the use of this relay signal, control functions that can be properly maintained by a simple contact closure sequence are effectively operated by the E2.

The 8RO board is easily installed and operated within the Retail Solutions Network environment because of its straightforward design. Several of these features are shown in Figure 2-13.

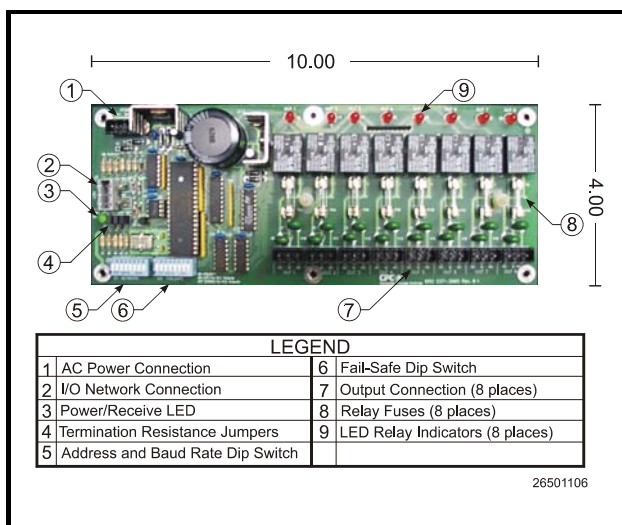

Figure 2-13 - 8RO Relay Output Board

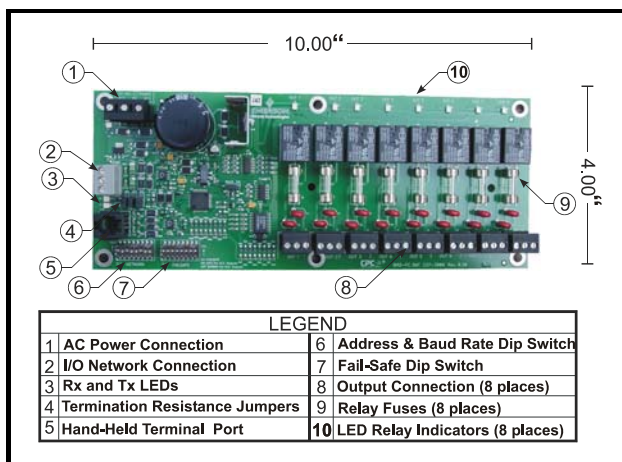

Figure 2-14 - 8ROSMT Relay Output Board

2.2.6 4AO Analog Output Board

The 4AO Analog Output Board (P/N 815-3030) (*Figure 2-15*) is configured with four analog output connections that provide a variable voltage signal to any of four analog devices that may be controlled by a single E2. Two 4-20mA outputs are provided for channels 1 and 2. The 4-20mA outputs provide a variable current for applications that are either externally powered or that require power from the 4AO board.

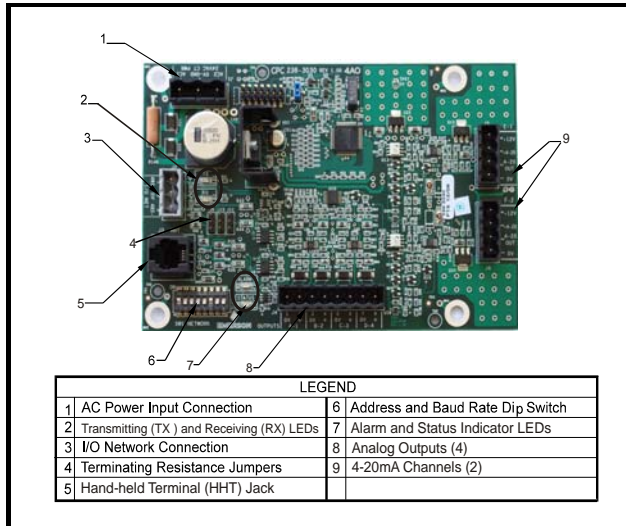

Figure 2-15 - 4AO Analog Output Board (P/N 815-3030)

2.2.7 8DO Digital Output Board and PMAC II Anti-Sweat Controller

For control of anti-sweat heaters, Retail Solutions supplies the 8DO Digital Output board (P/N 810-3050). The 8DO has eight outputs which may pulse up to 150mA at 12VDC.

Since the 8DO is primarily designed to control anti-sweat heaters, the 8DO is the heart of Retail Solutions' Pulse Modulated Anti-Sweat Control (PMAC II) panel. The PMAC II (P/N 851-1000) provides 16 channels of anti-sweat control circuitry. The PMAC II panel combines the 8DO with high-capacity relays in a single enclosure, providing 256 total amps of anti-sweat heater operation.

The 8DO is shown in *Figure 2-16*. The PMAC II is shown in *Figure 2-17*.

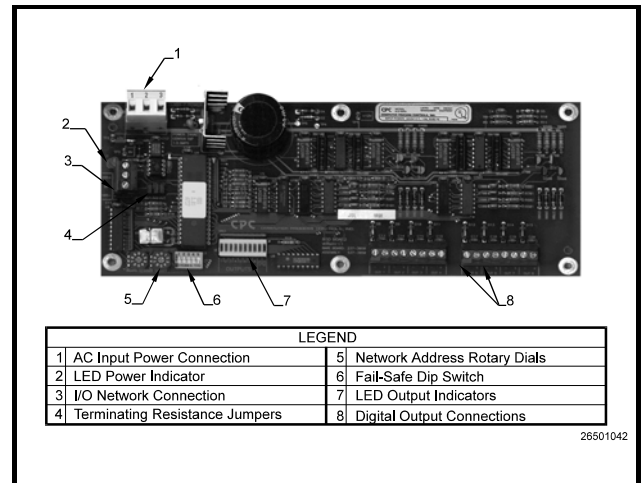

Figure 2-16 - 8 DO Digital Output Board

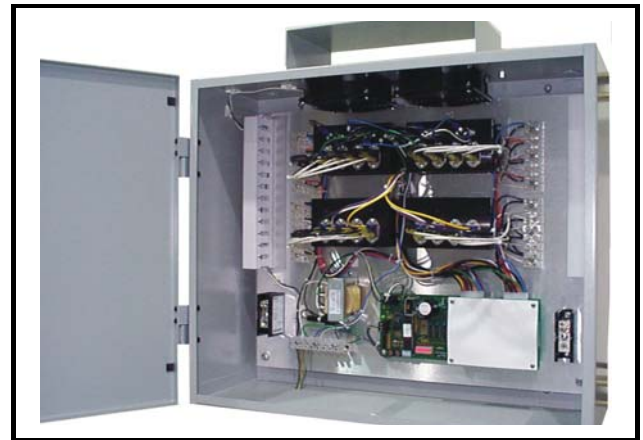

Figure 2-17 - PMAC II Anti-Sweat Control Panel

2.3 Echelon Network Boards and Peripherals

2.3.1 The 16Aie (Discontinued)

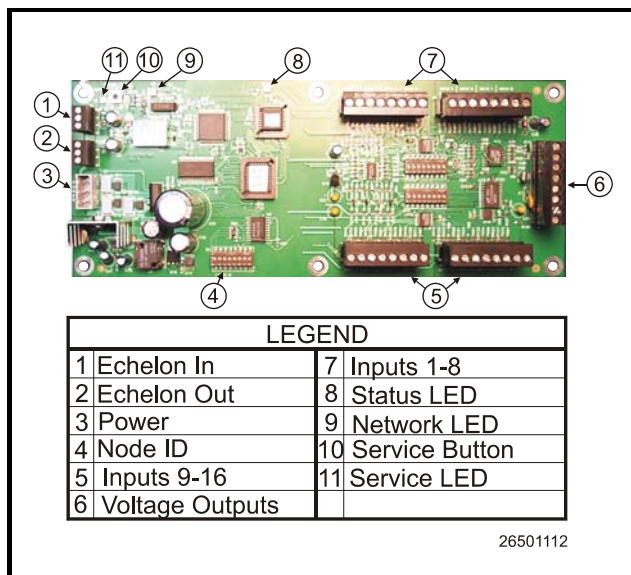

Figure 2-18 - 16Aie

The 16Aie (P/N 810-4000) is an Echelon-based input board similar in function to its I/O Network counterpart, the MultiFlex 16 (see Section 2.2.2). The 16Aie receives input signals through any of 16 two-wire connections. The board receives either digital or analog data from sensors wired to any of the 16 input connections located on the board.

This board has been discontinued and is no longer available for sale.

2.3.2 The 8ROe (Discontinued)

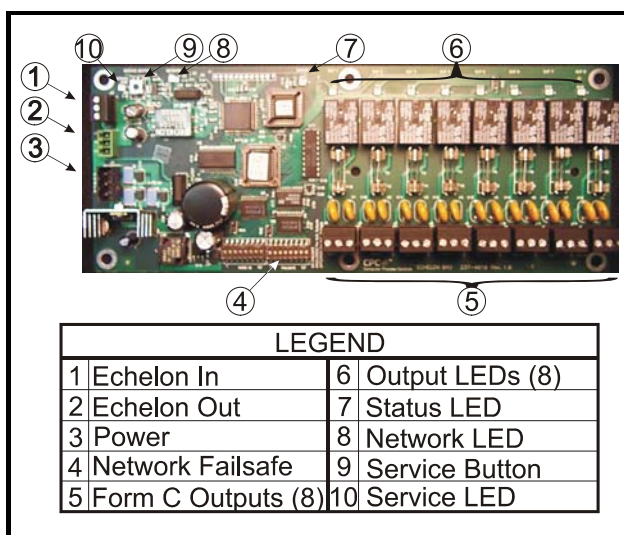

Figure 2-19 - 8ROe

The 8ROe (P/N 810-4010) is an Echelon-based input board similar in function to its I/O Network counterpart, the 8RO. The 8ROe board is the direct link between the E2 and component operation. Information gathered by the controller from the input boards is checked against current stored setpoints. If differences in the received input data and the setpoint information are detected, a signal is either sent to the proper 8ROe relay, or an existing signal is discontinued. Through the use of this relay signal, control functions that can be properly maintained by a simple contact closure sequence are effectively operated by the E2.

The 8ROe features Form C contacts for wiring outputs as either normally open or normally closed. Fail-safe dip switches on the 8ROe allow the installation technician to specify the desired state of each relay in case of communications loss.

This board has been discontinued and is no longer available for sale.

2.3.3 EC-2s

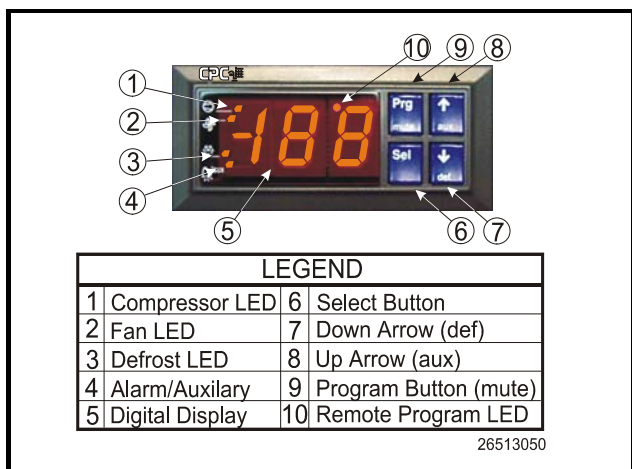

Figure 2-20 - EC-2

The EC-2 is an advanced refrigerated case controller that doubles as a temperature and case status indicator. During refrigeration and defrost, the EC-2 controls most typical case functions, including fans, defrost, and a pulse valve on the liquid side of the evaporator to regulate superheat.

The EC-2 29x version controls the refrigeration solenoid valve to allow the passage of refrigerant to the TXV valve. The EC-2 39x version controls a pulse valve on the liquid side of the evaporator to regulate Superheat control.

The EC-2 relies on a parent E2 to handle logging, alarm control, defrost scheduling, and other case control functions.

The EC-2 is designed to be mounted on the front of a refrigerated case. The LED display shows the current case temperature with one-tenths of a degree's accuracy. The display can also show alarm codes to immediately notify floor managers of alarms and notices. Other lights on the display show the ON/OFF status of refrigeration, defrost, and fans.

The EC-2 can be easily programmed using either the four front-panel buttons or an optional infrared remote control. For security, the buttons can be disabled to prevent tampering.



NOTE: There are several variations of the EC-2. Contact Retail Solutions at 1-800-829-2724 for more information.

2.3.4 CC-100 Case Controllers and CS-100 Case Circuit Controllers

A CC-100 case control board is a “smart” board capable of controlling all functions for a single case, including

lights, fans, defrost, anti-sweat, and suction side or liquid side valve control. CC-100s perform these functions independently from the E2 RX controllers, but it does rely on a parent E2 for logging, alarming, providing supplemental I/O values, and coordinating defrost times among circuits.

There are four different models of the CC-100, each of which controls a different type of valve.

1. **CC-100P** (P/N 810-3160)— Case controller for liquid-side pulse valves (also called electronic expansion valves, or EEVs). This model is capable of controlling up to two pulse valves simultaneously (for use in dual-evaporator applications such as walk-in boxes).
2. **CC-100LS** (P/N 810-3170)— Case controller for liquid-side stepper valves (EEVs).
3. **CS-100** (P/N 810-3177)— Case circuit controller for suction-side stepper valves (also called electronic evaporator pressure regulators, or EEPRs).
4. **CC-100H** (P/N 810-3171)— A special version of the CC-100 that is used by a particular manufacturer. This board controls temperature in a case using suction-side stepper valves that regulate pressure in the evaporator.

The CC-100/CS-100 board is shown in *Figure 2-21*.

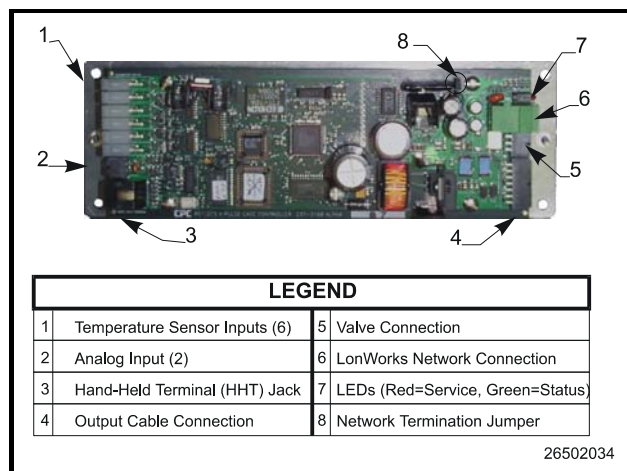

Figure 2-21 - Case Controller (CC-100P shown)

2.3.5 TD3 Temperature Display

The TD3 is a digital display unit designed to show both case temperature and product temperature for a refrigerated store case or walk-in freezer. The TD3 mounts on the front of a case and connects to up to three input devices (a case temperature sensor, a product temperature probe, and either a defrost termination probe or thermostat). The real-time input values of these probes can be viewed on the TD3's digital display by pressing the function button on

the front panel to cycle through the temperatures.

The TD3 is connected to a central E2 RX controller via the Echelon Network. Input values are sent to the E2 from the TD3 for use in case circuit control.

A diagram of the TD3 layout is shown in *Figure 2-22*.

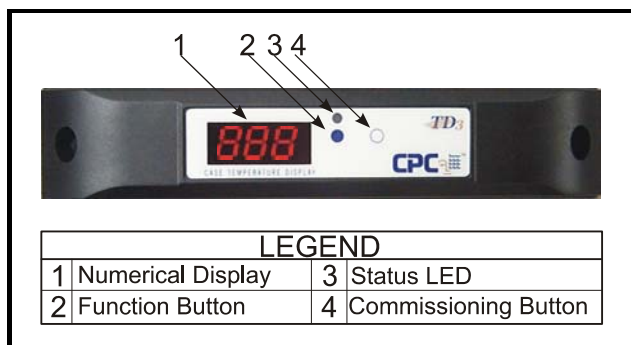

Figure 2-22 - TD3 Temperature Display Layout

2.3.6 Facility Status Display (FSD)



Figure 2-23 - Facility Status Display

The FSD reports alarm information and more, (such as temperatures, occupancy, case status, and setpoints) and provides a centralized device for store personnel to review information by communicating with the E2 via Ethernet connectivity (minimum E2 firmware rev. 2.68F01).

The FSD has a touch screen color display for quick navigation and can be mounted in a separate, remote location from the E2 controller, which enables alarms and other relevant store information to be viewed from where it is most convenient for the user.

The FSD can be configured to filter out notices and/or return-to-normal alarms, and provides a quick review of all advisories and detailed advisory information. The FSD also receives alerts and provides annunciated alarms and alarm information directly to store and department managers. This compact unit can be installed virtually anywhere with a standard Ethernet connection and 120V power source.

If more than one E2 controller is at a site, one E2 must be set up as the alarm annunciator for that site. The FSD will receive alarms from that alarm-annunciator E2 for the entire site. The FSD will point only to a single E2 at a site (it will not poll multiple controllers for alarms).

For more information, refer to the FSD Manual (P/N 026-1400).

3 Mounting

This section gives mounting instructions and dimensions for all controllers and peripherals in the E2 system.

3.1 Mounting the E2

The E2's box body style is designed to be mounted against or inside a wall or panel. If mounted against a surface, the controller will be 3.75" off the mounting surface. If mounted inside a surface, the door and front section of the back panel will rest 2.0" off the mounting surface. See *Figure 3-1*, and *Figure 3-2*.

3.1.1 Standard Mount

The standard mount is meant for the controller to be mounted against a wall using the four mounting holes at the rear of the enclosure shown in *Figure 3-3*. These holes are accessible without any removal of boards inside the enclosure.

3.1.2 Recessed Mount

The recessed mount is meant for the controller to be bolted against a surface using the eight mounting holes. The unit may be mounted with the recessed back portion of the unit inside the wall, and the front portion of the unit visible through the hole in the wall (*Figure 3-1* and *Figure 3-4*).

For a recessed mount, you will need to cut a rectangular hole into the mounting surface 9.0" wide by 10.5" high (22.86 cm wide by 26.67 cm high). Once this hole is cut, mount the unit as desired using the eight outer mounting holes shown in *Figure 3-1* and *Figure 3-4*.

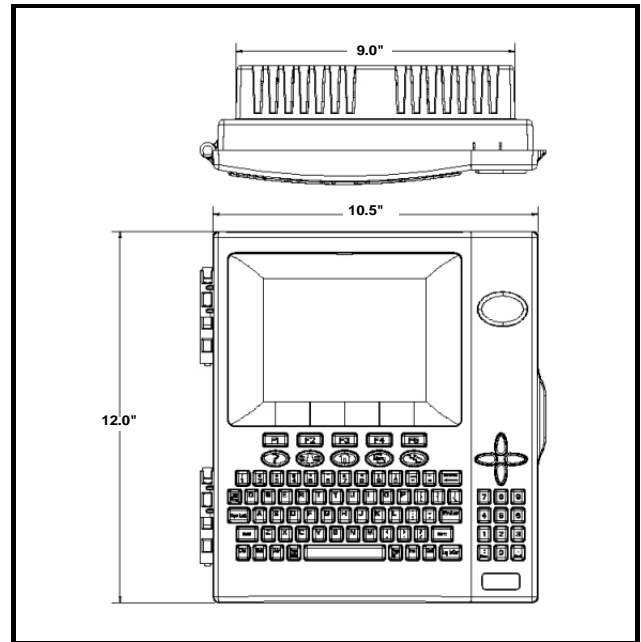

Figure 3-1 - E2 Front and Top Dimensions

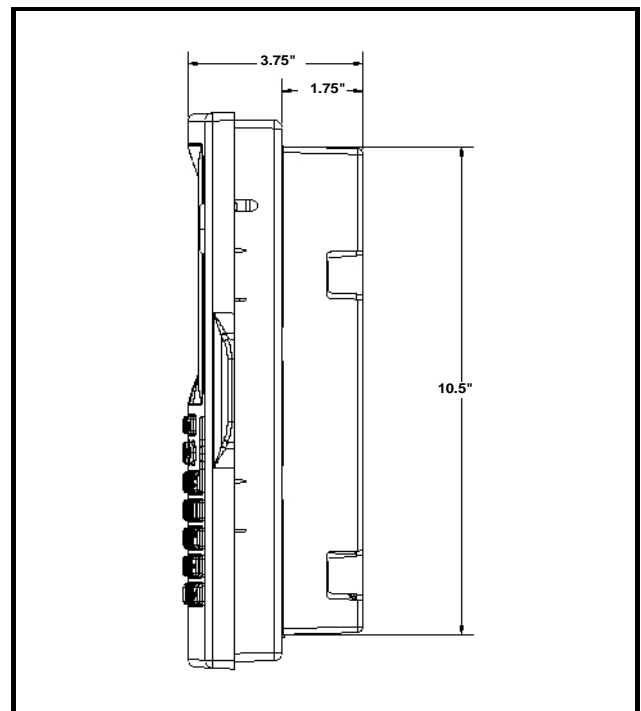

Figure 3-2 - E2 Side Dimensions

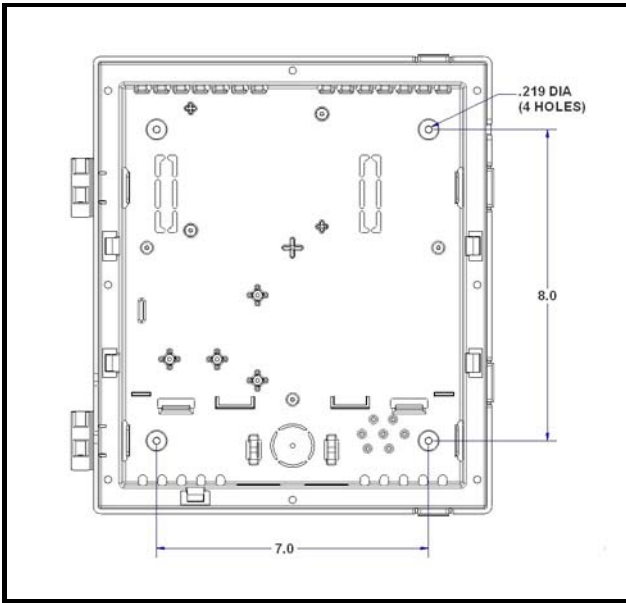

Figure 3-3 - Standard Mount (Inside Rear of Enclosure)

to the cut out (four screws and four nuts are included), but the plate is equipped with a total of 14 holes for the best possible fit.

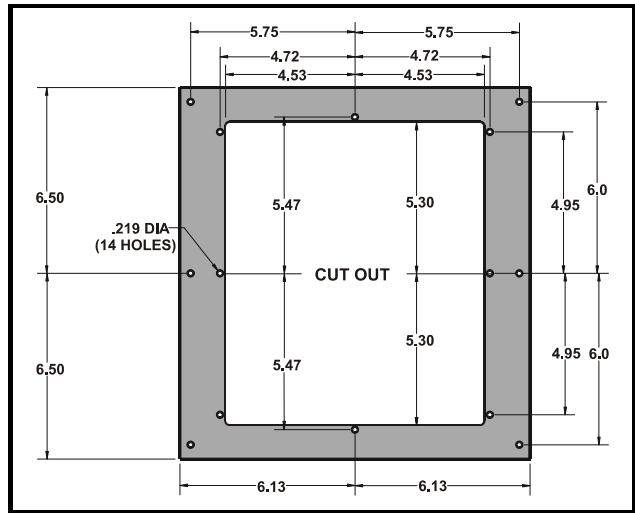

Figure 3-5 - Conversion Plate for Flush Mount

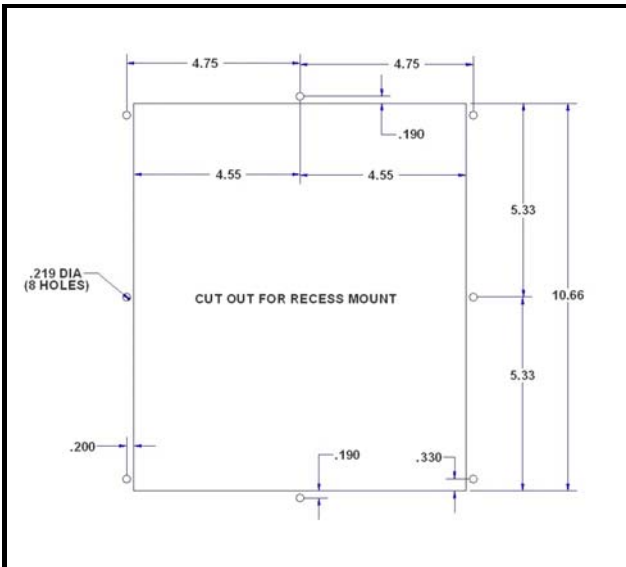

Figure 3-4 - E2 Recess Mount Hole Locations

3.1.3 Retrofit Mounting

The retrofit mounting plate and bracket allow the E2 to be mounted where previous generation controllers (Einstein or REFLECS) were. These two options allow conversion of the flush-mounted Einstein and the side-mounted REFLECS.

Figure 3-5 shows the low-profile conversion mount plate that allows a flush-mounted Einstein to be converted to a low-profile mount. The plate slides over the back of the E2 and is attached using the four holes pictured closest

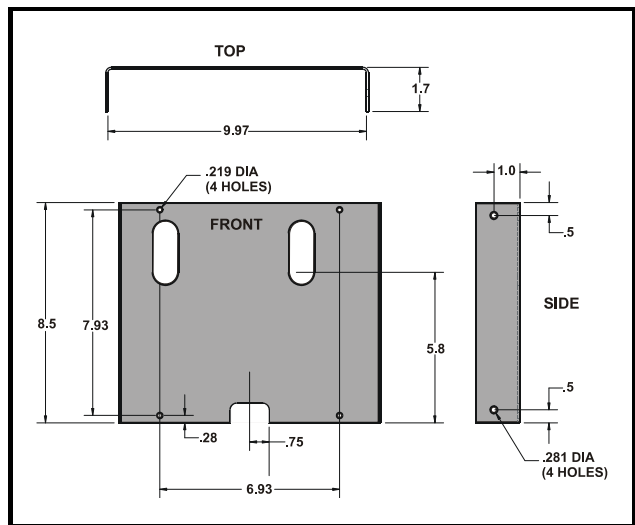

Figure 3-6 - Conversion Bracket for REFLECS Side Mount

Figure 3-6 shows the conversion bracket that allows a side-mounted REFLECS to be converted to a side-mounted E2. The conversion bracket is attached to the back of the E2 using the two holes at the top and bottom of the bracket, and aligning the oval openings with the oval cut-outs in the back of the E2 case. Once the E2 is attached to the conversion bracket, use the two holes in either side of the conversion bracket (depending on which side is needed) to mount the E2 to the wall and replace the REFLECS controller.

3.1.4 Blank Face

Blank face control is designed to be used in a system with more than one E2. It has no screen or keyboard and is logged into remotely from another E2 on the Echelon network. The green General Status LED transmits status information to the user. See *Table 2-3 on page 2-3* for more information on main board (CPU) status LEDs. Blank face mounting dimensions are identical to the standard and recessed mount boxes. See *Figure 3-3* and *Figure 3-4*.

3.2 Mounting I/O Boards

The 16AI, 8RO, 8DO, 4AO, 8IO, and MultiFlex boards are usually installed by the refrigeration or building equipment manufacturer. Therefore, the installer need only make the necessary connections between the E2 and the cases, condenser boards, and/or HVAC units.

In some instances, an installer may be required to mount an I/O board. There are no restrictions on the location of these boards; however, for ease of network configuration, it is recommended that the boards be located adjacent to the E2. I/O boards may be mounted without an enclosure, but they should be mounted in a location that is not easily accessible to avoid tampering or damage.

3.2.1 Single/Double Enclosures

The Single enclosure and Double enclosure are supplied with four mounting holes in the rear panel of the enclosure. The mounting holes can be accessed without removing any of the boards inside the enclosure. *Figure 3-7* shows the dimensions and weight for the Single enclosure. *Figure 3-8* shows mounting dimensions for the Double enclosure. When mounting boards inside the enclosure, refer to *Figure 3-9* for mounting dimensions

for the MultiFlex, 16AI, 8RO, and the 8DO.

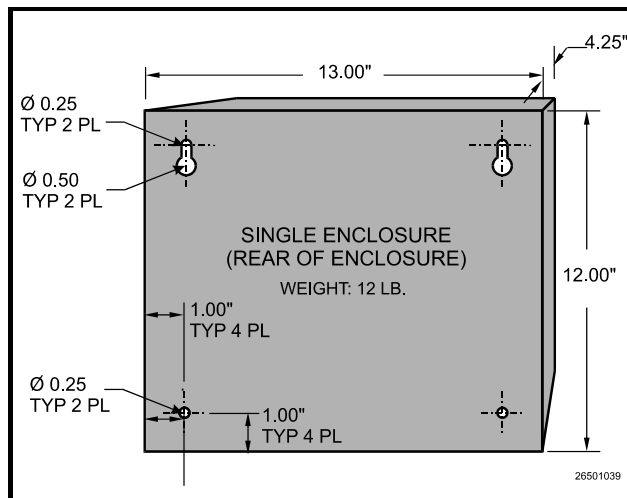

Figure 3-7 - Single Enclosure Mounting Dimensions

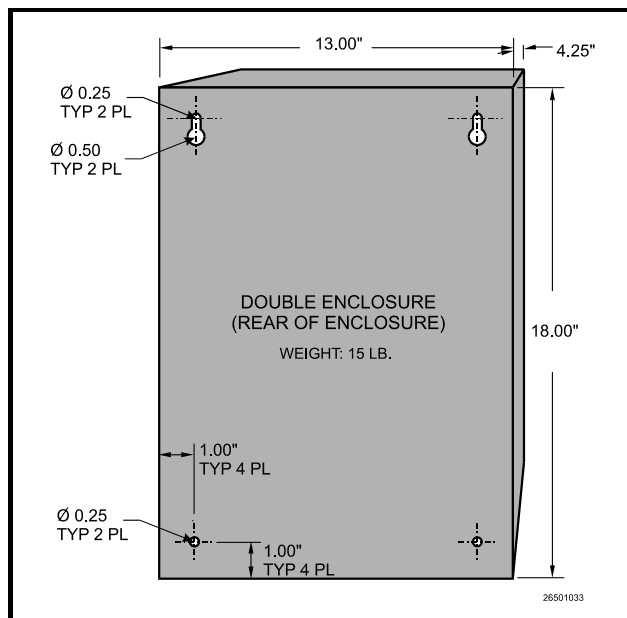

Figure 3-8 - Double Enclosure Mounting Dimensions

3.2.2 Boards Without Enclosures (Snap Track)

16AI, 8RO, 8DO, and Gateway boards not supplied with an enclosure are supplied with a snap-track for easy installation. The insulation sheet and I/O board must be removed from the track before the track is mounted. The snap-track is mounted using the 0.1875" mounting slots. **Figure 3-10** shows this installation procedure.

Figure 3-9 provides mounting dimensions for the MultiFlex, 16AI, 8RO, and the 8DO boards. **Figure 3-11** provides mounting dimensions for the 4AO.

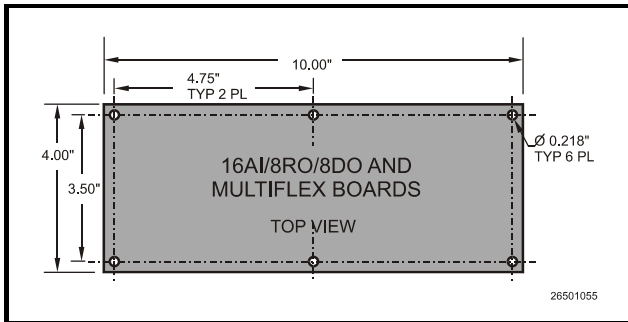

Figure 3-9- 16AI/8RO/8DO Mounting Dimensions

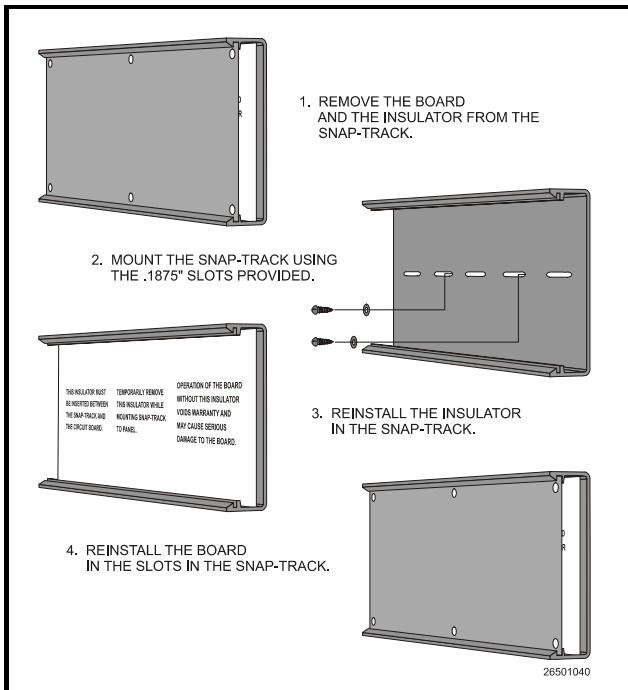

Figure 3-10 - 4AO, 8RO, or MultiFlex Snap-Track Installation

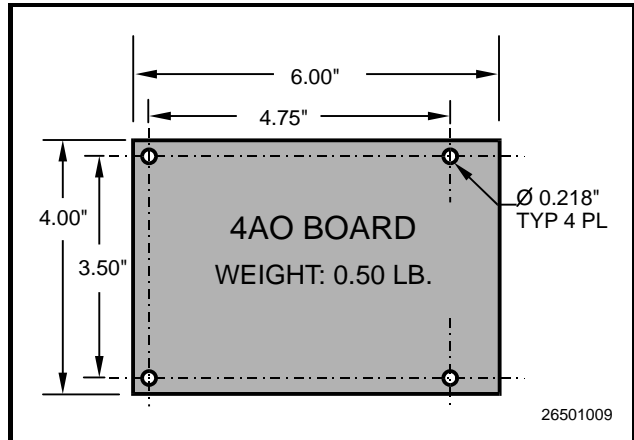

Figure 3-11 - 4AO Mounting Dimensions

The Gateway is typically mounted in the same area as the site controller, near the controller's 16AI, 8RO, and other RS485 Network peripherals. The Gateway is designed to fit into a standard 3" snap track (supplied with the board) or may be mounted in a panel or on stand-offs. Follow the dimensions in **Figure 3-12** for panel mounting.

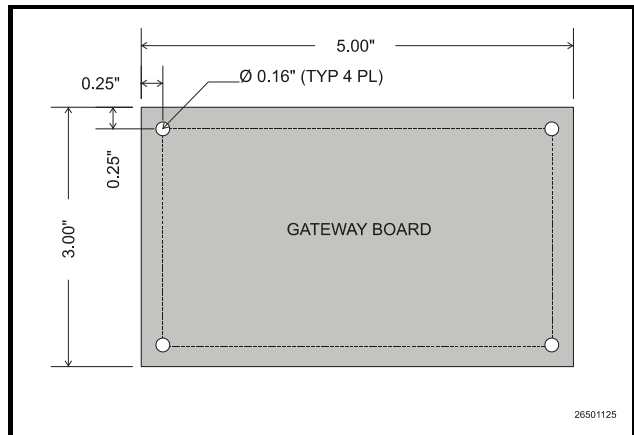

Figure 3-12 - Gateway Board Mounting Dimensions

The Gateway should be mounted in an environment with ambient temperature between -40°F and 150°F, with a non-condensing relative humidity between 5% and 95%.

3.3 Echelon Devices

3.3.1 CC-100 Case Controller and CS-100 Case Circuit Controller

Generally, the case controller will be mounted within the raceway or on top of the case. If a controller must be replaced or installed in the field, it should be located based on the specific design of the case.

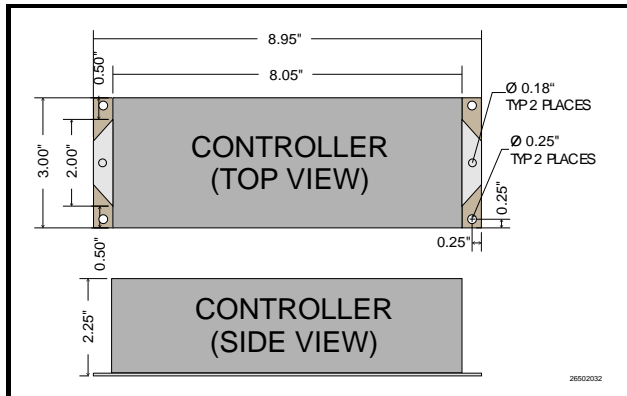

Figure 3-13 - CCB Mounting Dimensions

3.3.2 MultiFlex ESR

The MultiFlex ESR is supplied with a snap-track. If the ESR8 is supplied without an enclosure, it is supplied with 0.500" long metal stand-off dowels that are pressed into the mounting holes in the board.

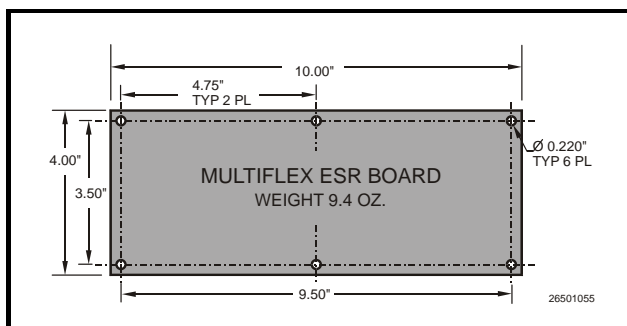

Figure 3-14 - Mounting Dimensions for the MultiFlex ESR

3.3.3 TD3

The TD3 temperature display is almost always mounted by the OEM as part of the construction of the refrigerated cases. As such, field installations of TD3s are rare.

TD3s are typically flush mounted on the front of a refrigerated case in such a way as to be fully visible from the sales floor. A hole one inch in diameter must be drilled into the case to allow the TD3's wiring harness to extend

into the case and connect to the network, the power source, and the case-mounted probes. Figure 3-15 shows the mounting dimensions of the TD3.

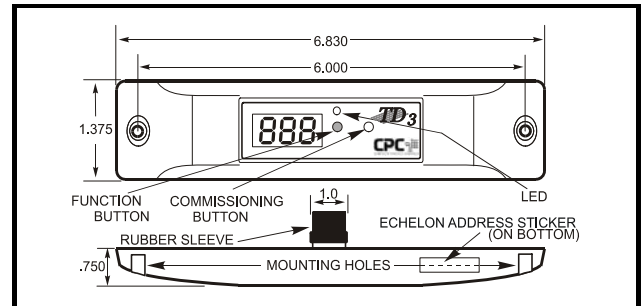

Figure 3-15 - TD3 Mounting Dimensions

3.4 Modem/Communication Expansion Card Mounting

The E2's modem/communication expansion card mounts above the PIB in the back of the enclosure box as shown in Figure 3-16. The standoffs and mounting holes are located above the PIB in the back of the enclosure box. Use the mounting screws and standoffs to secure the card in place. The ribbon cable plugs into the "Modem/Com 6" slot on the motherboard. For more information on the modem/communication expansion card, see Section 4.3.1, *Echelon Plug-in Card (P/N 537-4860) with mounting screw (P/N 101-4201)*.



Figure 3-16 - Modem/Comm Card Mounting in E2



NOTE: Because the modem/communication expansion card and four-channel repeater card share the same mounting platform, they must be used separately.

3.4.1 Two-Channel and Four-Channel Repeaters

3.4.1.1 Mounting Repeaters Overview

Repeaters are used to extend the maximum length of a segment of Echelon cable, or to act as a bridge between two devices that are farther apart than the cable's maximum node-to-node distance. Retail Solutions offers two versions of repeaters for the E2 controller: an external two-way repeater that comes in an enclosure (P/N 832-1010), and a four-channel repeater mounted in the E2 (P/N 832-4830).

For more information about installing repeaters and routers, please refer to the *Repeater and Router Installation and Networking Guide* (P/N 026-1605).

3.4.1.2 Mounting the Two-Channel Repeater

The external repeater (P/N 832-1010) is externally mounted within its own enclosure.

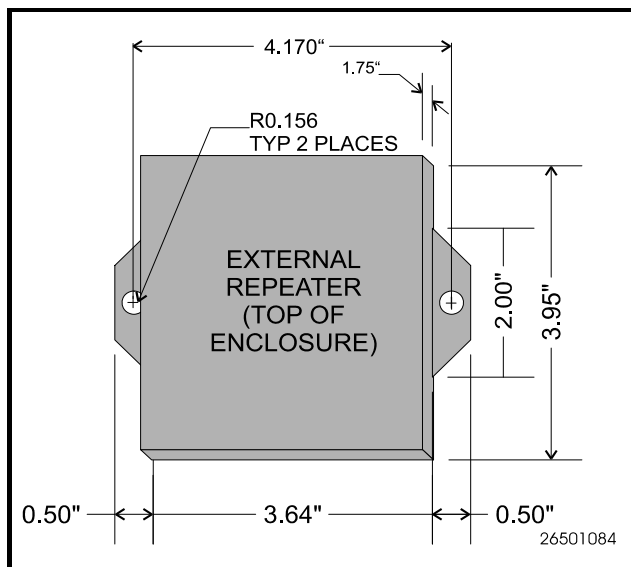

Figure 3-17 - External Repeater Mounting

For external repeaters, the mounting bracket at the bottom of the enclosure has two 0.156" bolt holes on either side. Use the bolt holes to mount these repeaters in the field as necessary (see *Figure 3-17*).

When mounting external repeaters, keep in mind that they require a 24VAC Class 2 power source in order to operate. This will likely require a transformer such as P/N 640-0041 (110V) or P/N 640-0042 (220V) to be mounted near the external repeater enclosure. Make sure there will be enough space next to the repeater to mount the transformer.

3.4.1.3 Mounting the Four-Channel Repeater

The four-channel repeater (P/N 832-4830) serves the same basic function as the two-channel repeater: boosting signal strength. However, the four-channel repeater is also useful as a means of connecting the E2 to its associated devices using more than one daisy chain.

With a four-channel repeater mounted in the E2, you can run as many as three daisy chain segments out into the field, each of which can be as long as the prescribed Echelon maximum wire length. The fourth channel of the repeater can be used to connect other E2s in a separate daisy-chain, eliminating the need to run cable from the field back to the next E2.

The standoffs and mounting holes are located above the PIB in the back of the enclosure box. Use the mounting screws and standoffs to secure the four-channel repeater in place, and connect the repeater to the PIB with the two-pin power connector located next to the battery.



NOTE: Because the modem/communication expansion card and four-channel repeater card share the same mounting platform, they must be used separately.

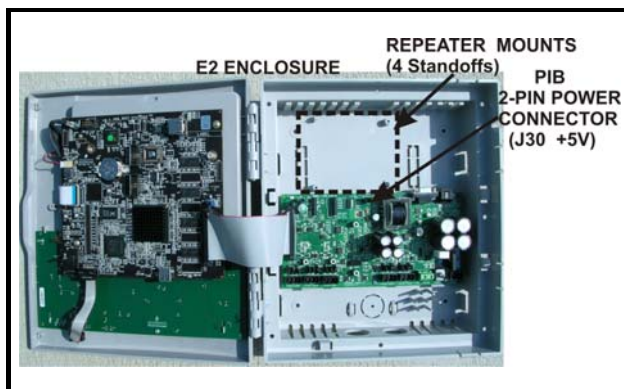

Figure 3-18 - E2 Repeater Mounting

3.5 Sensors and Transducers

3.5.1 Pressure Transducers

Retail Solutions transducers convert pressure readings to proportional electrical signals between 0.5 and 4.5 volts. The transducer is designed with a 1/8-inch male FPT fitting for connection to a standard access fitting. If the fitting is configured with a Schrader valve, this fitting will have to be removed and replaced with a 1/8-inch female fitting. Each pressure transducer is supplied with 20 feet of cable for connection to a 16AI input board.

3.5.1.1 Mounting

The pressure transducers should be mounted in a vertical position (pressure port down) above crank case oil level to prevent drainage of oil into transducer port.

3.5.2 Inside Temperature Sensor

3.5.2.1 Location

Inside temperature sensors are supplied within a wall-mounted enclosure for attachment to a standard switch plate.

The temperature sensor should be located in a central location—within the zone to be measured—away from doors, windows, vents, heaters, and outside walls that could affect temperature readings. In addition, the sensor should not be mounted above other sensors that generate heat during operation (such as relative humidity sensors).

The indoor temperature sensor should be between four and six feet from the floor.

3.5.2.2 Mounting

Mount the sensor using the screws provided as shown in *Figure 3-19*.

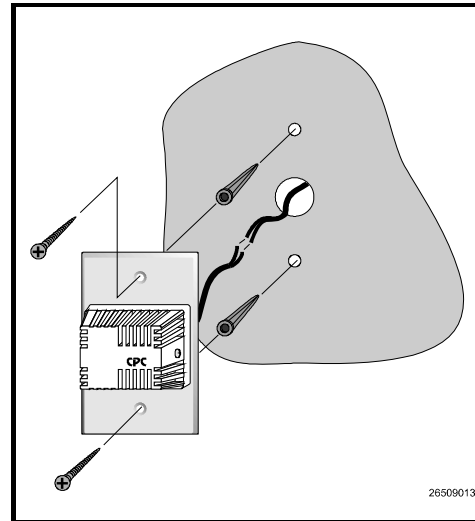

Figure 3-19 - Inside Temperature Sensor Mounting

3.5.3 Outside Temperature Sensor

3.5.3.1 Location

The outside or ambient temperature sensor should be located on the north side of the building, preferably under an eave to prevent sun-heated air from affecting the temperature of the sensor.

3.5.3.2 Mounting

The temperature sensor may be mounted using any standard tubing clamp. Retail Solutions also offers an aluminum cover and clamp (P/N 303-1111) which may be mounted as shown in *Figure 3-20* (fasteners are not provided).

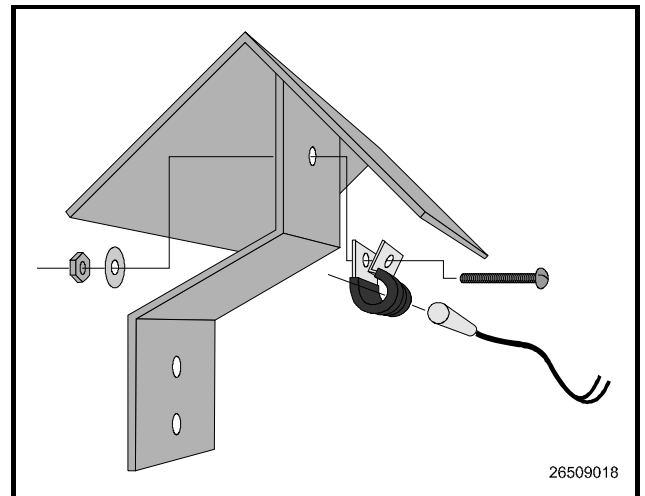

Figure 3-20 - Outside Temperature Sensor with Cover and Clamp

3.5.4 Insertion Temperature Probe

3.5.4.1 Location

The 12-inch insertion temperature probe may be used to monitor temperature in either the supply or return air ducts of the AHU or RTU.

3.5.4.2 Mounting

The insertion probe may be mounted in any orientation within the duct as long as the probe is in the air flow of the duct. The probe housing should be secured using self-tapping screws. A 0.250" diameter hole is required for the probe. **Figure 3-21** shows the installation of the insertion probe (self-tapping screws are not provided).

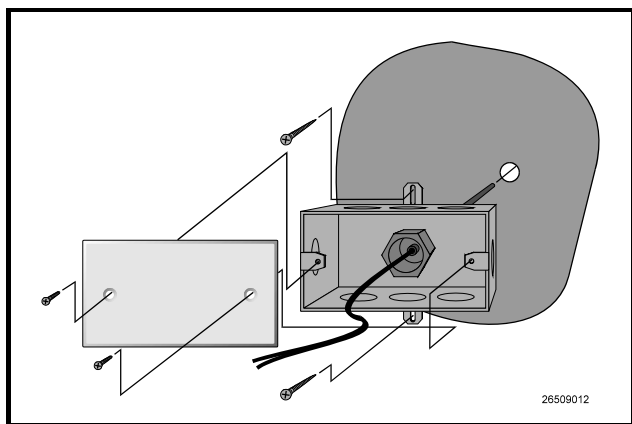

Figure 3-21 - 12-Inch Insertion Probe Mounting

3.5.5 Supply and Return Air Sensors

In addition to the 12-inch insertion temperature probe, Retail Solutions uses the same temperature sensor used for outside and inside temperature to monitor supply and return air temperature. When used in this application, the sensors are supplied without enclosure covers. The sensors should be mounted directly in the air stream of the supply or return air duct. The sensors are not supplied with any mounting hardware for this application.

3.5.6 Refrigeration System Temperature Probes and Sensors

3.5.6.1 Location

Retail Solutions supplies several temperature monitoring devices including bullet sensors, pipe mount sensors, immersion probes, insertion probes, and sensors for high temperature applications. Each of these sensors is generally installed on the system by the equipment manufacturer. If a device must be added to the system, refer to the information supplied with the device and consult the refrigeration equipment manufacturer. **Table 3-1** lists some

typical sensor applications and the sensor or probe most suited for that purpose.

Application	Sensor Type
Condenser Outlet (Drop Leg)	High Temperature Bullet
Liquid (Manifold)	Pipe Mount
Suction Temperature	Pipe Mount
Discharge Air	Bullet
Ambient Temperature (Outside)	Bullet
Condenser Sump	Insertion Probe
Defrost Termination	Bullet

Table 3-1 - Sensor Application and Type

3.5.6.2 Mounting Bullet and Pipe Mount Sensors

Bullet or pipe mount sensors mounted on refrigerant lines should be secured with a Panduit low temperature cable tie, number PLT2S-M120, or equivalent. For pipe mount sensors, the curved surface should be placed against the pipe and the tie should be positioned in the groove on the top surface of the sensor. A second tie should be used to secure the lead to the pipe for additional support.

Sensors located on refrigerant lines should be insulated to eliminate the influence of the surrounding air. A self-adhering insulation that will not absorb moisture is recommended to prevent ice logging at the sensor location.

The sensor should be positioned on the side of the line as shown in **Figure 3-22**.

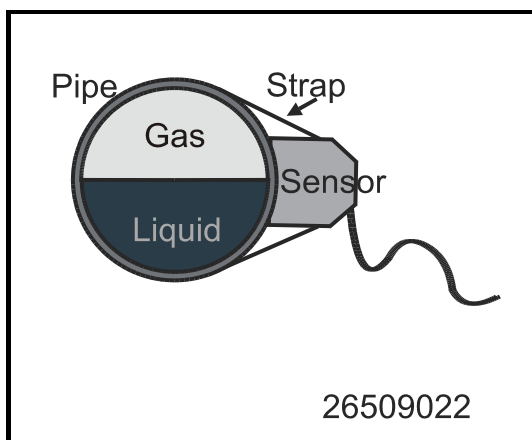

Figure 3-22 - Sensor Orientation

3.5.7 Product Temperature Probes

The product temperature probe is designed to be used

alongside food products in a refrigeration case or freezer. The product probe uses a thermistor type temperature sensor in a sealed, cylindrical container (approximately 16 oz.). A magnet is contained at the bottom the probe's enclosure to allow easy attachment to a side or bottom of a refrigeration case.

3.5.8 Humidity Sensors and Humidistats

3.5.8.1 Indoor RH Sensor

The indoor relative humidity sensor should be mounted in a central location within the zone to be measured, away from doors, windows, vents, heaters, and outside walls that could affect temperature readings. The sensor should be between four and six feet from the floor. Note that this sensor generates a small amount of heat; therefore, do not mount temperature sensors directly above RH sensors.

Mount RH sensor (*P/N 203-5751*) as follows:

1. With a flat-head screwdriver, push down the middle tab on the top of the sensor case and pop the lid off to expose the circuit board.
2. Insert the flat-head screwdriver into the two slots on either side of the top of the sensor case and twist to separate the back plate from the case.
3. Remove the knock-outs from the back plate before mounting so wires may be threaded through.
4. Mount the back plate to the wall using the two open mounting holes on the top and bottom of the plate.
5. Replace the cover on top of the back plate by lining up the tabs, and snap the lid back into place.

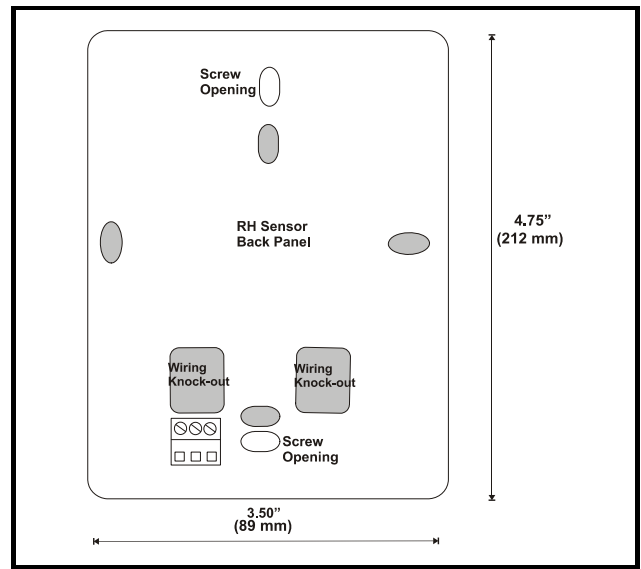

Figure 3-23 - Indoor RH Mounting Dimensions

3.5.8.2 Outdoor RH Sensors

The outdoor RH sensor (*P/N 203-5761*)

The outdoor RH sensor (*P/N 203-5761*) should always be mounted on the north side of the building if in the Northern Hemisphere, or on the south side if in the Southern Hemisphere. The sensor should be mounted under an overhang or otherwise out of direct sunlight (if possible).

Mount the RH sensor (*P/N 203-5761*) as follows:

1. Secure the rear side of the enclosure to the outside wall using the two mounting brackets, as shown in **Figure 3-24**. The tube holding the sensor element should point straight down.
2. If you will be running the sensor cable through the wall behind the sensor, cut or drill a hole in the wall through the hole in the enclosure.

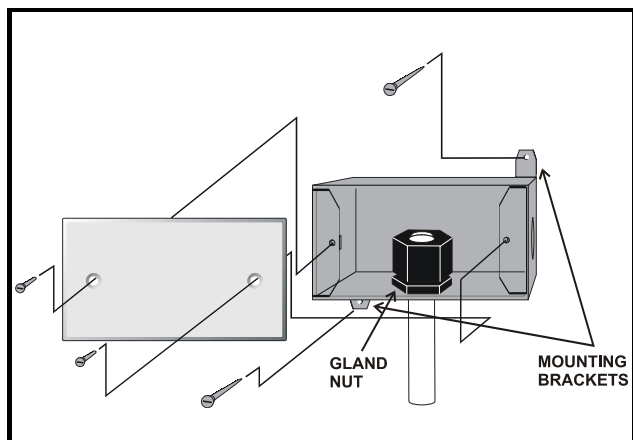

Figure 3-24 - Outdoor RH Sensor - Exploded View

3.5.8.3 Duct-mounted Insertion RH Probe

Retail Solutions specs a duct-mounted relative humidity (RH) sensor (P/N 203-5771) with a 0-5VDC output for use in building control and anti-sweat control applications using Retail Solutions input boards.

1. Cut a small circular hole in the duct large enough for the sensor tube to fit through.
2. Bolt the sensor enclosure against the outside of the duct wall so that the sensor element fits through the hole and into the duct. The enclosure may be mounted horizontally, as shown in *Figure 3-25* or vertically. The screws should be tight enough for the foam gasket around the bottom of the sensor to form an airtight seal between the hole in the duct wall and the outside air.

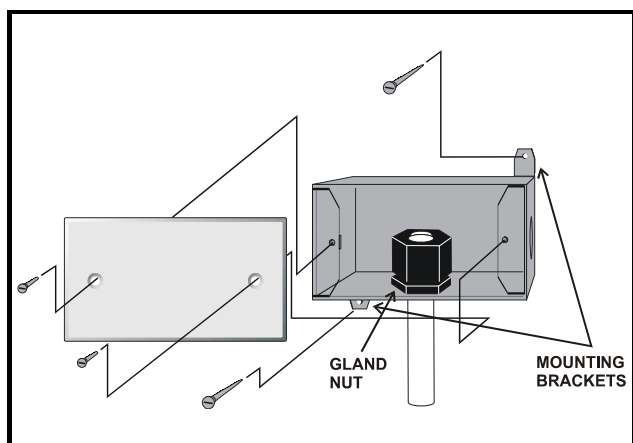

Figure 3-25 - Duct-mounted RH Sensor - Exploded View

3.5.9 Dewpoint Probe

3.5.9.1 Location

The Dewpoint Probe (P/N 203-1902) should be located 4 to 6 feet from the floor with the probe pointing up. It is recommended that the Dewpoint Probe be mounted in an area where it will be exposed only to minimal amounts of dust.

3.5.9.2 Mounting

Mount the probe using the standard switch cover supplied with the unit as shown in *Figure 3-26*.

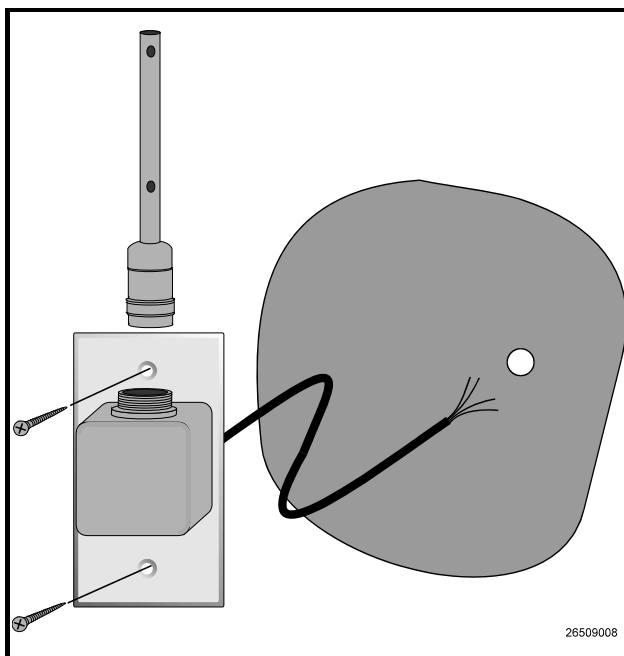

Figure 3-26 - Dewpoint Probe Mounting

3.5.10 Light Level Sensor

3.5.10.1 Location

The Light Level Sensor (P/N 206-0002) should be located facing away from direct sunlight, preferably facing north in the Northern Hemisphere or south in the Southern Hemisphere.

3.5.10.2 Mounting

The light level sensor is not supplied with mounting hardware. The sensor should be mounted horizontally through the knockout of a standard weather-resistant junction box. *Figure 3-27* shows a typical mounting configuration.

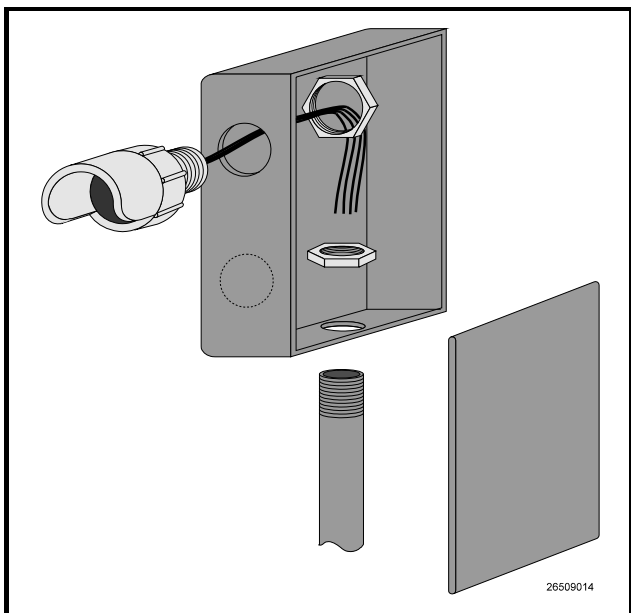

Figure 3-27 - Light Level Sensor Typical Mounting

3.5.11 Liquid Level Sensors

Retail Solutions' probe type liquid level sensor (P/N 207-1000) is usually installed by the refrigeration and equipment manufacturer. If a replacement sensor must be installed in the field, refer to the instructions supplied with the device, or consult the equipment manufacturer.

3.5.12 Refrigerant Leak Detectors

Retail Solutions supplies the Refrigerant Leak Detector System as a stand-alone unit that monitors refrigeration leaks in up to sixteen zones. Consult the *Refrigerant Leak Detector Installation and Operation Manual* (P/N 026-1309) for mounting and installation instructions.

4 E2 Hardware Setup

4.1 Setting up the E2

4.1.1 Enclosure

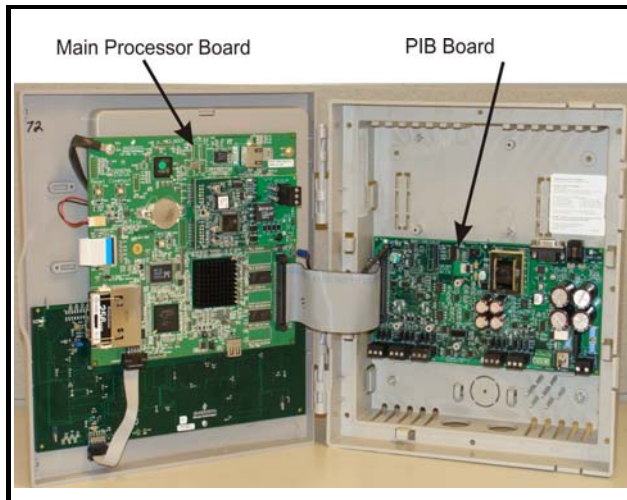

Figure 4-1 - E2 Inside Enclosure

Open the door and expose the main processor board. The main processor board and power interface board (PIB) are mounted side by side, one on each side of the box enclosure.

Note that the door of the E2 controller is not compatible with the previous E2 version. The enclosure doors are not interchangeable.

4.1.2 Main Processor Board

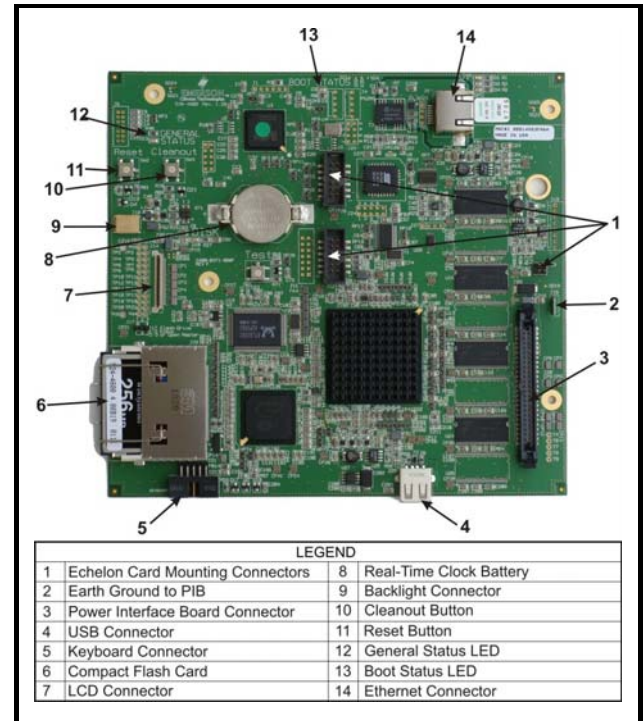

Figure 4-2 - E2 Main Board

The main processor board is mounted on the hinged door part of the enclosure, directly behind the keyboard.

NOTE: E2 enclosure doors are not backwards compatible between E2 units version 3.xx and below and units that are version 4.0 and above. Keep each unit's door with its correct case.

4.1.3 Power Interface Board (PIB)

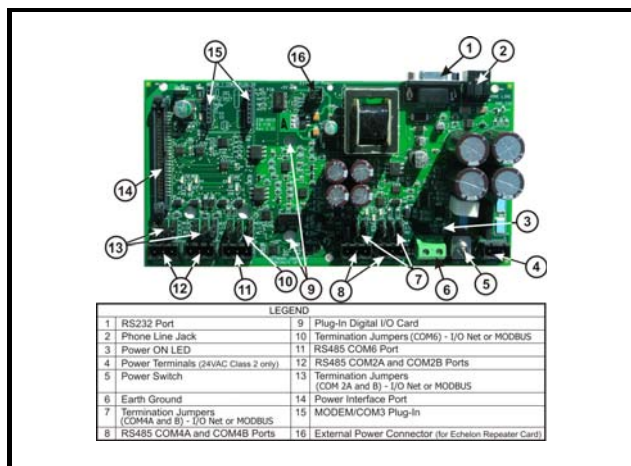

Figure 4-3 - Power Interface Board

The PIB interfaces the power and most all communications with the main board, and contains all field wiring connections.

4.2 Powering the E2

Starting at the lower right side of the PIB, the first plug is the 24VAC input. This must terminate into the power supply transformer.

E2 requires 24VAC Class 2 power, which is supplied by a non-center-tapped Class 2 transformer.

Retail Solutions supplies two transformers that may be used to power E2s: one for use with 110VAC (*P/N 640-0041*), and one for use with 220VAC (*P/N 640-0042*). Both transformers are rated at 50VA, and each will power one E2 unit.

4.2.1 RS485 Ports

On the lower left side of the PIB are two RS485 Network connector ports. This is where all I/O boards (except the case controllers, TD3, ESR8, and Echelon I/O boards) are connected.

4.2.2 RS485 Termination Jumpers (MODBUS or I/O Net)

There is one set of RS485 jumpers for each RS485 port (COM2A-2B; COM6; and COM4A-B). Jumpers J8-J10 are located directly above the COM2A connector port, and jumpers J11-J13 are located directly above the COM2B port. The RS485 termination jumpers (J8-J22) are used to terminate the devices at the beginning and end of an RS485 Network. If the E2 is the beginning of all RS485 I/O or MODBUS Networks, all three of these jumpers

should be set to the UP position. For MODBUS, the jumpers should all be in the top-most position (**MOD**). For I/O Net, the jumpers should be in the middle position (**I/O**). For no termination, set the jumpers to the down position (**NO**).

4.2.3 Echelon Network Connect

The next connector is the Echelon Network plug. The one connector handles both input and output connections. The input and output cables are connected directly to the Echelon plug. This plug is the connection to the Case Controller (CC-100), the Evaporator Stepper Regulator board (ESR8), TD3s, and other E2s.

4.2.4 Echelon Jumper

There is one Echelon jumper (J2) located on the Echelon board that plugs into the main processor board.

Additional information about Echelon Networking and terminating the network can be found in **Section 8.3, Echelon Network Structuring (Daisy-Chains)**.

4.3 Add-On E2 Peripherals

The E2 has many plug-in card options to choose from:

- Plug-in Echelon card with mounting screw
- RS485 Modem/communication expansion card
- Plug-in digital I/O Network card
- Plug-in Four-Channel Internal Repeater

4.3.1 Echelon Plug-in Card (*P/N 537-4860*) with mounting screw (*P/N 101-4201*)

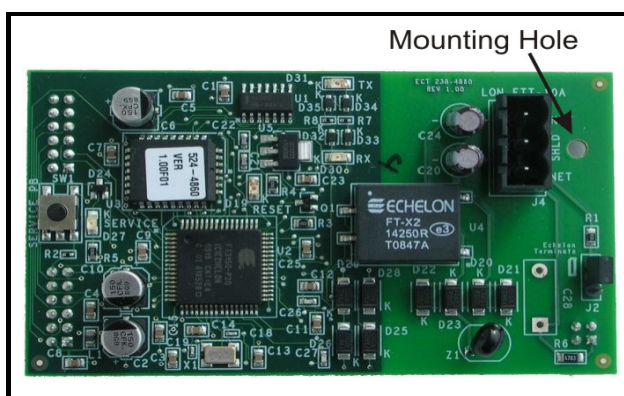

Figure 4-4 - Echelon Card

Echelon is a two-conductor network that interconnects E2s and other associated devices. All Echelon devices are wired together using the daisy-chain method of network

structuring. For the E2 to communicate on the Echelon Network, the plug-in card must be connected. No Echelon Network communication can occur without the card. The plug-in Echelon card connects to the main processor board.

4.3.2 COM3 RS232 Plug-In for External Modem

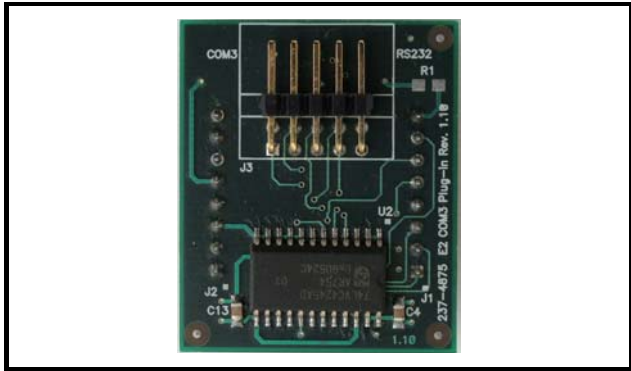

Figure 4-5 - COM3 External Modem

Modem/com expansion card with an RS232 plug-in (COM3) that can interface with an external modem, and an RS485 serial communication port plug-in.

4.3.3 Internal Modem Plug-in Card



Figure 4-6 - COM3 Internal Modem

E2's Serial Configuration is the centralized location where all communication ports (COM ports) may be set up in the E2 controller. To support the increasing number of third-party devices that E2 can communicate with, E2 has the expanded flexibility of dynamic COM ports that will support different types of communication protocols to meet the specific needs of the user.

4.3.4 Plug-In Digital I/O Network Card (P/N 538-4880)

This card adds two user-programmable digital outputs and two digital inputs to enable connection of switches

and relays (relay contacts are rated at 3A up to 24 VAC).

The plug-in Digital I/O Network card connects to the power interface board to the right of the two fixed RS485 I/O Network connectors.

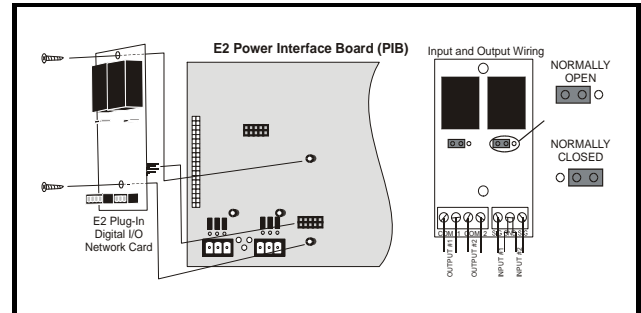

Figure 4-7 - E2 Digital I/O Network Card Install and Wiring

4.3.4.1 LEDs

The plug-in Digital I/O Network card LEDs can be used to determine the status of normal operating parameters for the card.

Plug-In Digital I/O Card LEDs	Status
Red D1 (Out 1)	ON: Relay Output 1 is On
Red D4 (Out 2)	ON: Relay Output 2 is On

Table 4-1 - LED Status for Plug-In Digital I/O Card

4.3.5 Plug-In Four-Channel Internal Repeater

The four-channel repeater (P/N 832-4830) boosts signal strength on Echelon Networks. However, the four-channel repeater is also useful as a means of connecting the E2 to its associated devices using more than one daisy chain.

With a four-channel repeater mounted in the E2, you can run as many as three daisy chain segments out into the field, each of which can be as long as the prescribed Echelon maximum wire length. The fourth channel of the repeater can be used to connect other E2s in a separate daisy-chain, eliminating the need to run cable from the field back to the next E2.

The plug-in Four Channel Internal Repeater card connects above the power interface board on the case mounts using standoffs and screws.

See Section 3.4.2.3, *Mounting the Four-Channel Repeater* for more information.

E2 INSTALLATION GUIDE

1. Connect the I/O or MODBUS Network to one or all of the E2 RS485 I/O or MODBUS Network ports. (A maximum of 31 devices can be wired to each I/O or MODBUS Network port.)
2. For each I/O or MODBUS Network port, set RS485 termination jumpers UP if at either end of a daisy chain. Otherwise, set jumpers DOWN.
3. Connect earth ground to one of the two ground terminals provided. Use 12 AWG (preferred) or 14 AWG wire and keep as short as possible (less than 12 inches preferred).
4. Connect 24VAC to the power terminals.
5. Flip the power switch to the ON position. When 24VAC has been applied to the board, the green LED will illuminate.

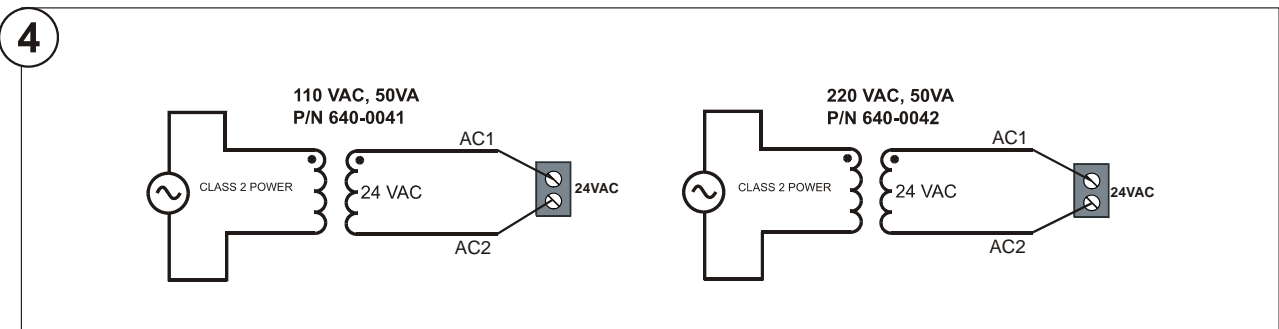
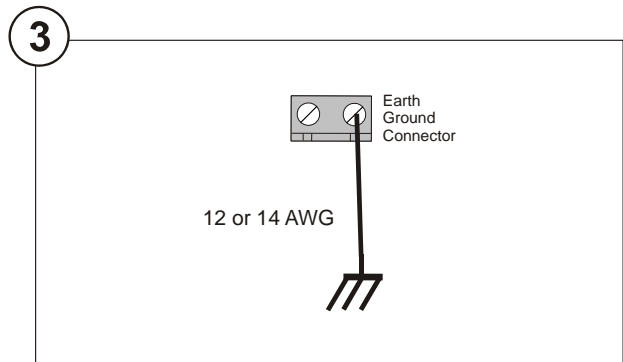
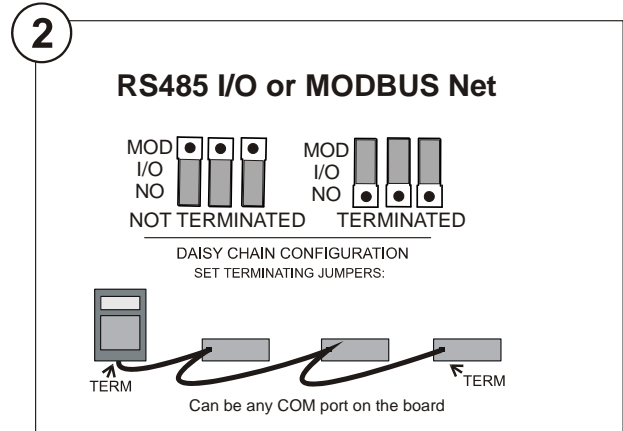
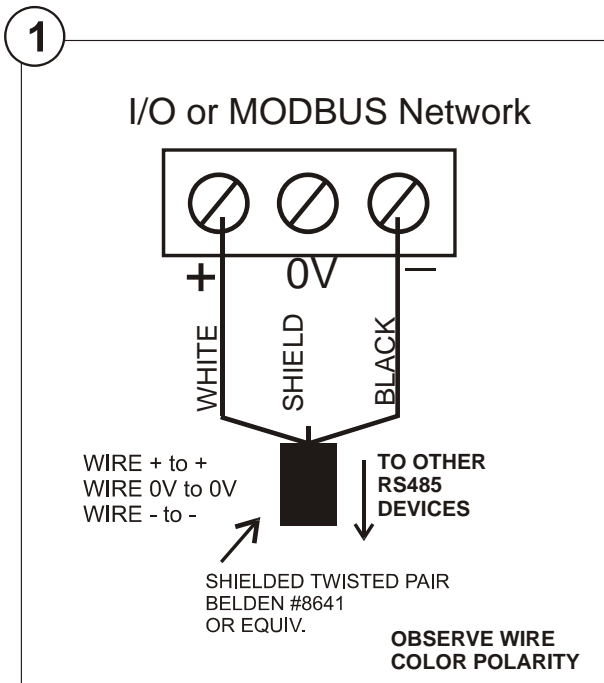
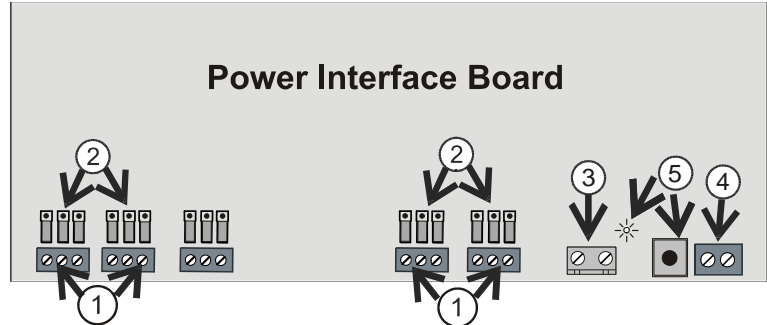

5 Serial Configuration



5.1 Overview

E2's Serial Configuration is the centralized location where all communication ports (COM ports) may be set up in the E2 controller. To support the increasing number of third-party devices that E2 can communicate with, E2 has the expanded flexibility of dynamic COM ports that will support different types of communication protocols to meet the specific needs of the user.

Previously, all COM ports were pre-defined to support a specific type of serial device. E2 now has five configurable COM ports that can communicate with different devices on the network.

5.2 COM Ports

The Serial Connection Manager is located in General Setup under the Serial tab. To access Serial connections to set up the COM ports, press **Alt + M**, or from the E2 Main Menu:

1.  - System Configuration
2.  - System Information
3.  - General Controller Info
4. C3: Serial tab

To begin, first select the COM port you wish to set up, choose the protocol, and set the baud rate.

The user associates the various hardware devices with the COM ports listed under the Serial tab. Five COM ports have user-configurable values such as baud rate and connection type settings.

Pre-Sets

COM1 is pre-set for serial connection. COM3 is pre-set with a modem-only connection type. The COM5 connection is a non-configurable E2 keyboard port.

5.3 Serial Device and Software Setup

After the COM card has been connected to the E2, set up the associated COM port in the Serial Connection Manager:

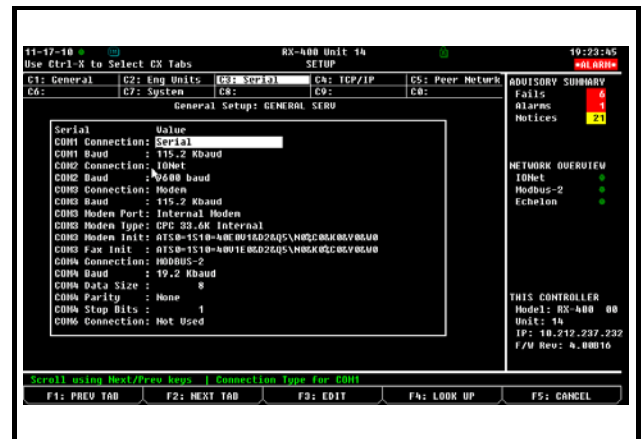

Figure 5-1 - Serial Configuration Screen



NOTE: If a COM card is not connected to the E2, its associated COM port will not be visible in the Serial Configuration screen.

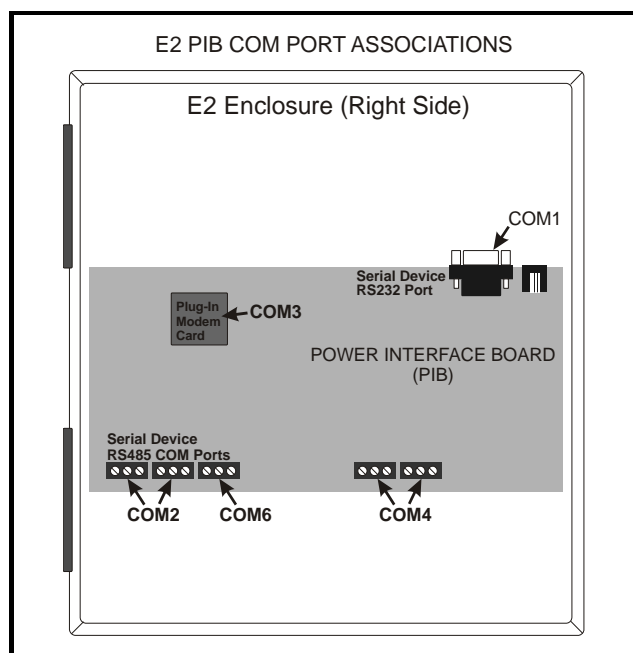

Figure 5-2 - Associated Device Connections and COM Ports

E2COM#	ASSOCIATIONS	CONNECTOR
COM1	COM1 is a pre-set serial connection type (for a PC or laptop) and is located on the RS232 port on the PIB. The baud rate is configurable.	
COM2	COM2 may be configured to the type of serial devices you are connecting: I/O Net (default), ISD 1.0, IMC/Prodigy, or MODBUS 1-3. These devices are connected via the RS485 connectors (for wiring convenience, two connectors are available) on the PIB. The connection type and baud rate are configurable.	
COM3	COM3 is a pre-set connection type for modems only (optional). The E2 modem/expansion communication card (P/N 637-4871) has a plug-in modem that uses the phone line jack (RJ-11). The 637-4872 version has a plug-in for an external modem. Configure the baud rate and modem type for either the internal modem or the external modem.	
COM4	COM4 ports are located on the PIB board. Configure COM4 to the type of device you are connecting: I/O Net, ISD 1.0 (RX unit default), IMC/Prodigy (BX/CX unit default), or MODBUS 1-3. The connection type is configurable.	
COM6	The COM6 port is located on the PIB board. Configure COM6 to the type of device you are connecting: I/O Net, ISD 1.0 (RX unit default), IMC/Prodigy (BX/CX unit default), or MODBUS 1-3. Both connectors cannot be used at the same time. Configure the connection type, baud rate, and parity.	

Table 5-1 - COM Ports with Associated PIB and Card Connections - Refer to Figure 5-2

NOTE: MODBUS can be configured on multiple ports.

6 The RS485 Network and Hardware Setup

Previous versions of E2 hardware and firmware before version 2.30F01 only supported one I/O network port, with an optional expansion card that could be used for connection to Copeland ISD compressors or IMC/Prodigy S-Bus rooftop unit controllers. Beginning with E2 version 2.30F01, E2s now have up to three RS485 network ports, each of which may be configured as an I/O network, IMC/Prodigy, ISD, or ECT MODBUS port.

Section 5, Serial Configuration of this manual covers how to assign COM ports COM2, COM4, and COM6 to different RS485 network types. **Section 6** (this section) explains the network types, the hardware that may be connected to each type, and how to configure the devices.

6.1 The I/O Network

All boards and controllers manufactured by Retail Solutions for communication with E2 via RS485 are generally referred to as **I/O boards**, and the network they are connected to is referred to as the **I/O network** (or **I/O Net**).

A COM port configured as I/O Net may connect with up to 127 I/O boards. This network is used by the E2 to read data from the input boards and to send commands to the analog and digital output boards. Some unit controllers, such as CCB case controllers and MultiFlex RCBs, also communicate with the E2 via the I/O Network.

6.1.1 I/O Board Names and Terminology

There are many input, relay output, analog output, and combination I/O boards available from Retail Solutions for use with the E2. However, separate from the various MultiFlex unit controller models, E2 only recognizes four different types of I/O boards: 16AI, 8RO, 4AO, and 8DO. All E2-compatible I/O boards communicate with E2 as if they are one or more of these types of boards.

In this manual and in the E2 interface, when you encounter these board names, bear in mind that they are terms that represent many types of boards. **Table 6-1** describes all the actual boards or board components for each E2 “board type.”

Board Type	Max #	Translation	Boards That Match Board Type
16AI	16	Any I/O board that has digital and analog inputs. The inputs of a combination I/O board (8IO or MultiFlex combo board) are by themselves treated as one 16AI.	<ul style="list-style-type: none"> •16AI (discontinued) •8IO (discontinued) •MultiFlex 16 •The inputs on all MultiFlex combo boards (88, 88AO, 168, 168AO, and 1616) •All versions of the Gateway board (some versions behave like as multiple 16AIs)
8RO	31	Any I/O board with relay outputs. The relay outputs of a combination I/O board (8IO or MultiFlex combo board) are by themselves treated as one 8RO.	<ul style="list-style-type: none"> •8RO •8ROSMT •The relay outputs on all MultiFlex combo boards (88, 88AO, 168, 168AO, and 1616 (which behaves as two 8RO boards) •8IO (discontinued)
4AO	16	Any I/O board with analog outputs. The analog outputs of a combination I/O board (8IO or MultiFlex combo board) are by themselves treated as one 8RO.	<ul style="list-style-type: none"> •4AO •8IO (discontinued) •The analog outputs on the MultiFlex 88AO and 168AO
8DO	16	Any I/O board with +12VDC digital pulse outputs.	<ul style="list-style-type: none"> •8DO (including all versions of the PMAC and PMAC II anti-sweat controller) •Digital outputs on the MultiFlex 168DO
ARTC/RTU	32	Rooftop HVAC controller board	MultiFlex RTU and ARTC (discontinued)

Table 6-1 - Board Types and Boards Included in Each Type

Board Type	Max #	Translation	Boards That Match Board Type
RCB	32	MultiFlex RCB advanced rooftop unit controller	MultiFlex RCB
PAK	32	MultiFlex PAK rack controller	MultiFlex PAK
CCB	99	CCB case controllers	CCBs
ESR	31	MultiFlex ESR valve controller	MultiFlex ESR
CUB-II	32	Single condensing unit controller (one compressor and up to 4 condenser fans)	MultiFlex CUB II

Table 6-1 - Board Types and Boards Included in Each Type

6.1.2 MultiFlex-Plus (+) Board

The MultiFlex-plus board contains a replacement RS485 transceiver chip that presents less of a load on the network than a non-plus board. This increases the maximum number of devices that can be placed on the network, **but not** the number of board types an Einstein controller can communicate with.

The MultiFlex-plus board now accounts for only 1/8 the load of a non-plus board with 32 total devices on the network (one Einstein controller + 31 boards). This new conversion allows for the placement of 256 devices on the network (one Einstein controller + 255 boards). The number of boards an Einstein controller can support is increased from 31 up to 255 using MultiFlex-plus boards only. In other words, the number of I/O net devices are no longer restricted by the I/O net 31-node limitation.

NOTE: The MultiFlex-plus board replaces the old-style MultiFlex boards and is currently being shipped.

6.1.2.1 Board Designation

Plus boards are always identified with a plus (+) sign that appears on the plastic insulating cover on the top of the board, after the board name.

6.1.2.2 Board Calculations

With X as the number of plus boards and Y as the number of non-plus boards, use the following equation to ensure that the number of devices on your network has not exceeded the maximum load limitation of the network. For

example, if the total number of devices is less than 256, the maximum load limitation has not been exceeded.

$$X + (Y \cdot 8) < 256$$

6.1.3 Wiring Types

Retail Solutions specifies all RS485 I/O and MOD-BUS wiring used by the E2 must be Belden 8641 (24AWG, 300V, Retail Solutions *P/N 135-8641*); Belden 8761 (22 AWG, 300V not stocked by Retail Solutions); or a 600V-shielded 22AWG equivalent stocked by Retail Solutions (*P/N 135-0600*). These are two-connector shielded twisted pair cables that support a maximum daisy chain cable distance of 4000 feet (1219 m) between the E2 and the end device on the network.

6.1.4 The I/O Network Structure (Daisy Chains)

The RS485 Input/Output (I/O) Network connects all input and output communication boards together in a single open communications loop. This loop, or “daisy chain,” connects the E2 to multiple input and output communication boards, and terminates at the last input or output board on the network. A diagram of this network arrangement is shown in *Figure 6-1*.

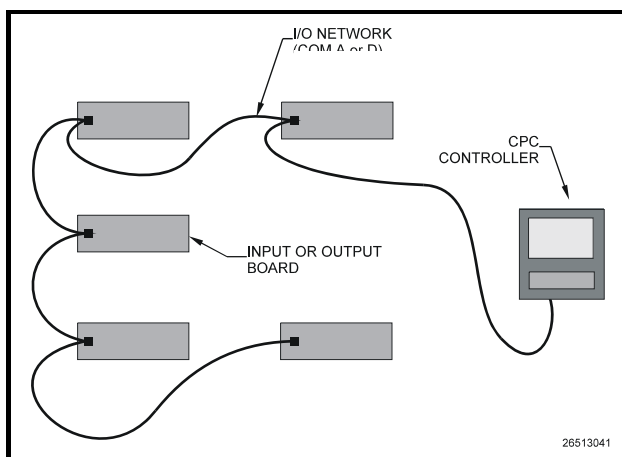

Figure 6-1 - I/O Network Configurations

6.1.5 Network Noise Minimization

Site environments will frequently have numerous sources of high EMI, or “noise,” that must be accounted for when routing RS485 network cable. Although the cable is shielded against noise, the installer must follow best practices for minimizing network noise.

In general, installers should follow these guidelines when installing RS485 networks:

- Avoid running cable next to noise-generating devices, such as motor starters, contactors, inverters, fluorescent light ballasts, arc welders, etc. If possible, keep cable less than 1 foot away from noise-generating devices (ideally, at least 5 feet).
- Do not run RS485 cable in the same conduit as high-voltage wiring, such as 120VAC or 240VAC power wiring. Keep RS485 cable a minimum of 3 inches away from high-voltage wiring (ideally, at least 12 inches). If RS485 must cross paths with high-voltage wiring, cross them perpendicular — running RS485 and high-voltage wire in parallel increases the amount of noise induced on the network.
- Ensure you are grounding each input device's 0V power terminal to a separate earth ground, and setting the termination and biasing jumpers as instructed in **Section 6.1.8, *Setting the Terminating and Biasing Jumpers***.

For more instructions on best practices for minimizing noise, refer to publication *026-1903, E2 Controller Wiring Practices*, available in the Product Manuals section of the Emerson Climate Technologies Web site: www.emersonclimate.com

6.1.6 Network ID Numbers (Board Numbers)

Each device on an RS485 segment has either a network dip switch or rotary dials that must be used to assign the board a unique **network ID number**.

The network ID number makes a board unique from other boards on the network of the same type. This allows E2 to find it and communicate with it easily.

Boards of the same type should be numbered in sequence, starting with one and continuing with two, three, and so forth. For example, if a segment contains four 16AI boards and five 8RO boards, you should number the 16AIs one, two, three, and four; and the 8ROs one, two, three, four, and five. The same should be done with multiple 4AO and 8DO boards, and IRLDS leak detection units.

For all boards, except 8IO and 8DO boards, the network dip switch labeled S1 (or S3 for the 16AI board) is used to set the unique board number of the unit and the baud rate. The 8IO and 8DO uses rotary dials to set the board number of the unit.

Numbering the MultiFlex Combination I/O Boards

When it comes to network numbering, the MultiFlex

Combination Input/Output boards (88, 88AO, 168, 168AO, and 168DO) are special cases. They are actually a combination of three types of Retail Solutions boards: the inputs are configured like a 16AI, the relay outputs are configured like an 8RO, and the analog outputs are configured like a 4AO.

When a MultiFlex combo board is present on the network, it must be addressed like all three board types. Therefore, when numbering these boards, you must set a unique number for both the 16AI, 8RO, and 4AO components of the board.

Addressing the MultiFlex Boards

For MultiFlex boards, set positions 1 to 5 on S3 for the 16AI component and positions 1 to 5 on S4 for the 8RO component. Set positions 6 to 8 on S4 for the 4AO or 4DO segment. For MultiFlex board controllers, use positions 1 to 5 on S3 to set the address.

Addressing the MultiFlex ESR Boards

The MultiFlex ESR uses standard Retail Solutions I/O Network addressing. Set positions 1 to 5 on S1 to set the network ID (address) of the MultiFlex ESR from 1 to 31.

6.1.7 Setting the Baud Rate

All I/O boards have dip switches that determine the baud rate at which they communicate. Currently, the baud rate dip switch in network components may be set at either 4800, 9600, 19200, and 38400. Setting of the baud rate is accomplished using dip switches (refer to the board's installation sheets at the end of this section for specific dip switch settings).

Baud Rate for the E2

The baud rate default for E2 is 9600.

Baud Rate for the Gateway

The Gateway can be set to either 9600 baud or 19.2K baud by dip switch #6. "ON" places the rate at 9600 baud while "OFF" sets it at 19.2K baud.

Dip switches 6 and 7 control the baud rate at which the Gateway communicates with the site controller on the RS485RS485 Network. These switches must be set to the same baud rate setting as the E2 or REFLECS (usually 9600 baud).

Dip switch 8 controls the baud rate at which the Gateway communicates with the other devices on the Receiver Bus Network. This baud rate may only be set to either 9600 baud (switch DOWN) or 19200 baud (switch UP). All Gateways and receivers on the Receiver Bus Network must have the same baud rate dip switch setting. It is recommended you use 9600 baud as the Receiver Bus Network baud rate.

Baud Rate for the 8IO, 8DO, and ARTC

There are three I/O devices that do not have baud rates determined by dip switches. They are as follows:

1. *The 8IO* - this board automatically detects the baud rate being used by the I/O devices on the network, and adjusts to match their baud rate.
2. *The 8DO* - this board automatically detects the baud rate being used by the I/O devices on the network, and adjusts to match their baud rate.
3. *The ARTC* - this board is fixed at 9600 baud.

Baud Rate for MultiFlex Boards

On all MultiFlex boards, switches 6 and 7 on **S3** are used to set the baud rate. To communicate at 9600 baud, set switch #6 to the UP position and #7 to DOWN. For 19200 baud, set switch #6 to the DOWN position and #7 to UP.

Baud Rate for the MultiFlex ESR

Set the baud rate on the MultiFlex ESR board by setting switches 6 and 7 on the network address terminal (labeled **S1**).

To communicate at 9600 baud, set switch #6 to the UP position, and switch #7 to DOWN. For 19200 baud, set switch #6 to the DOWN position and switch #7 to UP. (Currently, 9600 baud is recommended).

Recommended Baud Rate

The baud rate should be set to 9600 baud in all cases.

6.1.8 Setting the Terminating and Biasing Jumpers

The I/O Network connector, for all I/O boards and the E2, has a set of three terminating jumpers. They are the jumpers positioned closest to the I/O Network connector. The E2 has jumpers next to each of the COM ports that can be configured as an I/O network (COM2, COM4, and COM6).

The purpose of the jumpers is to provide network termination resistance and network biasing to the two ends, or termination points, of the daisy chain. One device at the

beginning and one device on the end must be terminated and biased by placing all three jumpers in the UP or I/O position. All other devices on the daisy chain must have all three jumpers set to the DOWN or NO position. **Figure 6-2** shows the proper terminating jumper settings for the E2 and for all I/O boards.

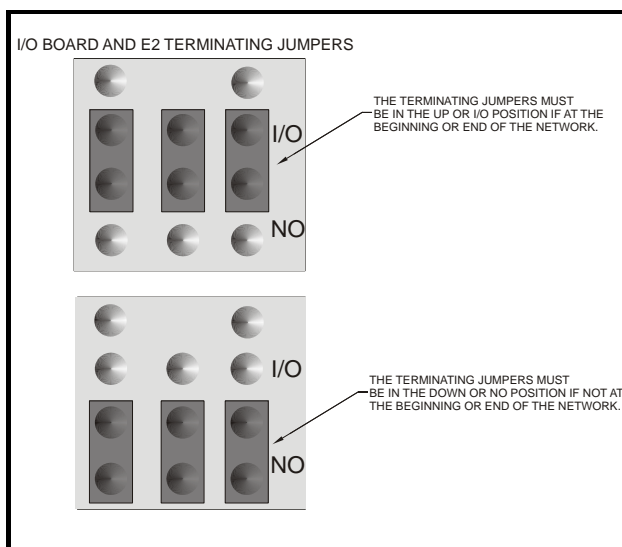

Figure 6-2 - I/O Network Termination Jumper Settings

6.1.9 Powering the I/O Boards

All models of E2-compatible I/O boards require 24VAC Class 2 input power. Some boards such as the 16AI, 8RO, 4AO, 8DO, MultiFlex ESR, and MultiFlex 16 use a *center-tapped* power source. All other models, such as the 8IO and MultiFlex Combination I/O boards, may use *non-center tapped* power sources.

Retail Solutions supplies a wide variety of 24VAC transformers with varying sizes and either with or without center taps. **Table 6-2** shows the transformer sizes and whether they are center-tapped or non-center-tapped. **Table 6-3** lists each board, the board's rating, and whether or not the board must use center-tapped power.

Xformer P/N	VA Rating	Input Voltage	Center Tap?
640-0041	50 VA	110 VAC	No
640-0042	50 VA	220 VAC	No
640-0056	56 VA	Multi-tap (120/208/240 VAC)	Yes

Table 6-2 - Transformers Compatible with I/O Network Boards

640-0050	75 VA	110 VAC	No
640-0045	75 VA	220 VAC	No
640-0080	80 VA	Multi-tap (120/208/240 VAC)	Yes

Table 6-2 - Transformers Compatible with I/O Network Boards

Unit	Amps	VA	VAC	Center-tapped?
16AI	0.25	5.0	24	Yes
8RO/SMT	0.75	15.0	24	Yes
4AO	0.5	10.0	24	Yes
8DO	1.5	18	24	Yes
8IO/ARTC	0.75	18	24	No
IRLDS	N/A	N/A	120/240	N/A
RLDS	N/A	N/A	120/240	N/A
MultiFlex ESR	3.3	80	24	Yes
MultiFlex 16	0.25	6	24	Yes
MultiFlex 88, 88AO, 168, and 168AO	0.75	15	24	No
MultiFlex 1616L, 1616LAO, 1616LDO	1.0	20	24	No

Table 6-3 - Device Power Requirements

To select a power transformer for a board or a series of boards:

1. Determine what the total VA is for the boards that will be powered by the transformer (see **Table 6-3**).

Example: Two MultiFlex 168AOs (15 VA each), and one 8DO (18 VA) boards are to be powered by one transformer. The total VA is:

$$(2 \times 15VA) + (1 \times 18VA) = 48VA$$

2. Use a transformer that has a power rating higher than the total calculated VA (see **Table 6-2**).

Example: For boards totalling 48VA, a 56VA transformer is sufficient, since 56VA is greater than 48VA.

I/O Board Transformers should be located within 10 feet of the board it is powering, preferably within the board enclosure.

6.1.9.1 Wiring Types

For powering I/O boards, use only the listed wire types from **Table 6-4**. Three-conductor non-shielded cables are the recommended wire for connecting between the center tapped transformer and the I/O boards. The third conductor should be connected to earth ground. If boards use a center-tapped transformer, also connect the center tap to the earth grounded third conductor.

Power Wiring Types	
14 AWG	Belden 9495
18 AWG	Belden 9493

Table 6-4 - Power Wiring Types

The wire length from the transformer and the number of boards connected to the same wire determines the type wire gauge used. In most cases, the distance between the I/O boards and the transformer that supplies power to them is not enough to be concerned with. But it is very important not exceed this maximum wire length or the boards will malfunction.

Use these formulas to determine if the wire gauge you are using fits within specification:

14 AWG:

$$\text{Feet} = 1920/VA$$

18 AWG:

$$\text{Feet} = 739/VA$$

(VA is the total VA rating of the I/O boards)

For example, if you had an 80 VA load:

$$14 \text{ AWG: } 24 \text{ ft}$$

$$18 \text{ AWG: } 9 \text{ ft (rounded down)}$$

Figure 6-3 - Power Wire Lengths

Sensors requiring 24VAC can be powered from the same transformer powering the input board as long as the resulting total load of both the input board(s) and the sensor(s) connected to the transformer does not exceed the transformer's VA rating. Consult **Section 6.1.9, Powering the I/O Boards**, and **Section 8.6.1, Powering Echelon Devices** for more information.

6.1.10 Board Installation

The following pages give step-by-step graphical instructions on all steps necessary to install each I/O Network device so that it is powered up and able to communicate with E2. If these devices have not yet been mounted, refer to **Section 3.2, *Mounting I/O Boards*** for mounting instructions for these devices.

6.2 IMC/Prodigy Rooftop Unit Controllers

All E2 Building Controller (BX) versions 2.21F01 and above may communicate with IMC/Prodigy rooftop units equipped with IMC/Prodigy control boards version M4-1 or higher. E2 controllers version 2.30F01 and above may use any of the RS485 I/O ports (COM2, COM4, or COM6) as a IMC/Prodigy communication port. Version 2.21F01 E2 units may only connect IMC/Prodigys to an RS485 Expansion Card. Connectivity to IMC/Prodigy is a licensed feature and must be purchased from Retail Solutions.

The IMC/Prodigy interface has its own technical bulletin explaining installation, network setup, and E2 configuration. Refer to *Technical Bulletin 026-4117*.

6.3 ECT MODBUS

E2 controllers version 2.30F01 or greater may select ECT MODBUS as a network type. The E2 communicates with MODBUS devices including but not limited to Control Link CD, Control Link RSC, and Control Link ACC.

The Control Link products have their own documents explaining device configuration, networking, and E2 setup:

- **026-4600** - Control Link RSC Installation Instructions
- **026-4601** - Control Link CD Installation Instructions
- **026-4704** - Control Link ACC Installation Instructions
- **026-4602** - Control Link ECT MODBUS Networking to E2s (covers MODBUS installation for all Control Link models)

6.3.1 Control Techniques Drive (VSD)

Using the MODBUS network type, E2 controllers can communicate with the Control Techniques variable-speed drive (VSD). There are three different VSD models the E2 communicates with: Commander SE, Commander SK,

and Unidrive SP drive types.

Note that all CT drives are 2 stop bits, with no parity. Since ECT MODBUS specifies 1 stop bit, CT drives will configure the General Services setting for stop bits and always communicate with the drives using 2 stop bits. The E2 calculates the difference and adjusts for the additional stop bit.

Configure the COM port the CT drive will connect to by pressing Alt + M to open the serial configuration manager. Set the COM port to **MODBUS** and the baud rate (match the baud rate on the CT drive). For more information on setting up serial ports, go to **Section 5, *Serial Configuration***.

The Control Techniques VSD has its own technical bulletin that explains interfacing with E2 (*P/N 026-4122*). The installation and operation manual explaining the VSD is maintained by Control Techniques. Contact your Control Techniques representative for a copy of this manual.

6.3.2 Copeland ISD Compressors

E2 controllers version 2.21F01 and above may communicate with Copeland ISD compressors using the ECT MODBUS network. E2 controllers version 2.30F01 and above may use any of the RS485 I/O ports (COM2, COM4, or COM6) as a Copeland ISD communication port. Version 2.21F01 E2 units may only connect Copeland ISD compressors to an RS485 Expansion Card.

The installation and operation manual explaining the Copeland ISD interface is maintained by Copeland. Contact your Copeland representative for a copy of this manual.

6.3.3 XR, XEV, and XEV22D Case Controllers

E2 controllers version 2.84 or greater communicate with the XR and XEV controller. The XR and XEV control compressor regulation, defrost, light, and evaporator fans in refrigeration systems on normal, low, or medium temperatures, control a wide variety of stepper electronic expansion valves and anti-sweat heaters (if present), and measure and regulate the superheat of the refrigerant in the system.

If the case controller is configured with a Real Time Clock (RTC), it can be programmed with up to 6 daily defrosts and an energy saving function. Without the RTC, the E2 can coordinate defrost cycles and the energy-saving function.

Several parameters of the Emerson controllers (such as inputs, outputs, setpoints, and alarms) can be configured directly in E2 and sent to the appropriate Emerson controller, depending on the controller model.

6.3.7 Discus

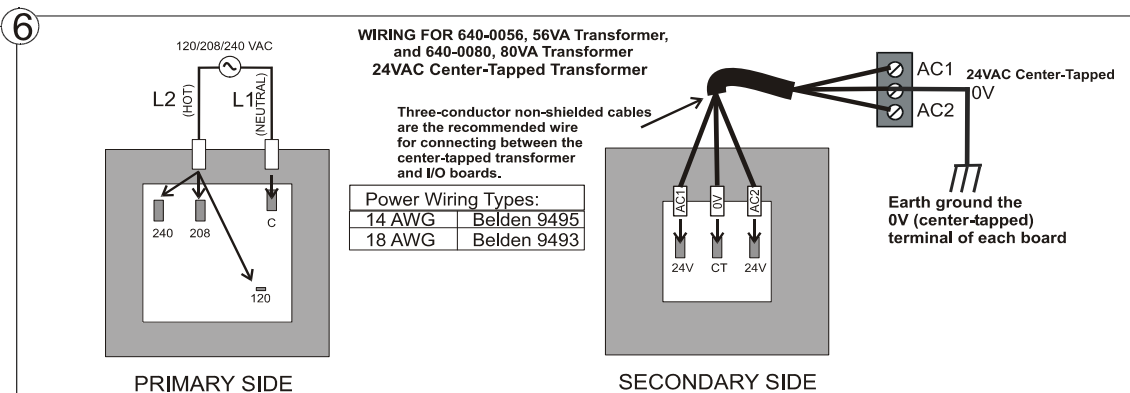
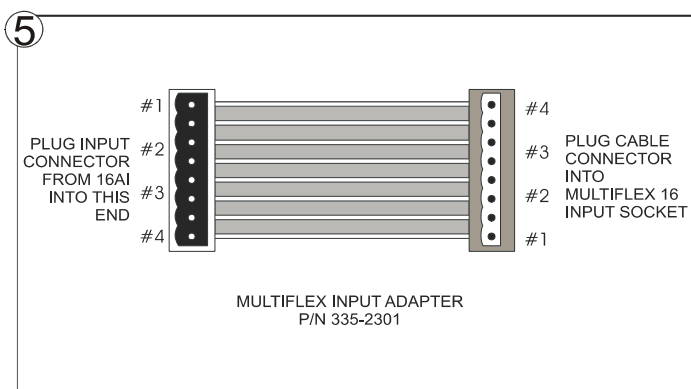
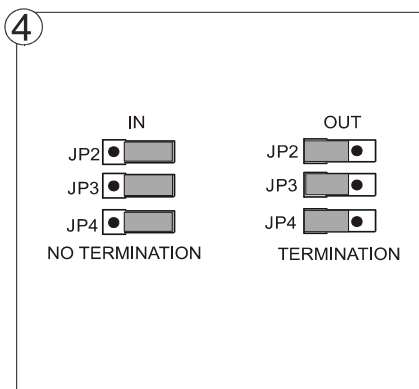
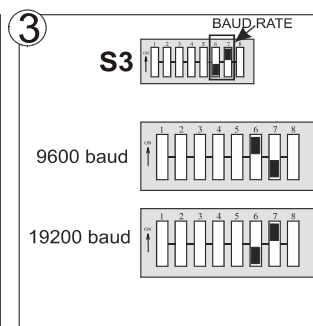
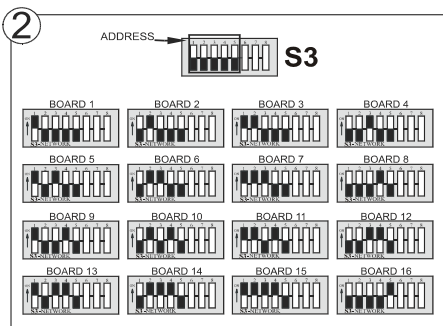
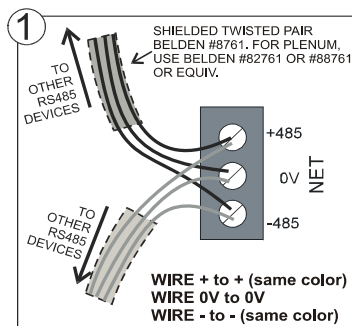
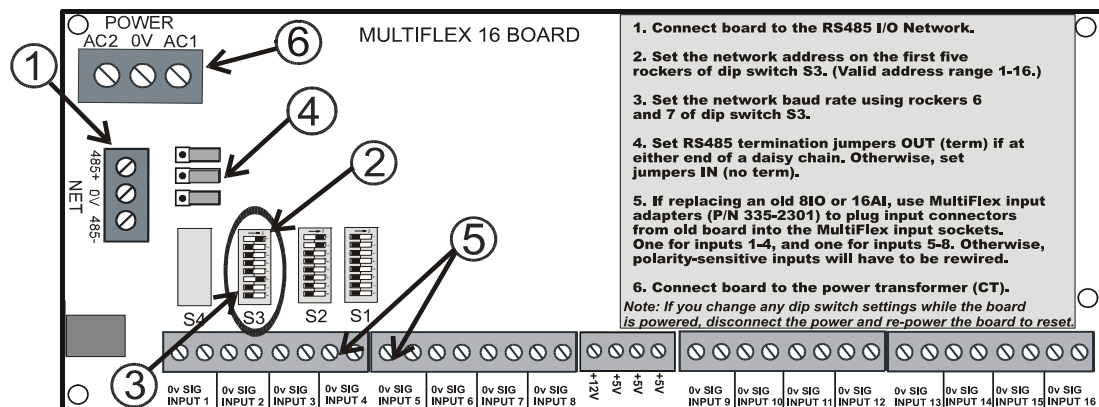

Figure 6-7 - Copeland Discus Compressor

The Discus application can monitor semi-hermetic compressors using the MODBUS network on E2 versions 3.01 and above. The E2 monitors and records semi-hermetic compressor information. The Discus application has extensive logging capabilities that record a compressor's Run History, Fault History, and Alarm Status.

The Copeland Discus is supported on E2 RX-300, CX-400 and above.

MULTIFLEX 16 INSTALLATION GUIDE



MULTIFLEX COMBINATION I/O BOARD INSTALLATION GUIDE

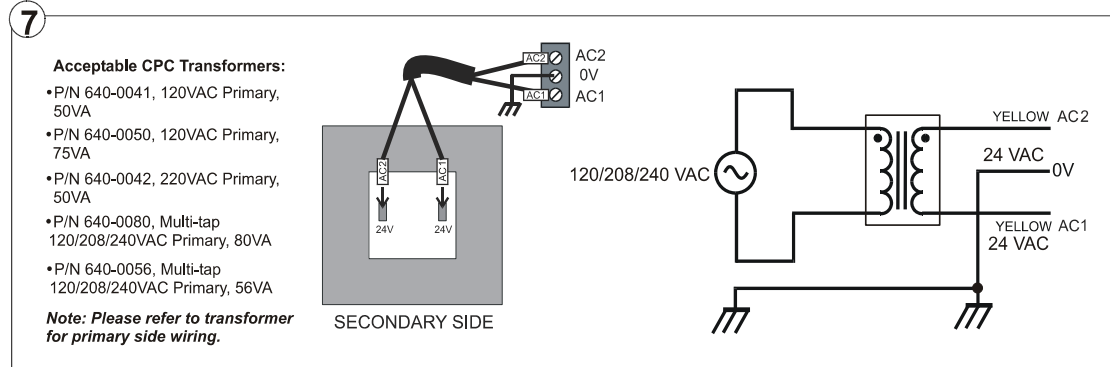
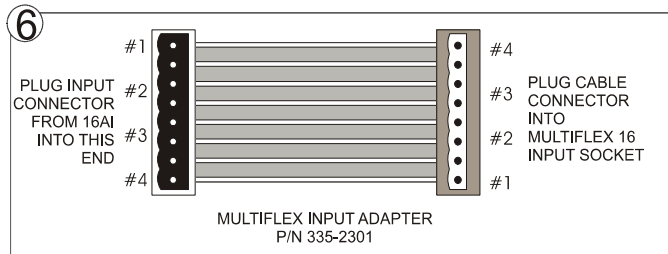
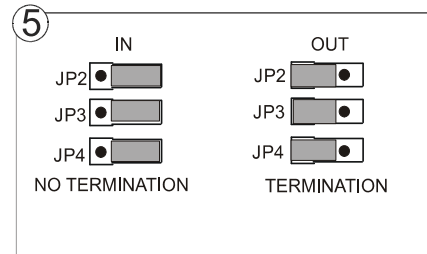
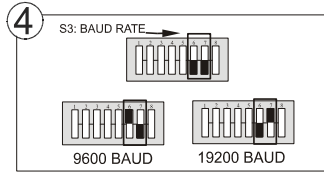
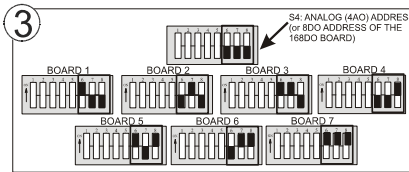
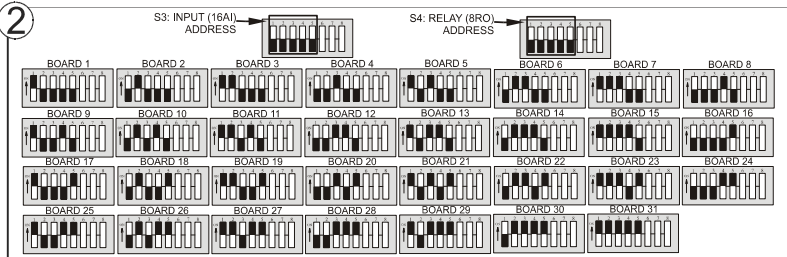
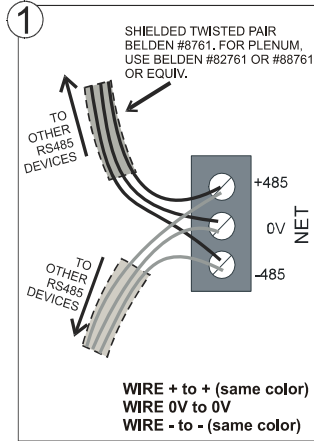
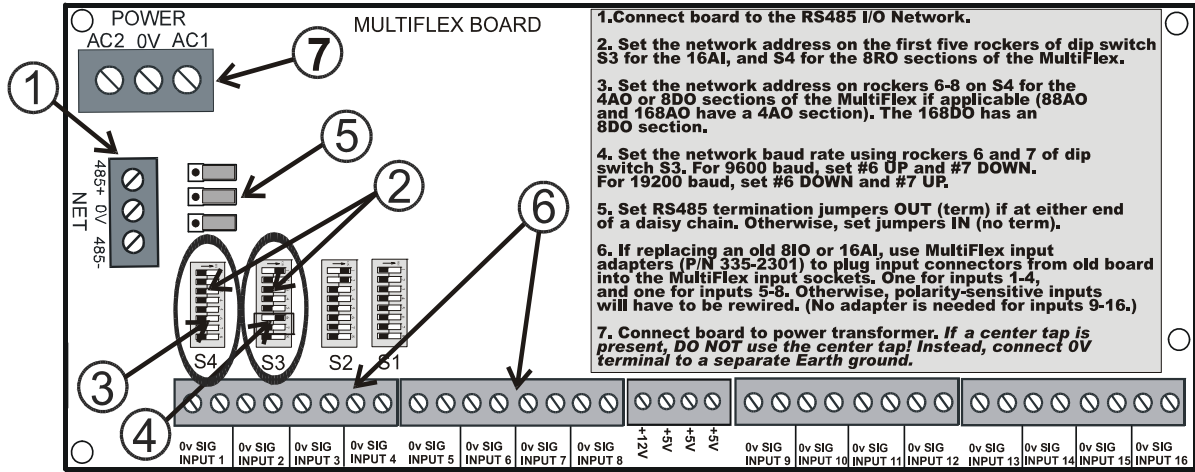

4AO INSTALLATION GUIDE

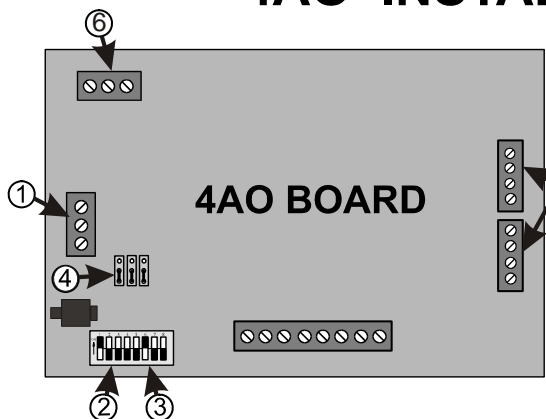

1. Connect the 4AO board to the RS485 I/O Network.
2. Set the network address on the first five rockers of dip switch S1.
3. Set the network baud rate using rockers 6 and 7 of dip switch S1.
4. Set RS485 termination jumpers UP (terminated) if at either end of a daisy chain. Otherwise, set jumpers DOWN (not terminated).
5. Optionally, connect the 4-20mA outputs in either a 2-wire or 4-wire hookup as illustrated in Step 5, or if a 4-20mA is not used, it may be left unconnected.
6. Connect board to the 24VAC *center-tapped* secondary of the power transformer.

CAUTION: If you change any dip switch settings while the board is powered, disconnect the power and re-power the board to reset.

NOTE: The voltage divide function capability on the previous model (P/N 810-3030) 4AO board is no longer supported. This can now be accomplished by using two external 15-K resistors. If used with E2,

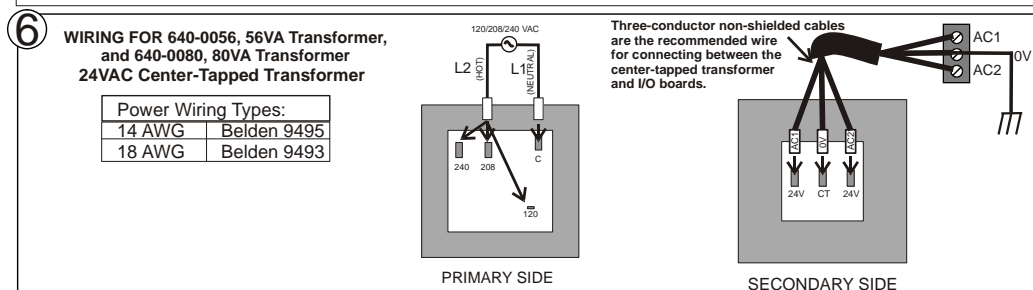
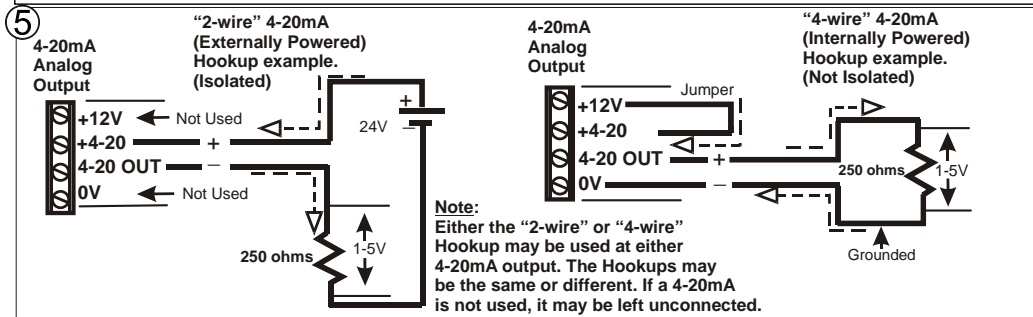
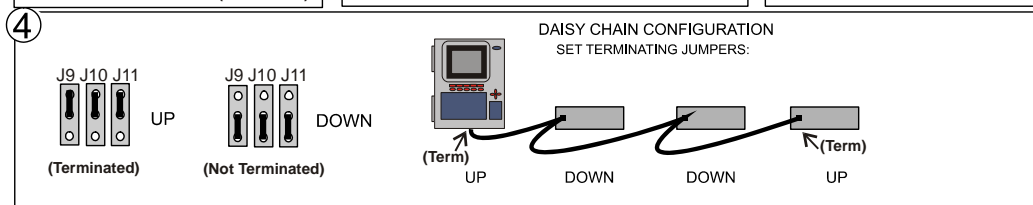
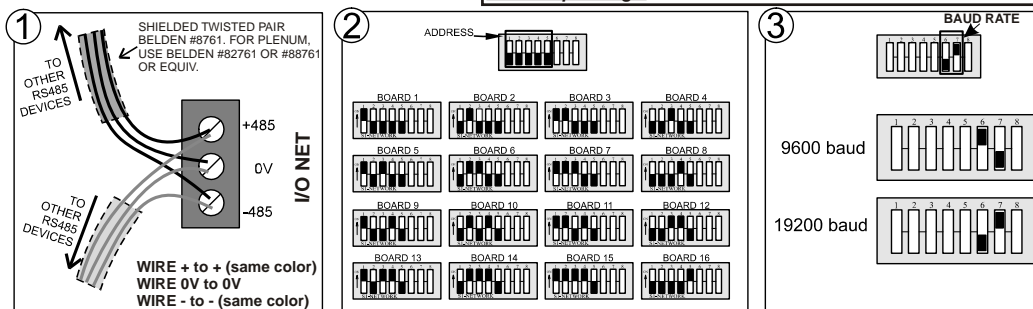
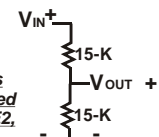

4AO INSTALLATION GUIDE

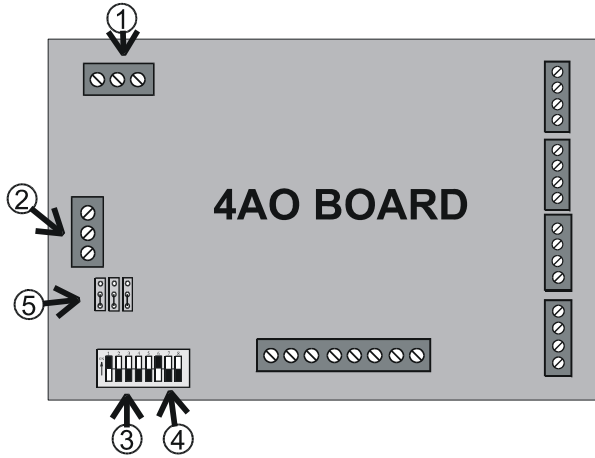

1. Connect board to power transformer.
2. Connect 4AO to the RS485 I/O Network.
3. Set the network address on the first five rockers of dip switch S1.
4. Set the network baud rate using rockers 6 and 7 of dip switch S1.
5. Set RS485 termination jumpers UP or DOWN at either end of a daisy chain. Otherwise, set jumpers DOWN.
6. **Note: if you change any dip switch settings while the board is powered, disconnect the power and re-power the board to reset.**

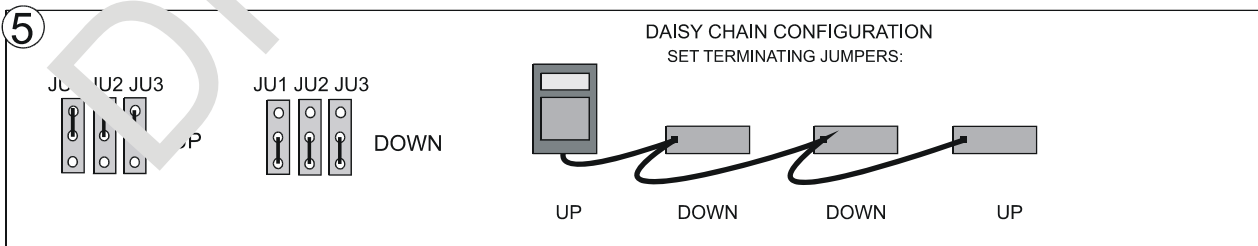
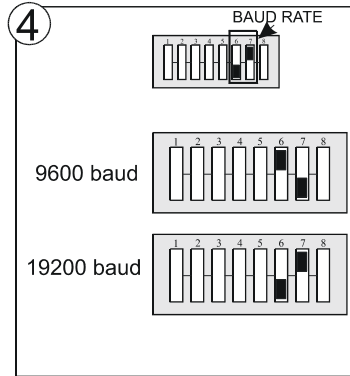
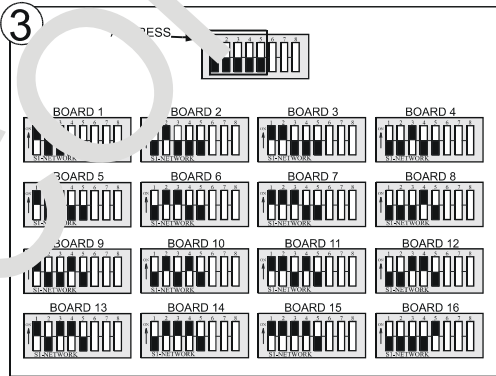
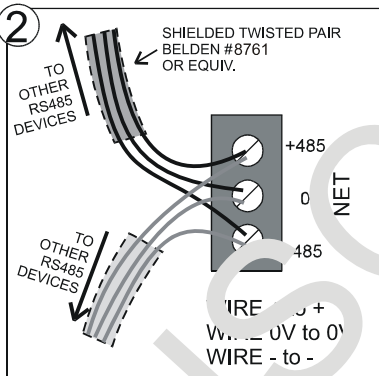
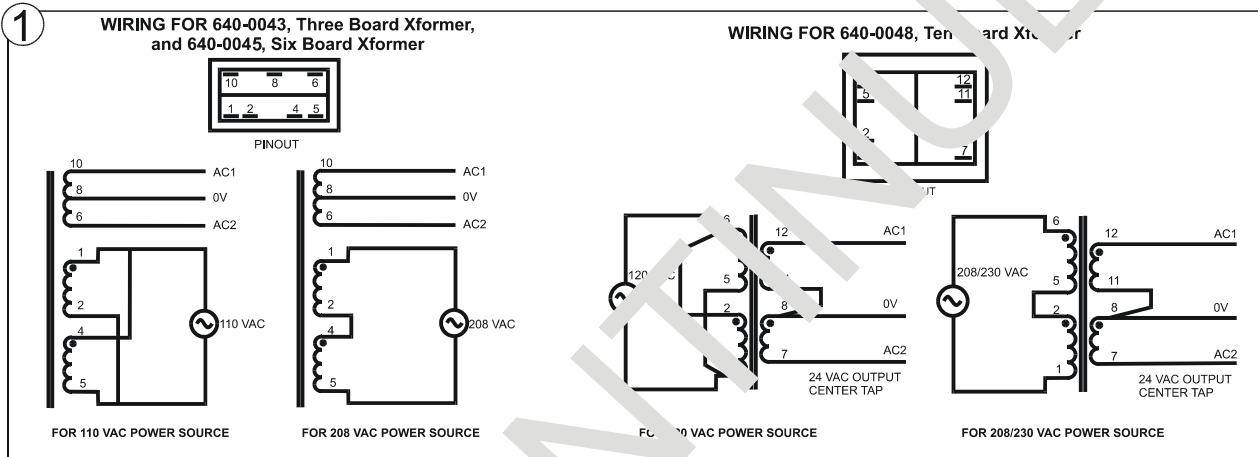

8IO INSTALLATION GUIDE

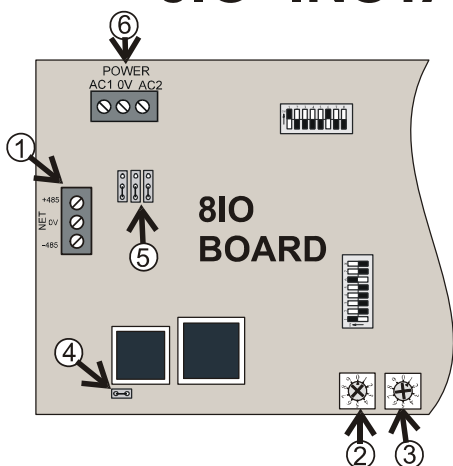

1. Connect 8IO to the RS485 I/O Network.
2. The output section of this board must be given a separate network ID number as if it were an 8RO . Set the network ID number using rotary switch S1.
3. The input section of this board must be given a separate network ID number as if it were a 16AI. Set the network ID number using rotary switch S2.
4. Set the jumper JU4 to enable or disable the analog outputs.
5. Set RS485 termination jumpers UP if at either end of a daisy chain. Otherwise, set jumpers DOWN.
6. Connect board to power transformer. **DO NOT USE THE CENTER TAP!** Connect 0V terminal to a separate Earth ground.

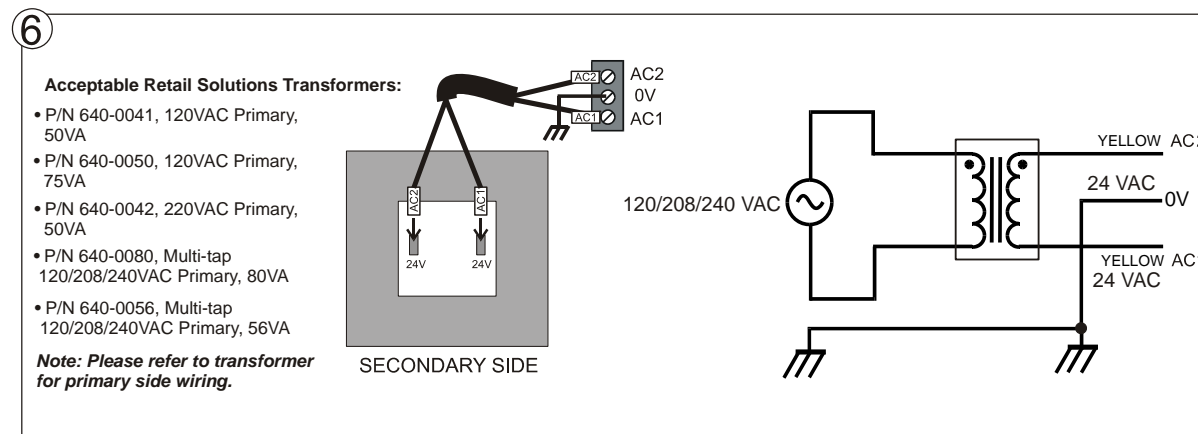
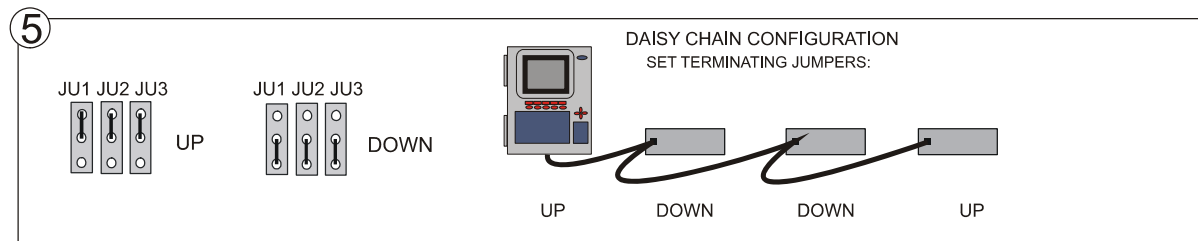
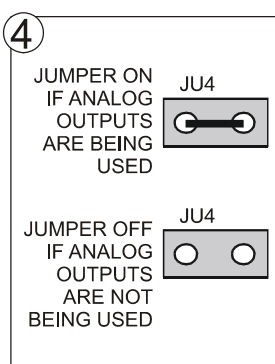
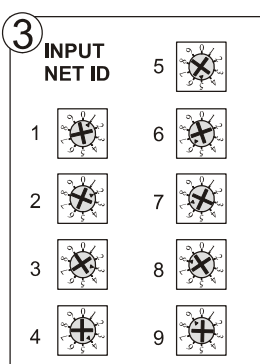
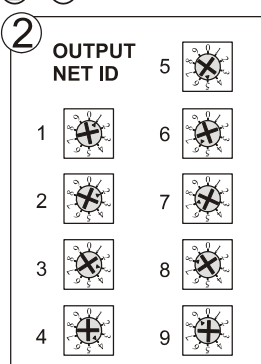
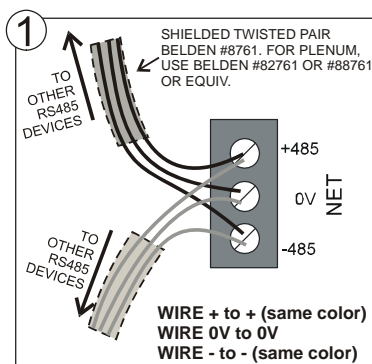

16AI INSTALLATION GUIDE

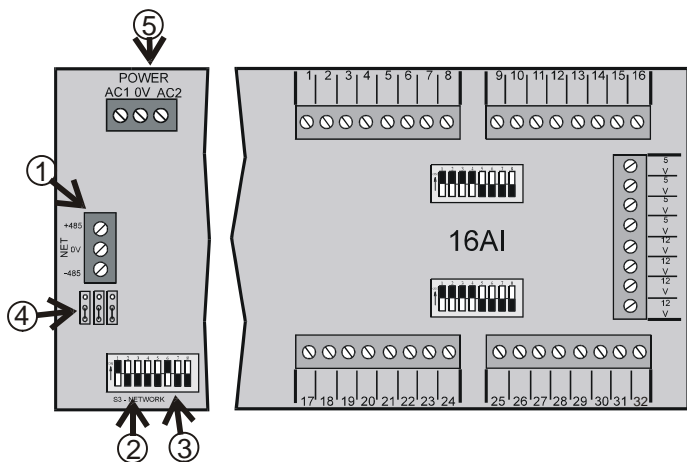

1. Connect 16A1 to the RS485 I/O Network.
2. Set the network address on the first five rockers of dip switch S3.
3. Set the network baud rate using rockers 6 and 7 of dip switch S3.
4. Set RS485 termination jumpers UP (term) if at either end of a daisy chain. Otherwise, set jumpers DOWN (not term).
5. Connect board to the 24VAC *center-tapped* secondary of the power transformer.

Note: If you change any dip switch settings while the board is powered, disconnect the power and re-power the board to reset.

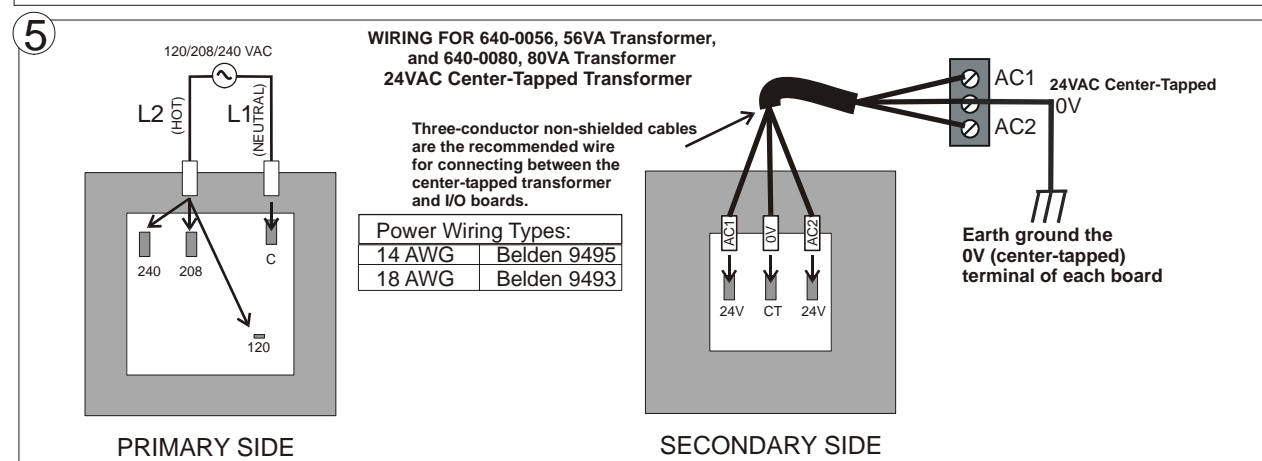
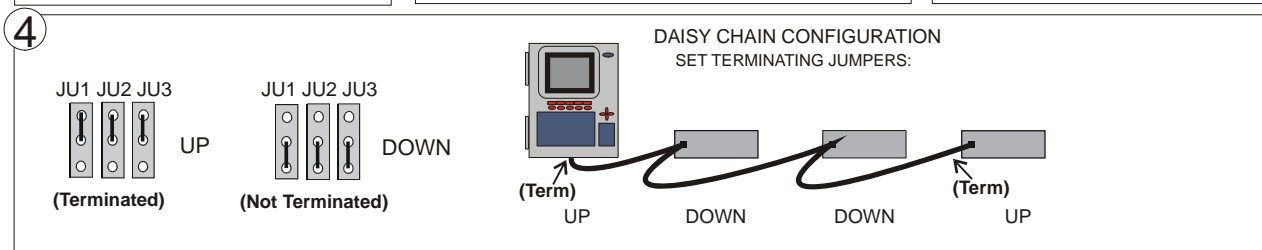
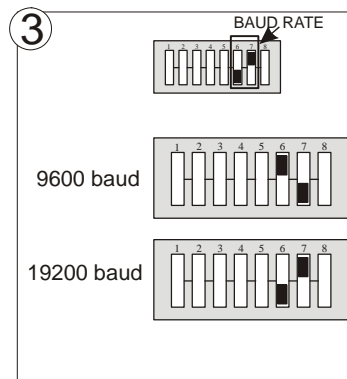
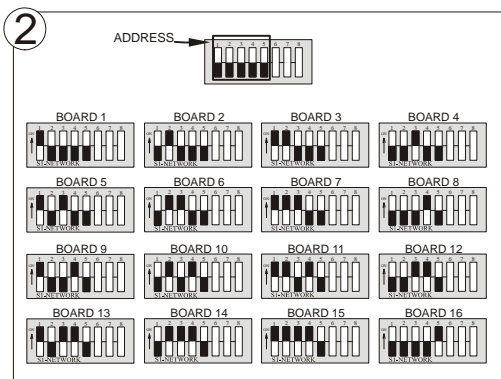
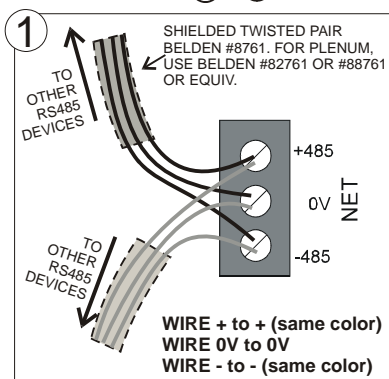

MultiFlex ESR INSTALLATION GUIDE

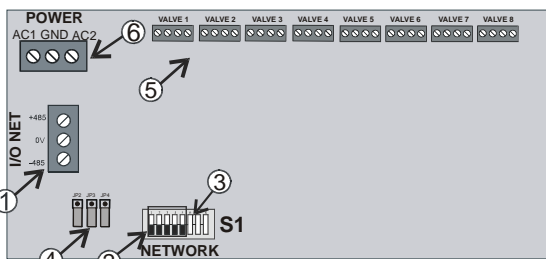

1. Connect the MultiFlex ESR to the I/O Network.
2. Set the network address on the first five rockers of the dip switch (labeled S1) on the MultiFlex ESR board.
3. Set the network baud rate using rockers 6 and 7.
4. Set the termination jumpers UP (terminated) if at either end of a daisy chain. Otherwise, set jumpers DOWN (no termination).
5. Wire each stepper valve by connecting the stepper valve harness to one of the eight connectors along the top of the board.
6. Connect the MultiFlex ESR to a Class 2, 80VA 24VAC *center-tapped* power transformer. (One MultiFlex ESR board per transformer.) For more information on transformer wiring, refer to the MultiFlex ESR manual (P/N 026-1720).

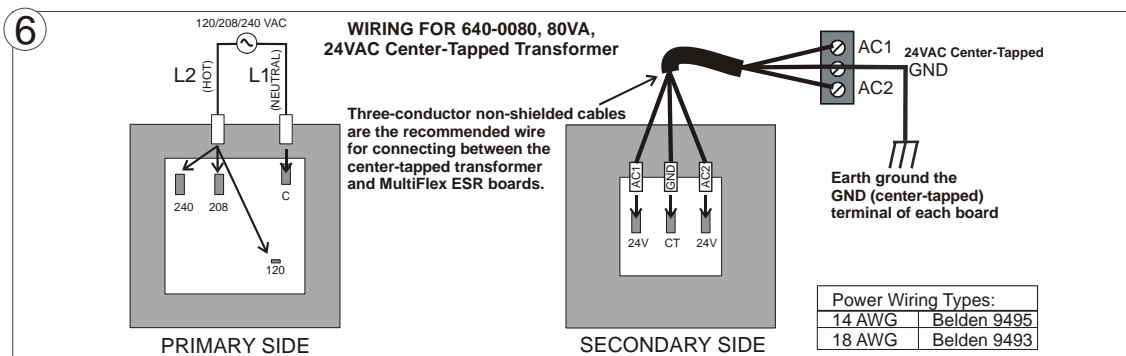
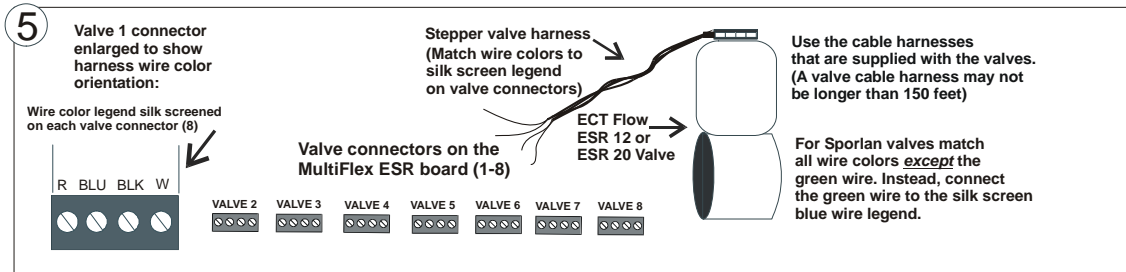
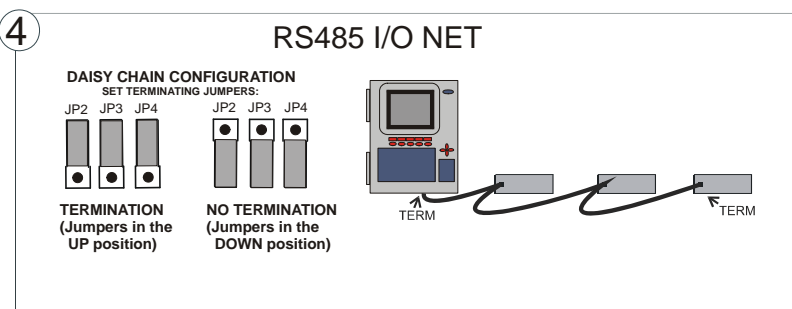
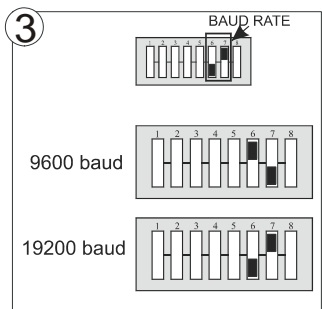
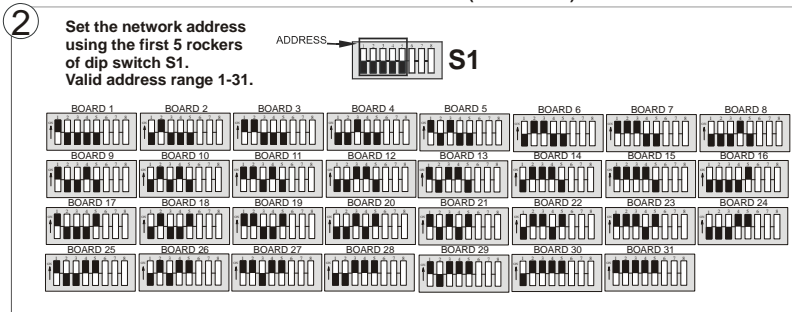
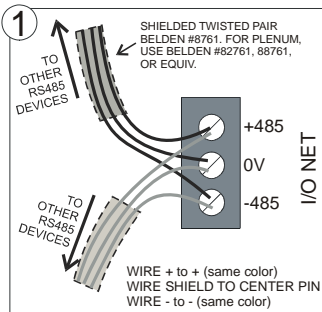

XEV22D TO E2 INSTALLATION GUIDE

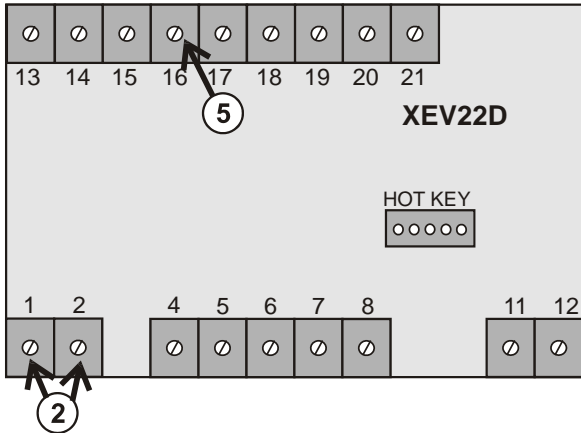

1. Connect the MODBUS Network to the RS-485 Connector on the E2 PIB board (Belden 8641 recommended).
2. Note to wire the RS-485 +/- polarity at the E2 in the reverse of the XEV22D device.
3. Position the three termination jumpers to the UP (terminated) position to provide RS-485 termination at the E2.
4. Do not connect the shield of the MODBUS network to the E2 PIB center terminal. Instead, use a 100 ohm ½ watt resistor to connect the MODBUS cable shield to earth ground.
5. At the XEV22 device, wire the MODBUS cable to the RS-485 +/- terminals and connect the MODBUS shield to the pin 16 terminal.
6. Terminate the end of the MODBUS network at the last device on the daisy chain with the MODBUS termination block (P/N 535-2711), or by connecting a 150 ohm resistor between the MODBUS +/- terminals.

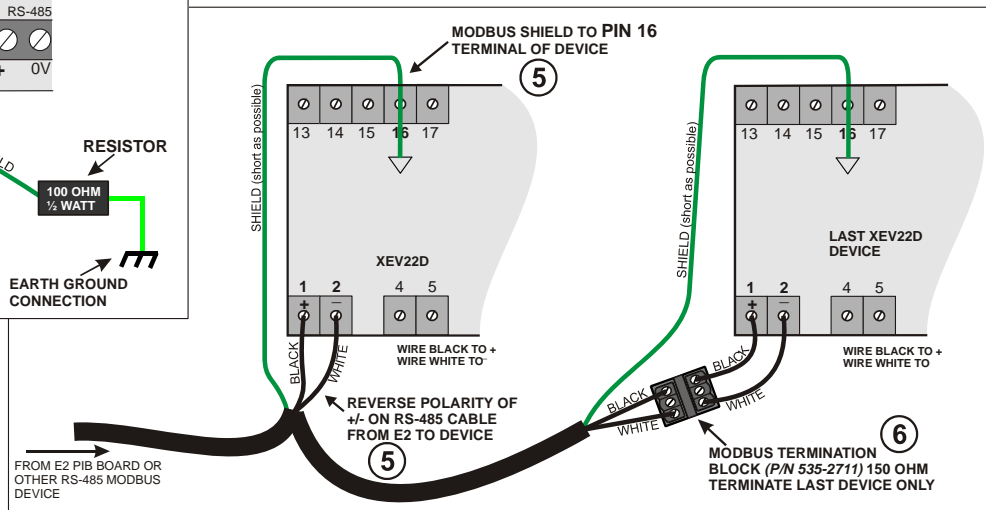
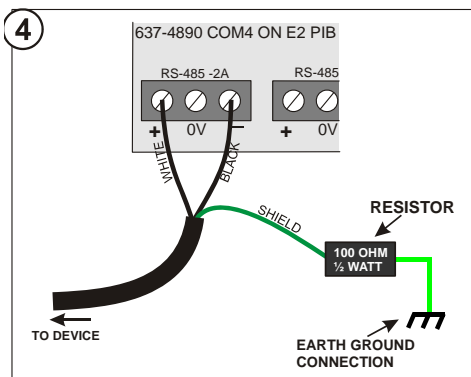
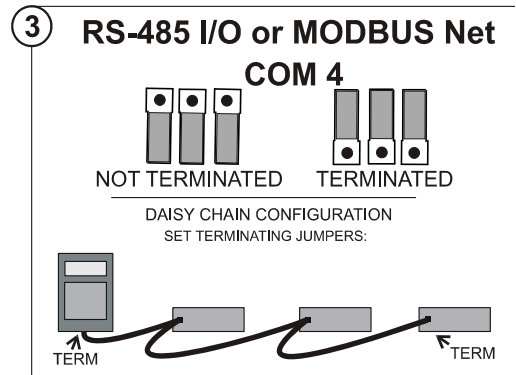
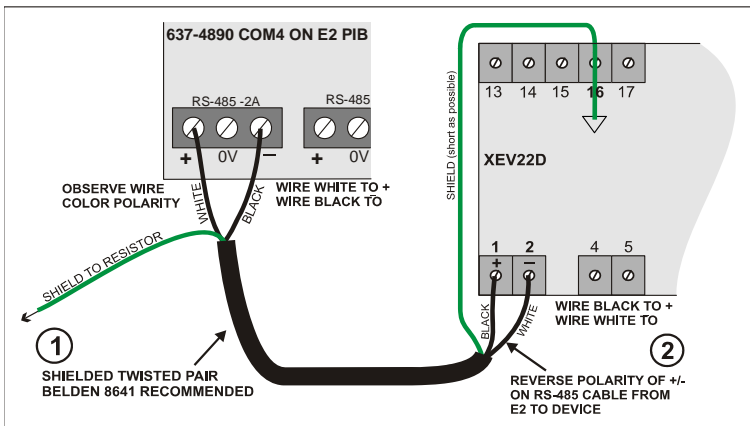

XR35CX, XR75CX TO E2 INSTALLATION GUIDE

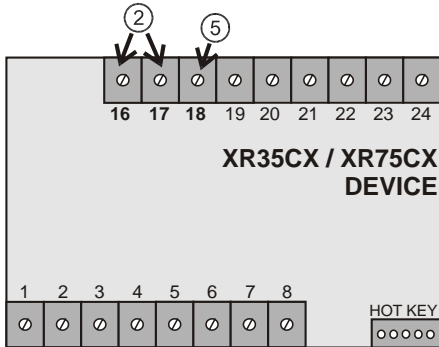

1. Connect the MODBUS Network to the RS-485 Connector on the E2 PIB board (Belden 8641 recommended).
2. Note to wire the RS-485 +/- polarity at the E2 in the reverse of the XR35CX or XR75CX device.
3. Position the three termination jumpers to the UP (terminated) position to provide RS-485 termination at the E2.
4. Do not connect the shield of the MODBUS network to the E2 PIB center terminal. Instead, use a 100 ohm ½ watt resistor to connect the MODBUS cable shield to earth ground.
5. At each device, wire the MODBUS cable to the RS-485 +/- terminals and connect the MODBUS shield to the pin 18 terminal.
6. Terminate the end of the MODBUS network at the last device on the daisy chain with the MODBUS termination block (P/N 535-2711), or by connecting a 150 ohm resistor between the MODBUS +/- terminals.

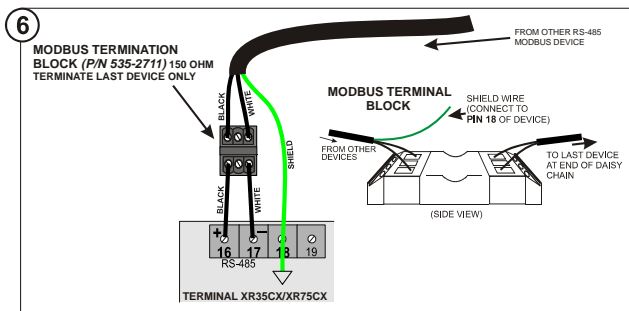
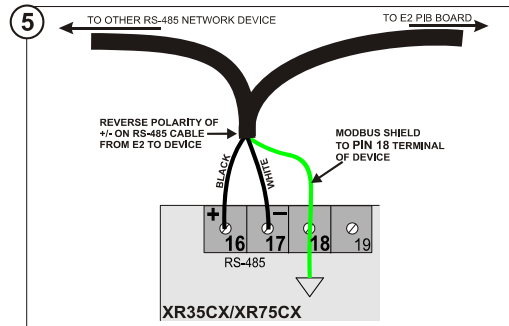
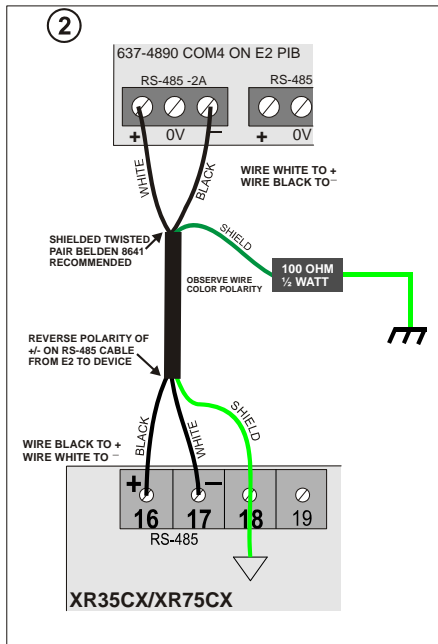
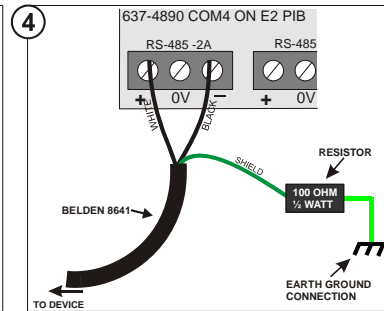
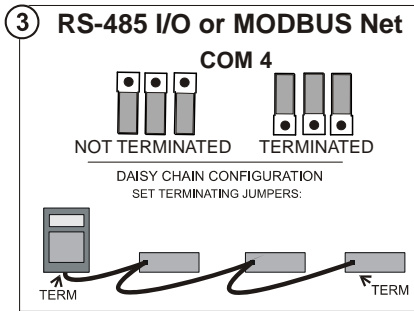
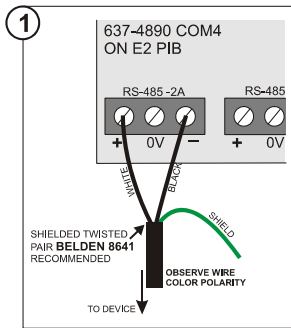

7 E2 Ethernet Peer Communications

Communication between E2 controller version 2.10 or greater may now be implemented through an Ethernet network using TCP/IP protocol. To utilize peer connections over Ethernet, the following tasks must be performed:

- Upgrade the E2 controller firmware to version 2.10 or greater.
- Install an industry-standard Ethernet switch(es) or hub(s) in an area or areas nearby the E2 controllers.
- Install Ethernet straight-through cabling at the site from each E2 to the switch or hub. Installation of RJ-45 connectors may be necessary to achieve this goal. The recommended cabling is CAT 5.

7.1 Ethernet IP Configurations

If using an open network configuration (see **Section 7.4.2, Open Network Layout**), contact your IT Network Administrator for all IP configuration information (IP Address, Subnet Mask, Primary and Default Gateway settings).

7.2 Hardware Specifications

Standard industry-accepted practices for wiring of Ethernet networks are expected. E2 controllers use a star topology, identical to PC deployment. This includes a unique “point-to-point” run from a switch or hub to the controller (see **Table 7-1** for hub part numbers for ordering). This is done with Category5 (or better) cable. Maximum distance for a run of 10BaseT is 328 feet (100 meters) (11.5 dB loss max).

- The maximum number of controllers allowed on an IP subnet is 20. All E2 controllers that must communicate with each other must be on the same subnet.
- Recommended Ethernet cabling is CAT 5 (straight-through cable).
- 328 feet (100 meters) is the maximum distance allowed between devices before a switch or hub must be added.

7.2.1 Components

Equipment Type	Specifications
Ethernet Five- or Nine-port Switch (may require an additional power supply)	<ul style="list-style-type: none"> * Industrial grade * Operating/storage temp range: -40°F to 185°F * Vibration: IEC68-2-6 * RH: 5 to 95% * UL 508A, CE approved * Supports 10Base-T crossover cable * Supports all IEEE 802.3 protocol * Supports Auto Crossover MDI/MDI-X * Screw-terminal power connectors
Ethernet Surge and Lightning Protector (recommended)	<ul style="list-style-type: none"> * Industrial grade * Surge capacity: 1 kA / line * Operating temp range: -40°F to 185°F * Max frequency: 155 MHz * Clamp and rated: 10V and 5V
10-Base-T/100-Base-TX Hub	Room Temperature (0 to 50 C) <i>P/N 570-0100</i>
10-Base-T/100-Base-TX Hub	Extended Temperature (-40 to 65 C) <i>P/N 570-0200</i>

Table 7-1 - Equipment for E2 Ethernet Peer Communications



NOTE: An external power supply may be needed.

7.3 Software Specifications

TCP/IP

E2 controller versions 2.10 and later communicate between controllers using the TCP/IP protocol. TCP Port 7238 is the default for connections established between the controllers. All peer communications occur over this port.

7.4 Ethernet Network Layouts

The two types of network options for E2 controllers using Ethernet communications are:

1. “Closed Network” - E2 devices are *not connected* to a store’s LAN. (The only devices on the network are the E2 controllers themselves.) This network type is used if there is no need to integrate the network into the company’s intranet.
2. “Open Network” - E2 devices are *connected* to the store’s LAN. (Devices on the network include E2s and other Ethernet-TCP/IP devices.) This network type is used if the network will be connected to the store’s LAN.



NOTE: Contact your IT Network Administrator for setup parameters for both closed and open networks.

The E2 peer Ethernet network facilitates communications between E2 controllers. These include at least the following:

- Routing of messages between external entities such as UltraSite, InSite, Site Manager, and non-gateway E2 controllers.
- Distribution of global data and other network variables such as system time, controller identification, etc.
- Communication between E2 controller applications such as Remote Login and Remote File Services.



NOTE: The gateway E2 is the E2 controller at a remote site to which UltraSite directly connects. It is through this E2 that UltraSite communicates with the other controllers (defined as the “non-gateway” E2s and external entities such as UltraSite, InSite, Site Manager etc.).

7.4.1 Closed Network Layout

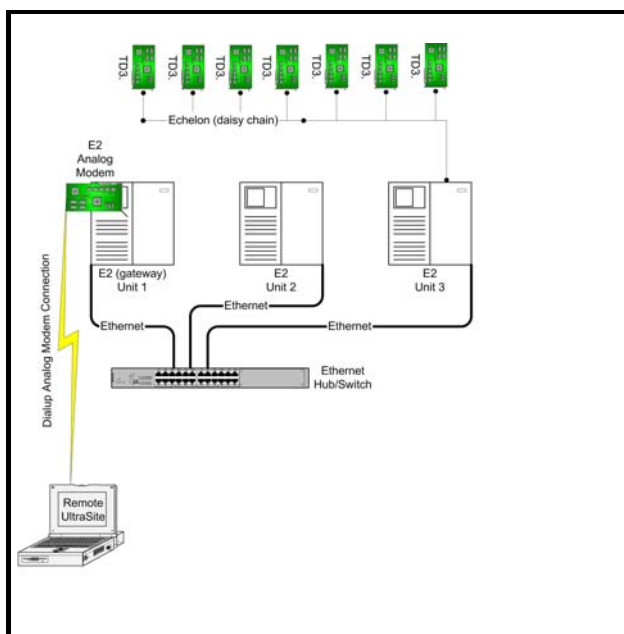

Figure 7-1 - Closed Network Layout

7.4.2 Open Network Layout

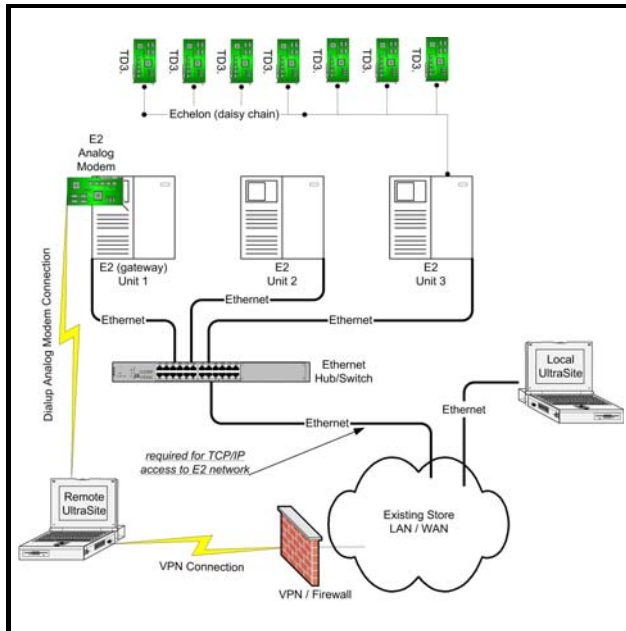
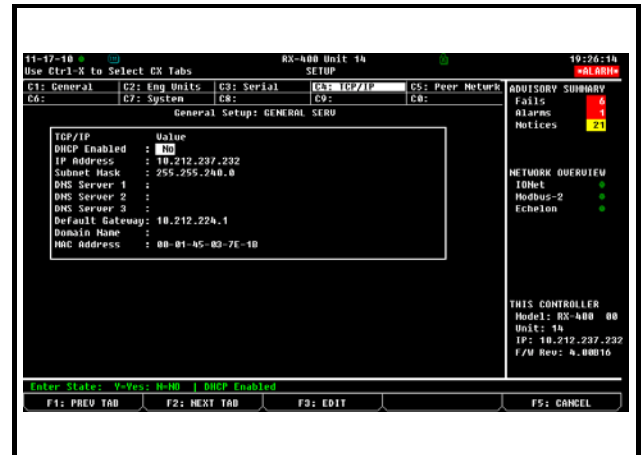

Figure 7-2 - Open Network Layout

7.5 Software Setup

1. Log on to the E2 controller
2. Navigate to the **TCP/IP** setup screen (**Alt + T**)

NOTE: DHCP does not have to be enabled if you have the IP Address, Subnet Mask, and Primary Gateway settings. (Contact your IT Network Administrator for all IP configuration information.) If you do not have the IP configuration settings, and there is a DHCP server on the network, set DHCP Enabled to Yes and it will retrieve the information from the server and populate those fields. E2 controllers must all have the same Ethernet Subnet in order to communicate box-to-box.



TCP/IP Setup Screen

3. Tab over to the **Peer Netwrk** tab:

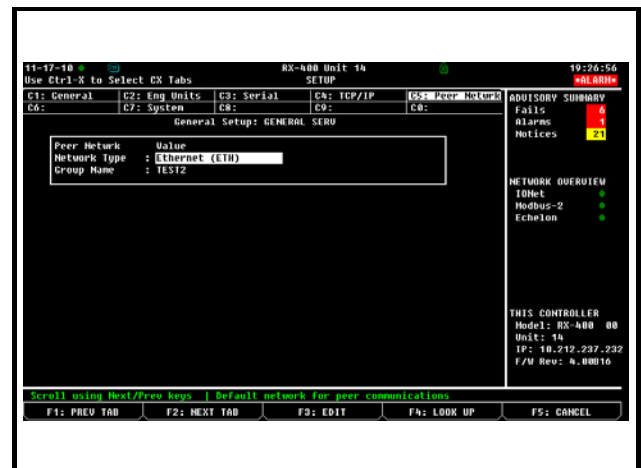

Peer Network Tab - Set Network Type

4. Change **Network Type** to: **Ethernet (ETH)** and press Enter. The **Group Name** field is now visible.

NOTE: If unsure of any tab settings, it is recommended that the default settings be used.

5. Once the Ethernet network type is enabled, enter a unique site name in the **Group Name** field.

NOTE: The site name is the unique identifier for the site that will allow the controllers within the same group to share data.

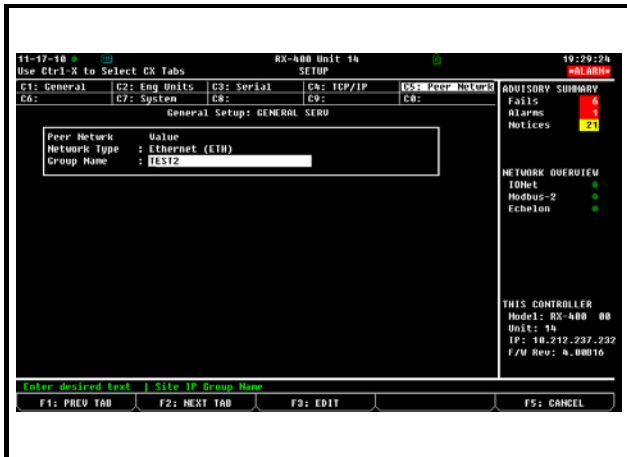

Peer Network Tab - Set Group Name

All controllers that you would like to appear in this group must all have the same group name and must be using the same network type.

7.6 Troubleshooting

Network troubleshooting is outside the scope of this section (**Section 7, E2 Ethernet Peer Communications**). Consult your IT Network Administrator for any additional information needed.

8 Echelon Network and Hardware Setup

8.1 Overview

Echelon is an optional, two-conductor network that interconnects E2s and other associated devices, such as CC-100 case controllers, TD3 temperature displays, and ESR8 evaporator stepper regulator boards. All Echelon devices are wired together using the daisy-chain method of network structuring. If an Echelon network-enabled E2 is required, it must be specifically ordered from Retail Solutions as an Echelon-enabled E2, and equipped with an Echelon plug-in card. See **Section 4.3.1, Echelon Card Plug-In (P/N 537-4860) with mounting screw (P/N 101-4201)**.

8.2 Wiring Type

Retail Solutions specifies one type of cable for Echelon Network wiring. This cable type's properties are listed in **Table 8-1**.

Cable Type	Level 4, twisted pair, stranded, shielded
Wire Diam./AWG	0.65mm/22AWG
Loop Resistance	106(ohms/km)
Capacitance	49(nF/km)

Table 8-1 - Echelon Network Cable Specifications

Cable Type	Retail Solutions Part Number
1 pair, non-plenum	135-2300
1 pair, plenum	135-2301

Table 8-2 - Recommended Wiring

8.3 Echelon Network Structuring (Daisy-Chains)

Echelon devices are networked together into configurations called **segments**. A segment is a group of up to 64 Echelon devices that are connected together on an unbroken series of wires.

The recommended way of constructing an Echelon Network is called **daisy-chaining**. In the daisy-chain network configuration, devices are arranged by **subnets**, which consist of one E2 and all Echelon devices associated with the E2.

First, all devices in a subnet are connected in an unbroken chain without branches or “star configurations” (see **Figure 8-1**). Then, if more than one E2 is present on-site, all chains are connected so that the entire network forms a

large unbroken chain, called a daisy chain (see **Figure 8-2**). This allows for all devices in the Echelon Network to be hard wired together for trouble free communication.

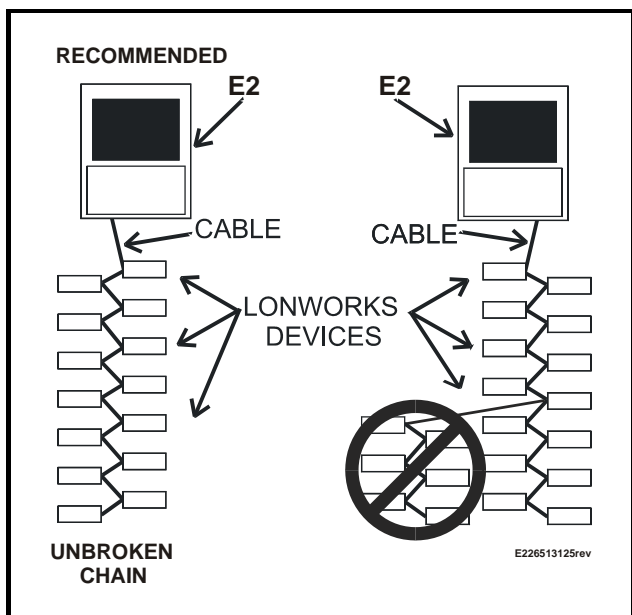

Figure 8-1 - Echelon Wiring - Subnets

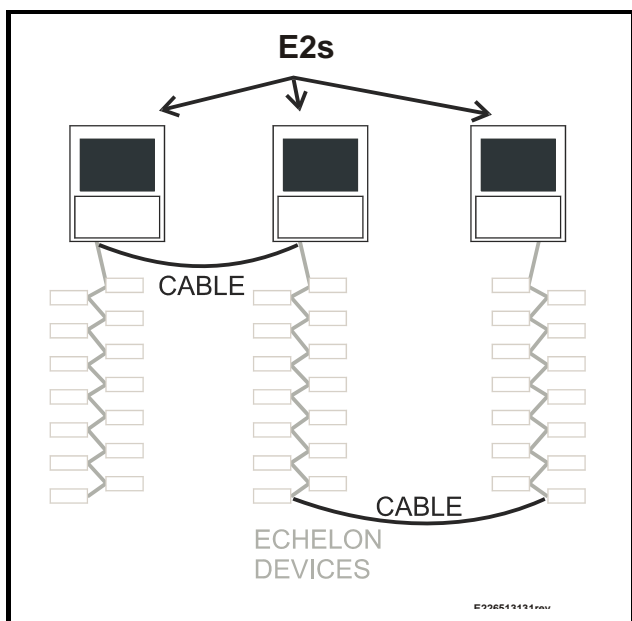

Figure 8-2 - Echelon Wiring, pt. 2

8.3.1 Maximum Number of Echelon Devices

A daisy-chained segment may contain no more than 63 total Echelon devices (also called "nodes"). If there are 64 or more Echelon devices at your site, an Echelon-compatible router (P/N 572-4200) will be required. A router placed on the Echelon Network allows you to add another 63-node daisy-chain network. For larger installations,

multiple routers can be used to extend the network indefinitely.

More information about routers and how they are used in a daisy-chain Echelon Network can be found in the *Router and Repeater Installation Guide (P/N 026-1605)*.

8.4 Device Termination

In a daisy-chain configuration, both ends of the network segment must be terminated. Terminate the E2 by setting jumper J2 to the UP position, as shown in **Figure 8-3**. Other devices on the Echelon Network are terminated either by jumpers on the control board or by connecting a 102-ohm "terminator block" at the end of the network segment (see **Section 8.4.1, Using a Termination Block (P/N 535-2715) to Terminate a Daisy Chain**). Refer to the installation guide references at the end of this section for specific device termination instructions.

All other E2s and Echelon devices that aren't at the end of a daisy-chained network segment must be unterminated.

If a router or repeater is being used in a network, termination becomes more complicated, because routers and repeaters join multiple daisy-chain segments together. Refer to the *Router and Repeater Installation Guide (P/N 026-1605)*, for specific termination instructions.

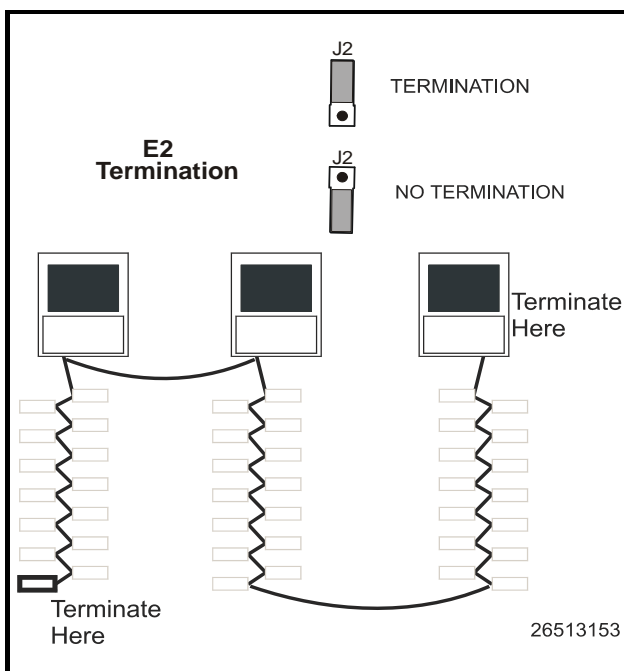

Figure 8-3 - E2 Termination - Daisy Chain

8.4.1 Using a Termination Block (P/N 535-2715) to Terminate a Daisy Chain

Some Echelon Network devices, notably TD3s, have no on-board means of terminating. For some other devices, it is inconvenient to use the jumpers supplied for termination (the CC-100/CS-100 case controllers, for example, require the enclosure to be removed to set the jumper).

To remedy these problems, Retail Solutions supplies termination blocks that can be wired to the end of an Echelon cable segment. This termination block uses the same three-pin connector as all other Echelon devices. Wire the two signal wires to the outside terminals, and connect the shield to the middle terminal (see *Figure 8-4*).

NOTE: The recommended termination procedure for all Echelon devices is the termination block.

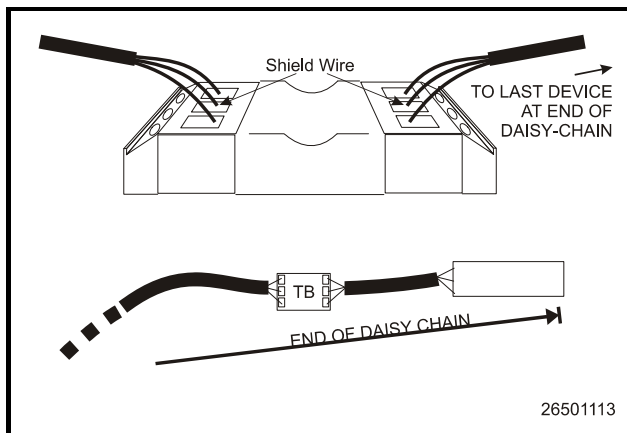

Figure 8-4 - Placement and Wiring of the Termination Block

8.5 Wire Restrictions

Maximum Total Segment Length

The total amount of wire used to connect all E2s and associated controllers in a single segment (not including devices on the other side of routers) cannot be longer than 4592 feet (1400 meters). If the total length of cable used is longer than 4592 feet, a repeater or router will be required.

Routers act as communication gateways that reduce the amount of network traffic. They are used when networks exceed their 63-node limit. Adding a router allows you to add another daisy-chain segment of 4592 feet with

a maximum of 63 more nodes.

Repeaters boost signal strength and are only used in instances where a segment of 63 nodes or less uses more than 4592 feet of Echelon cable.

Refer to the *Router and Repeater Installation Guide (P/N 026-1605)*, for information about router and repeater placement.

8.6 Installing Echelon Devices

The E2 control system has several types of peripheral control boards that communicate using the Echelon Network: the 16A1e analog input board, the 8ROe relay output board, the CC-100/CS-100 series of case control and case circuit control boards, and the ESR8 board.

8.6.1 Powering Echelon Devices

CAUTION: Do not power Echelon devices with the same 56VA and 80VA transformers used to power the I/O Network. Echelon devices require Class 2 power to operate, which is not supplied by the I/O board transformers.

All Echelon devices require 24VAC Class 2 power. Retail Solutions specs several sizes of transformers to accommodate the full range of Retail Solutions' Echelon-compatible products. *Table 8-3* lists each transformer's part number and rating.

Xformer P/N	VA Rating	Input Voltage
640-0039	10 VA	110 VAC
640-0041	50 VA	110 VAC
640-0042	50 VA	220 VAC
640-0050	75 VA	110 VAC
640-0045	75 VA	220 VAC

Table 8-3 - Class 2 Transformers for Echelon Devices

To select a power transformer for one or more Echelon devices:

1. Determine what the total VA is for the boards and controllers that will be powered by the transformer (see *Table 8-4*).

Example: Two TD3 boards (4 VA each), and one E2 (40 VA) board are to be powered by one transformer. The total VA is:

$$(2 \times 4VA) + (1 \times 40VA) = 48VA$$

2. Use a transformer that has a power rating equal to or higher than the total calculated VA (see **Table 8-3**).

Example: Boards totaling 48VA can be connected to either a 50VA or 75VA transformer.

Unit	amps	VA	VAC	Center tapped?
E2	1.66	40	24	No
ESR8	2.4	75	24	No
TD3	0.11	4	24	No
CC-100/ CS-100	Power supplied by Power Module			

Table 8-4 - Device Power Requirements

Refer to the installation guides on the next few pages for instructions on how to install these boards on the Echelon Network.

8.7 LEDs

The Echelon Board LEDs can be used to determine the status of normal operating parameters for the board.

Echelon Board	Status
Red (D1) (Reset)	ON: The Echelon port is being held in reset or if momentary it means the board has gone through reset
Red (Service)	<p>During normal operation this LED should be off. If the Service Pin is pressed, this LED will come on.</p> <p>If the LED is blinking, the node does not have its Subnet/ Node address set. (E2 should set this during the first power - up sequence where the user will be asked in which Subnet to put the controller (E2 will always be Node = 1 on the network).</p> <p>If the LED is blinking, then try resetting the E2. If this does not correct the problem, replace the Echelon board.</p> <p>ON (no blinking): Replace the Echelon board. The Neuron processor has lost its application program.</p>

Table 8-5 - Echelon LED Status

8.8 Open Echelon Device Connectivity

Open-Echelon E2s must be ordered pre-configured from Retail Solutions. Open-Echelon licenses must be purchased and enabled on units, and are not transferrable to other units without assistance from Retail Solutions. Call 770-425-2724 for technical assistance or your sales representative. Your sales representative will know which devices your unit will connect to.

8.8.1 Configuring Echelon Devices

Login to the controller and enter the desired number of Echelon devices to be added in the Connected I/O screen. From the Main Menu:

1. Select (System Configuration)
2. Select (Network Setup)

3. Select **2** (Connected I/O Boards and Controllers)

Enter the number of Echelon devices you wish to add on the Connected I/O screen:

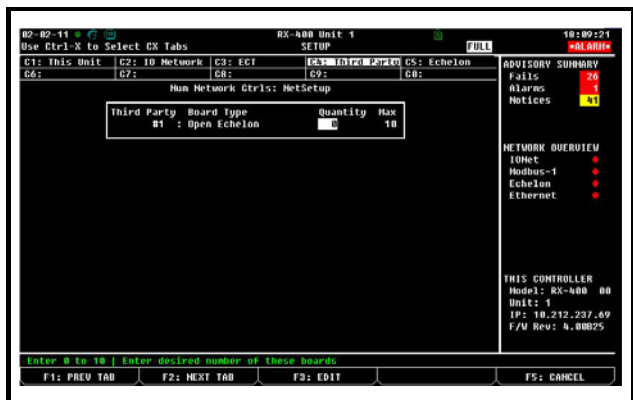

Figure 8-5 - Connected I/O Setup Screen (RX Unit Shown)

Navigate to the **Open Echelon** field under the **Third Party Tab** section of the Connected I/O setup screen and enter the number of Echelon devices to be added.

Next, commission the Echelon device. Commissioning is done at the Controller Setup screen. If still on the Connected I/O screen, hit the back button to go back to the Network setup menu and select **3** (Controller Setup). Or, from the Main Menu:

1. Select **7** (System Configuration)
2. Select **7** (Network Setup)
3. Select **1** (Network Summary)

Commission the device on the Network Summary screen:

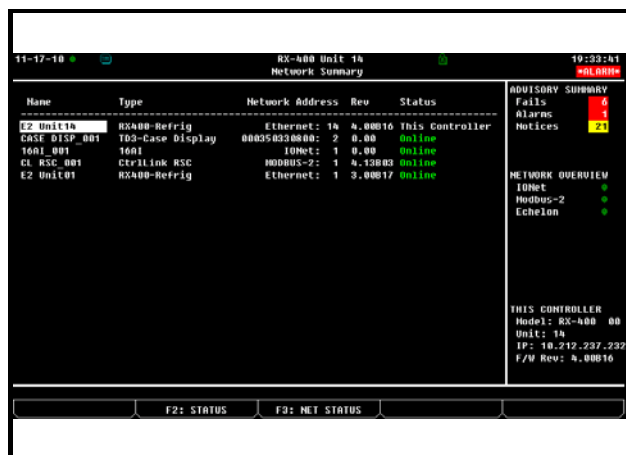

Figure 8-6 - Network Summary Screen (RX Unit Shown)

Highlight the LonMark device on the screen you wish to commission and follow the steps in **Section 10.14.2, Commissioning a Device** to commission the device.

8.8.1.1 Troubleshooting

After commissioning has been completed, check to make sure the device has been added successfully. From the Main Menu, select **5** (Configured Applications) to open the Configured Applications list. If the device you have commissioned does not appear in this list, the Description File has failed to upload correctly onto the E2. An alarm of **No Description File** will be generated and can be found in the Alarm Advisory Log. Call Retail Solutions at 770-425-2724 to contact your sales representative or technical assistance to obtain the Description File.

CC-100/CS-100 INSTALLATION GUIDE

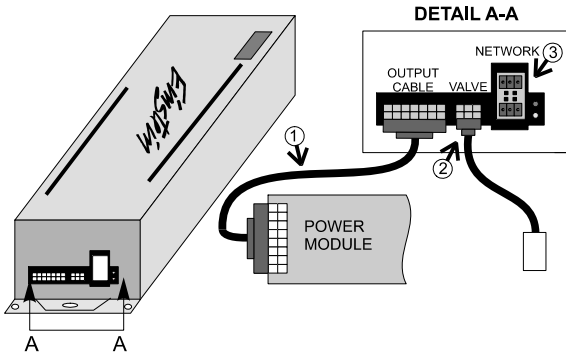

1. Connect CC-100 to power module using output cable P/N 335-3258. If not using a CPC power module, clip the connector from the cable, and wire based on the pinout shown below.

2a. If using a pulse valve, connect to the CC-100 using valve cable P/N 335-3263.

2b. If using a Sporlan SEI or Alco ESR stepper valve with four-pin connector, connect valve to CC-100/CS-100 using valve cable P/N 335-3261.

2c. If using a stepper with no four-pin connector, connect valve to CC-100/CS-100 using valve cable P/N 335-3260.

3. Wire the CC-100/CS-100 to Echelon network.

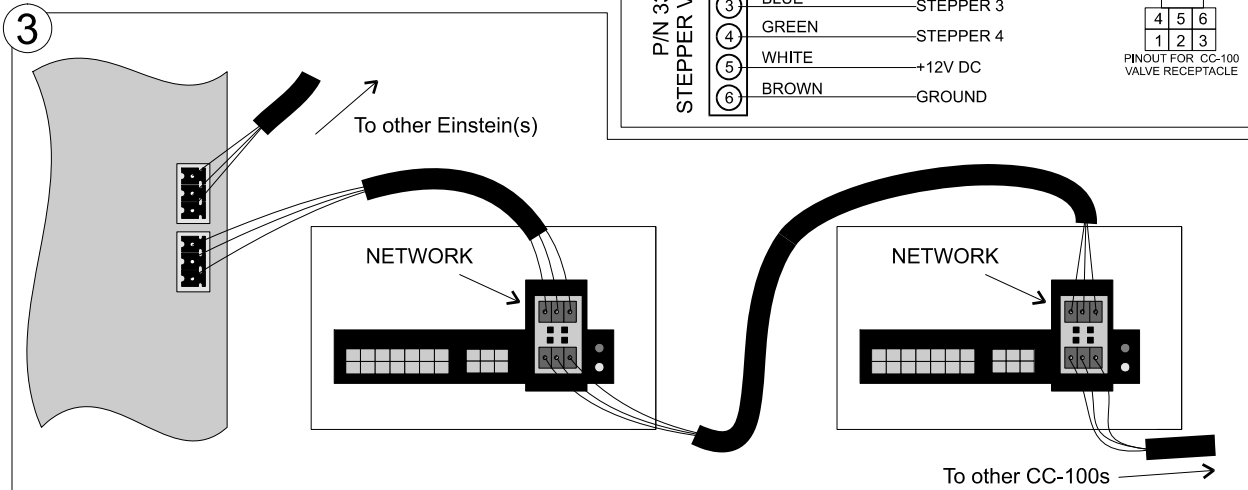
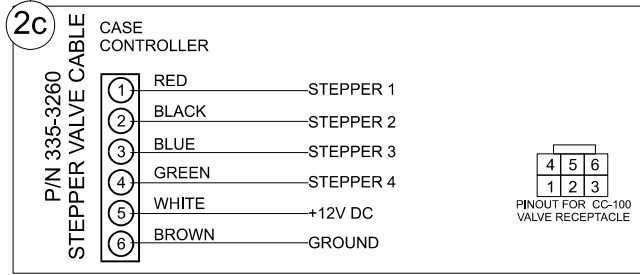
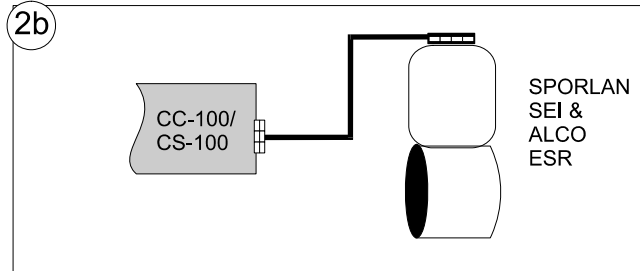
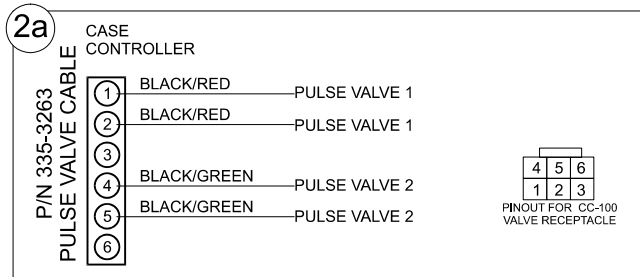
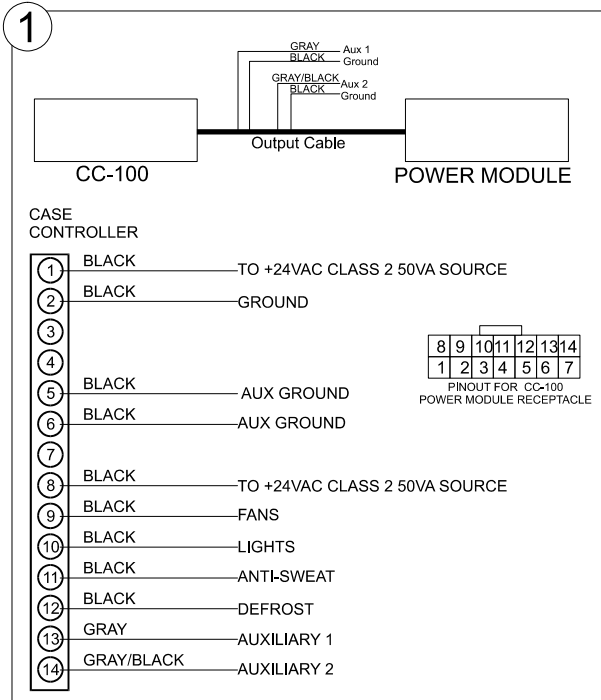

ESR8 INSTALLATION GUIDE

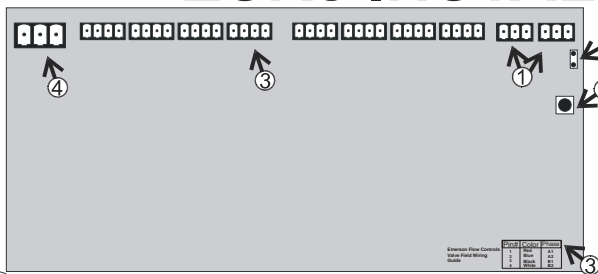

1. Connect the ESR8 to the Echelon Network.
2. Set the termination jumper on the ESR8. For daisy chain configurations, the device will need to be terminated only if at either end of a daisy chain.
3. Wire each Emerson Flow Controls ESR12 or ESR20 valve to one of the four-pin connectors on the ESR8. (Refer to the Emerson Flow Controls Valve Field Wiring Guide.) Use Belden #9418 18AWG or equivalent.
4. Connect the ESR8 to a Class 2, 75 VA 24VAC transformer.
5. Use the Service Button to commission the ESR8. Refer to section 8.14.4 in this manual for more information on commissioning a device. Note that dip switches (S2 & S3) are not implemented.

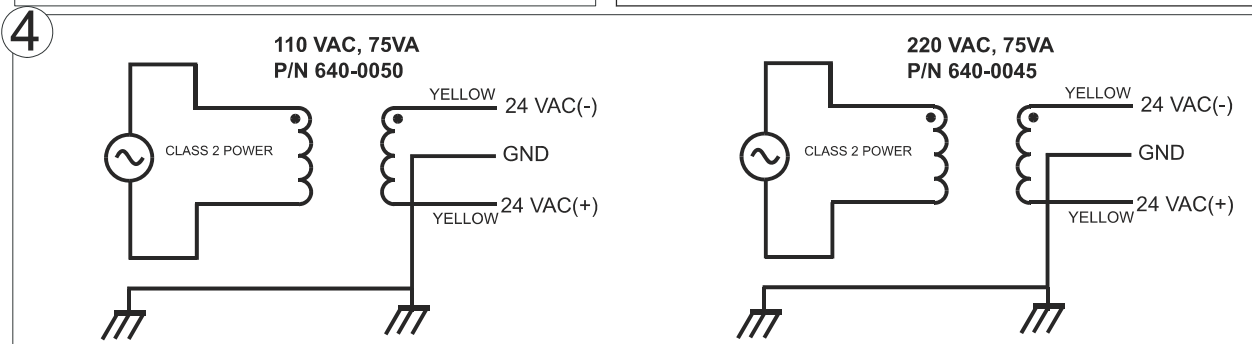
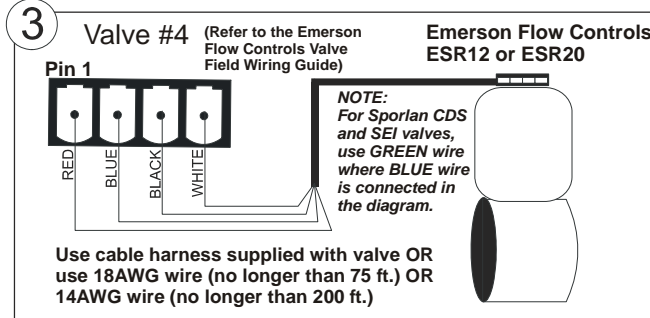
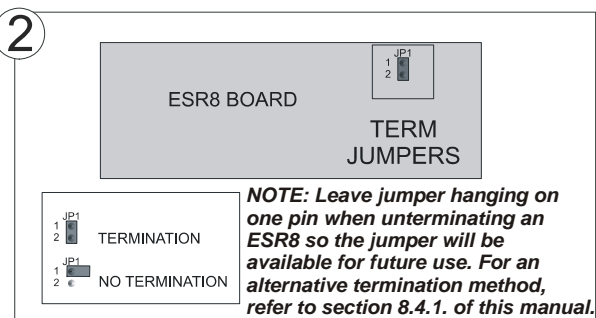
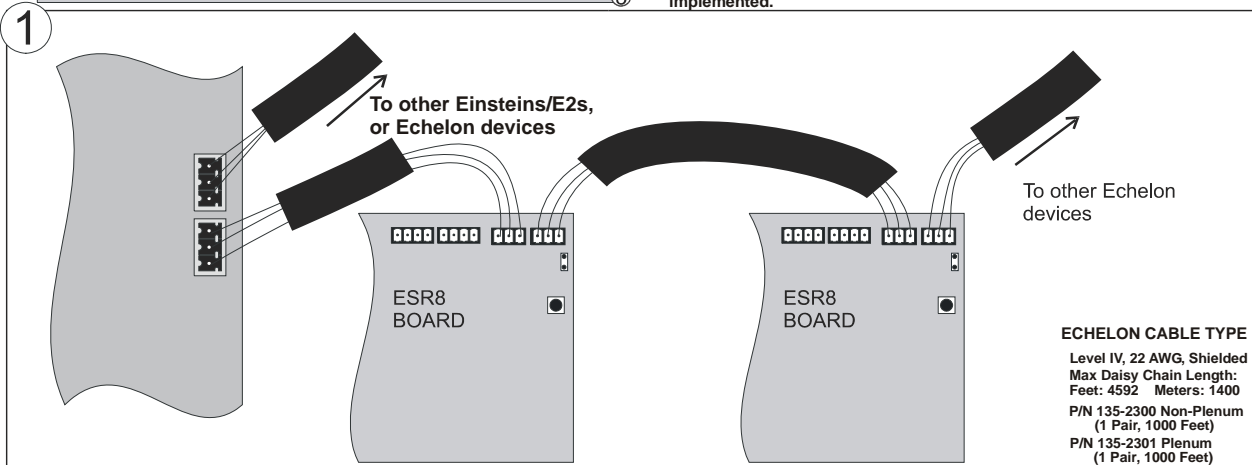

- 5**
- Select board in Controller Network Config screen
 - Press "SET ADDRESS" Function Key
 - Select the "Service Pin" option
 - Enter a wait time (hrs:mins:secs)
 - Press Enter.
- ← PRESS & HOLD FOR 5 SECONDS
SERVICE

TD3 INSTALLATION GUIDE

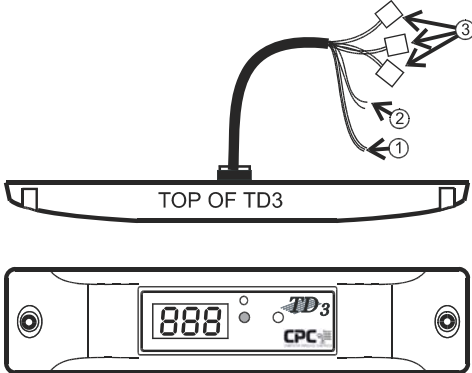

1. Connect the two BLUE flying leads on the TD3 harness to the Echelon network.
2. Wire the GREEN, WHITE, and ORANGE leads on the TD3 harness to the discharge air probe, the product temperature probe, and the defrost termination sensor respectively.
3. Connect the two RED leads and the GREEN/BLACK ground lead to a Class 2 24VAC transformer rated at 4VA or greater.

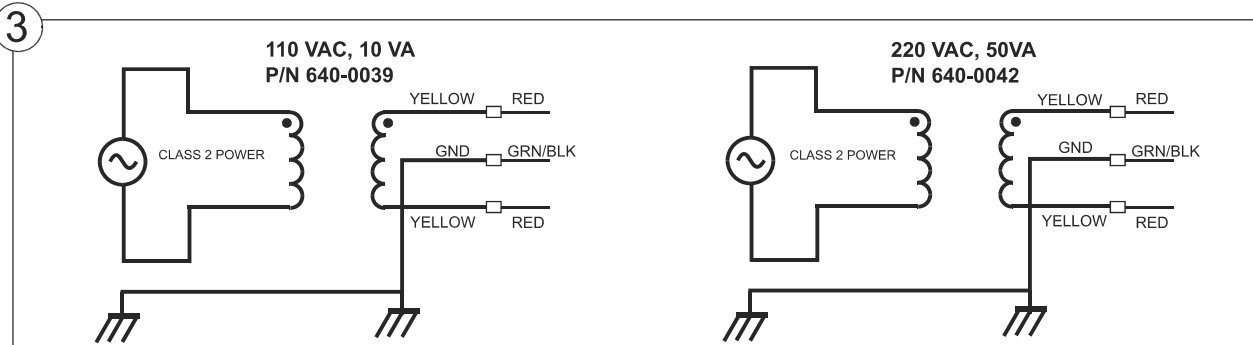
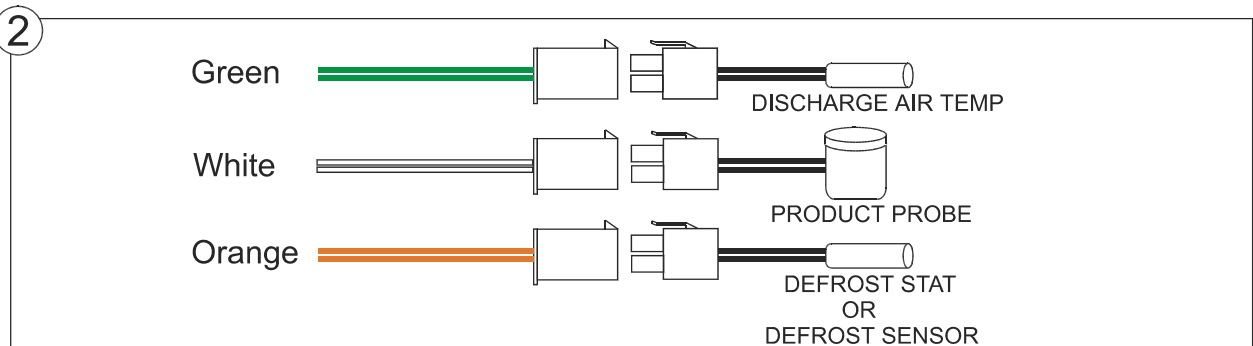
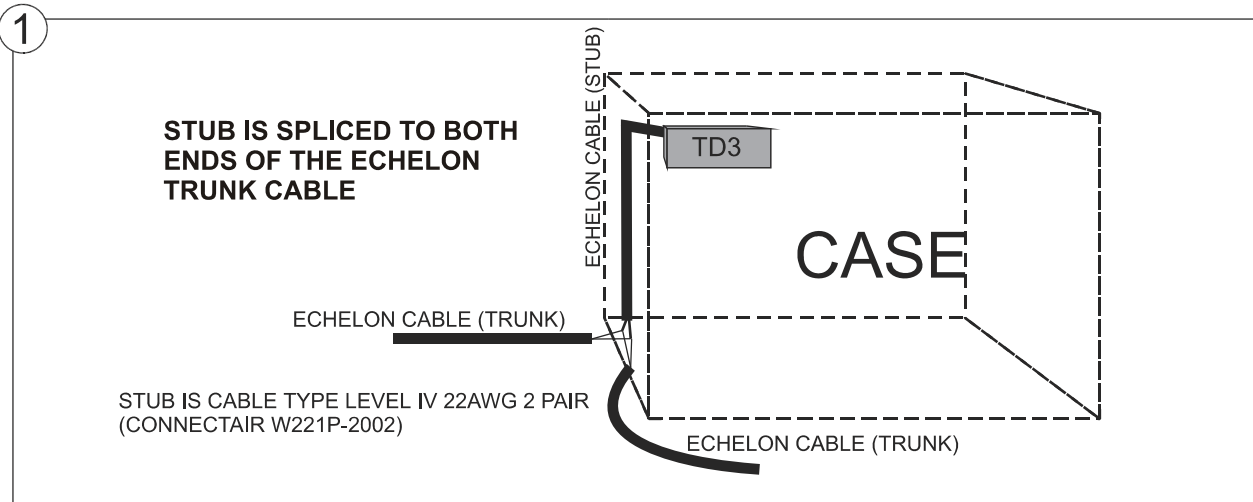

9 Input and Output Setup

9.1 The 16AI, 8IO, and MultiFlex Inputs

9.1.1 Connecting Sensors to Input Boards

There are five I/O Network boards that may accept inputs: the MultiFlex, the 16AI, the ARTC, and the 8IO Combination Input/Output Board. Wiring an input to these boards requires three steps:

1. Connect the sensor's signal wires to the two terminals of an input point.
2. Set the input type dip switch that corresponds to the point being connected.
3. If necessary, connect *the power lead of the sensor* to one of the 5V or 12V power terminals.

9.1.1.1 Wiring

MultiFlex Boards

An input point connector on a MultiFlex, 16AI, and 16AIE board consists of two terminals, as shown in *Figure 9-1*. One of these terminals, labeled "SIG", reads the signal from the sensor, while the other, labeled "0v" is where sensor's ground and/or cable shield wire is connected.

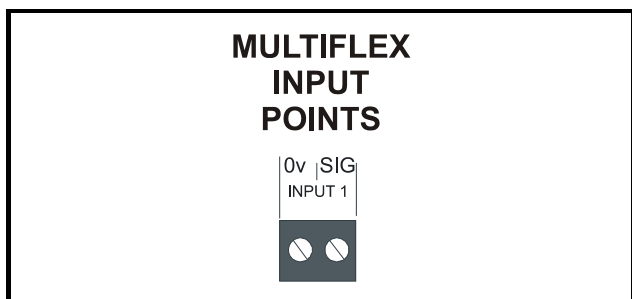

Figure 9-1 - Input Board Points

16AI Boards

On a 16AI, terminals are numbered 1-32, starting with the first terminal of point 1 and ending with the last terminal of point 16. The even-numbered terminals of a 16AI are always where the signal voltages are connected. The sensor grounds and cable shields are connected to the odd-numbered terminals.

8IO and ARTC Boards

On an 8IO board, the two terminals of every point are labeled "-" or "+". The ground wire is always connected to the "-" terminal, and the signal wire is connected to the

"+" terminal.

On the ARTC board, the input and output points are predefined and are labeled accordingly.

9.1.1.2 Sensor Wiring Types

Specific wiring types are required for each type of sensor used with E2.

All Analog Temperature Sensors and Air Flow Sensors

Temperature and air flow sensors are to be wired with shielded, 2 conductor, at least 22 GA wire (Belden # 8761 or equivalent).

All Pressure Transducers, Humidity Sensors, and Refrigeration Transducers

Pressure and refrigeration transducers and humidity sensors are to be wired with shielded, 3 conductor, at least 22 GA wire (Belden #8771 or equivalent).

Dewpoint and Light Level Sensors

These sensors are to be wired with shielded, 4 conductor at least 22 GA wire (Belden # 8729 or equivalent).

9.1.1.3 Input Type Dip Switches

An input type dip switch must be set for each input point. Input type dip switches are located in the switch banks labeled S1 and S2 on the MultiFlex, 16AI, and switch bank S4 on the 8IO.

The input type dip switch tells the input board whether or not the sensor connected to the point requires a DC supply voltage in order to operate. If the sensor requires DC voltage, the dip switch should be set to the DOWN position. If the sensor does not require power, or if it uses AC power, the dip switch should be set to the UP position. Dip switches for unused points should be set to the UP position.

The dip switch positions for each specific sensor type is shown in *Figure 9-2*.

9.1.2 Power Connection

If power is needed to operate the sensor, several terminals exist on the 16AI, MultiFlex boards, 8IO, that may be used to supply DC power (see *Figure 9-3* for 16AI and MultiFlex power connections).

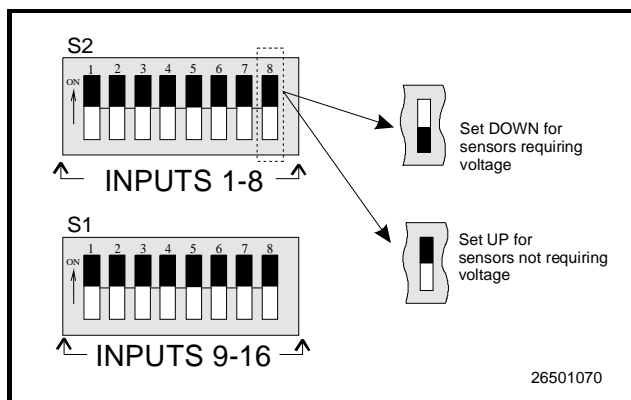

Figure 9-2 - Input Type Dip Switches for MultiFlex 16 and 16AI Boards

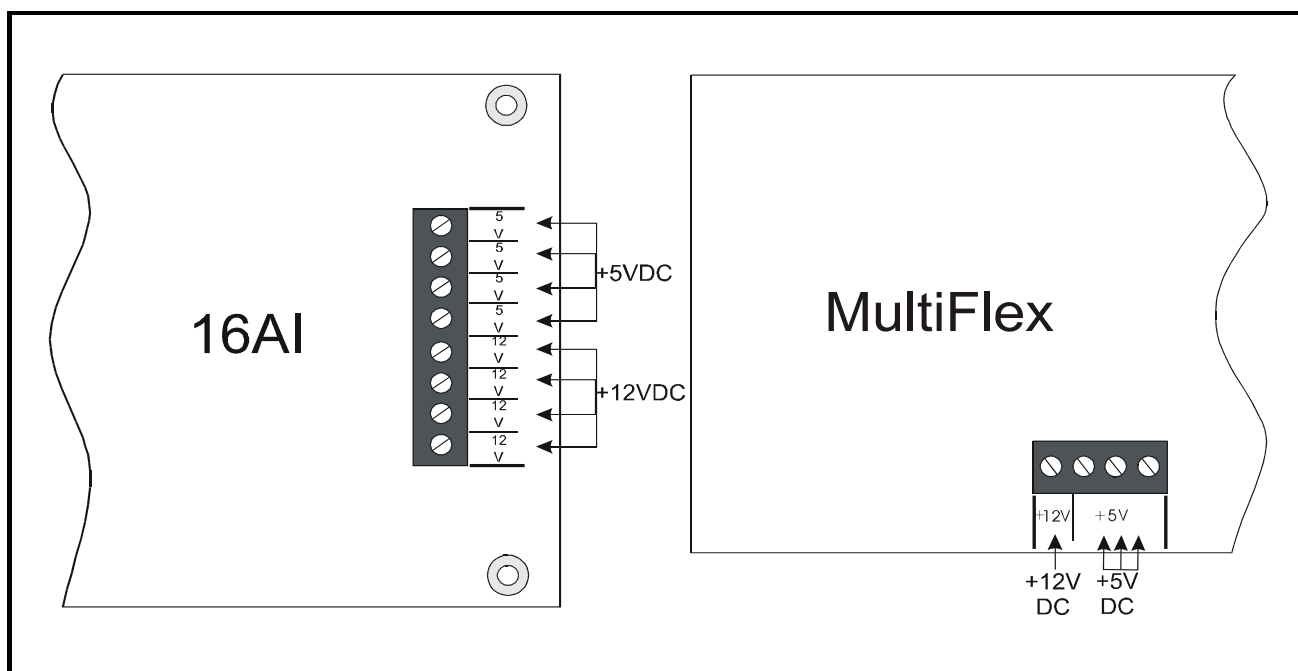

Figure 9-3 - Input Board Power Sources

Input boards may supply 12VDC or 5VDC. To connect to one of the DC power sources, simply connect the sensor's power wire to one of the terminals.

The maximum current that may be drawn from the +12VDC terminal is 100 milliamps. The maximum current that can be drawn from all three +5VDC terminals COMBINED is 50 milliamps.



NOTE: For 24VAC sensors, a separate transformer must be used unless specified otherwise in Table 9-1 on page 9-3.

Specific wiring instructions for each type of sensor are given in Table 9-1 on page 9-3.

P/N	Sensor	Input Type Dip Switch	Wiring
various	Temp Sensors and Probes	Up	<p>1. Connect one lead to the odd numbered terminal and the other lead to the even numbered terminal (polarity insensitive).</p> 
various	Digital Sensors (Klixons, Sail Switches, etc.)	Up	<p>1. Connect one lead to the odd numbered terminal and the other lead to the even numbered terminal (polarity insensitive).</p> 
800-2100 800-2200 800-2500	Pressure Transducers (Retail Solutions) 100, 200, 500 lb. ratings (0.5-4.5VDC output, 5VDC input voltage)	Up	<p>1. Connect RED power wire to +5VDC supply on input board.</p> <p>2. Connect WHITE signal wire to even numbered terminal.</p> <p>3. Connect BLACK ground wire to odd numbered terminal.</p> <p>4. Connect the bare SHIELD wire to odd numbered terminal.</p> 
203-5750	Relative Humidity Sensor	Down	<p>1. Wire the "P" sensor terminal to 12VDC supply on board.</p> <p>2. Wire the "GND" sensor terminal to odd numbered terminal.</p> <p>3. Wire the "OUT" sensor terminal to even numbered terminal.</p> <p>4. Jumper sensor terminal "N" to sensor terminal "GND".</p> 

Table 9-1 - Sensor Wiring

P/N	Sensor	Input Type Dip Switch	Wiring
203-5751	Wall-mounted relative humidity (RH) sensor	Down	<ol style="list-style-type: none"> 1. Use Belden #8771 shielded three-conductor cable or equivalent. 2. Connect the RED, BLACK, and WHITE wires to the screw terminals the sensor's connector as shown in <i>Figure 2</i>. Clip the SHIELD wire. 3. Connect the SHIELD and BLACK wires to the 0V terminal of the input board. Connect the WHITE wire to the SIG terminal of the input board. 4. Connect the RED wire to the +12V power terminal on the input board. 5. Locate the input dip switch for the sensor point, and set to the OFF position (LEFT for MultiFlex, DOWN for 16AI). Refer to the input board's user manual for locations of the input dip switches. 
210-2002	Wall-mounted dewpoint sensor	Down	<ol style="list-style-type: none"> 1. For wiring the sensor to a Retail Solutions input board, use Belden #8761 shielded two-conductor cable or equivalent. 2. Connect the BLACK and WHITE wires to the screw terminals on the sensor's connector as shown in <i>Figure 3</i> (connect BLACK to Signal Ground and WHITE to 0-5V Output). Clip the SHIELD wire. 3. Connect the SHIELD and BLACK wires to the 0V terminal of the input board. Connect the WHITE wire to the SIG terminal of the input board. 4. Connect 24VAC (a separate 120VAC/24VAC transformer must be used P/N 640-0039) to the power terminal on the dewpoint sensor back plate using the BLACK and WHITE wires. (This 24VAC transformer must only be used to power this dewpoint sensor. Do not use this transformer to power additional devices.) 5. Locate the input dip switch for the sensor point, and set to the OFF position (LEFT for MultiFlex, DOWN for 16AI). Refer to the input board's user manual for locations of the input dip switches. 
206-0002	Light Level	Down	<ol style="list-style-type: none"> 1. Wire GREEN ground wire to odd numbered terminal. 2. Wire YELLOW and RED signal wires to even numbered terminal. 3. Wire the POWER wire to a +12VDC source on input board. 

Table 9-1 - Sensor Wiring

P/N	Sensor	Input Type Dip Switch	Wiring
207-0100	Analog Liquid Level	Down	<ol style="list-style-type: none"> 1. Connect RED power wire to +12VDC source on input board. 2. Connect BLACK ground wire to odd numbered terminal. 3. Connect GREEN signal wire to even numbered terminal. 
207-1000	Refrigerant Level Transducer (Hansen Probe)	Down	<ol style="list-style-type: none"> 1. Wire BLACK ground wire from "GND" sensor terminal to odd numbered board terminal. 2. Wire GREEN signal wire from "SIGNAL" sensor terminal to even numbered board terminal. 3. Wire RED power wire from "POWER" sensor terminal to +12VDC terminal on board. 
203-1902	Dewpoint Probe	Up	<ol style="list-style-type: none"> 1. Connect the WHITE and GREEN wires to AC1 and AC2 power terminals. 2. Connect BLACK ground wire to odd numbered board terminal. 3. Connect RED signal wire to even numbered board terminal. 

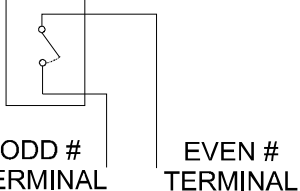
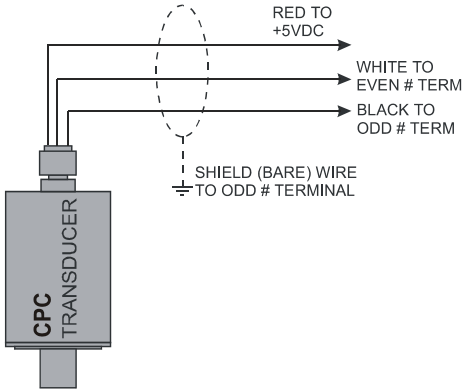
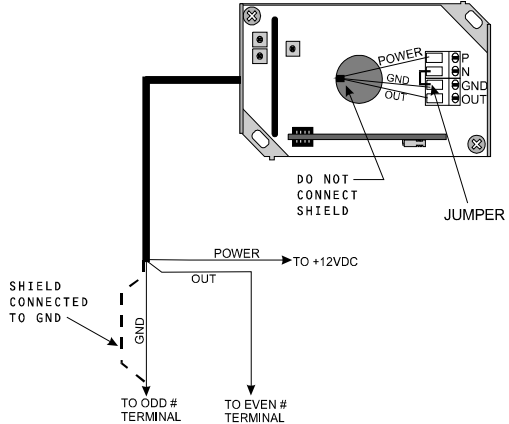
Table 9-1 - Sensor Wiring

P/N	Sensor	Input Type Dip Switch	Wiring
550-2500 550-2550	KW Transducer	Down for 4-20mA, Up for Pulse	<p style="text-align: center;">4-20 mA output to input board</p> <ol style="list-style-type: none"> Wire positive transducer terminal to positive 24VDC supply. Wire negative transducer terminal to odd numbered input terminal. Wire negative 24VDC supply to even numbered input terminal. Place 250Ω resistor across odd and even numbered input terminals. <p style="text-align: center;">Pulse Accumulator output to input board</p> <ol style="list-style-type: none"> If the input board is an 8IO or a 16AI version E.02 or greater, connect the two KWh terminals to the input point (polarity insensitive) If the input board is a 16AI version less than E.02, connect the KWh terminals to board point 1. Set input switch #1 DOWN, and set input switch #8 UP. If the input board is a 16AIe, connect the two KWh terminals to input # 1, 2, 3, or 4 ONLY.

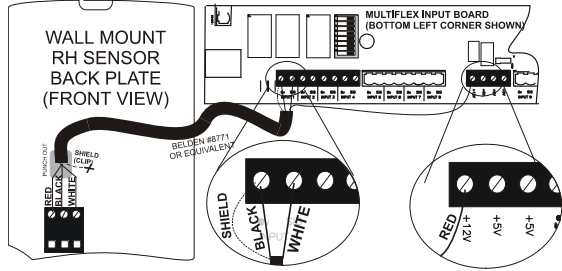
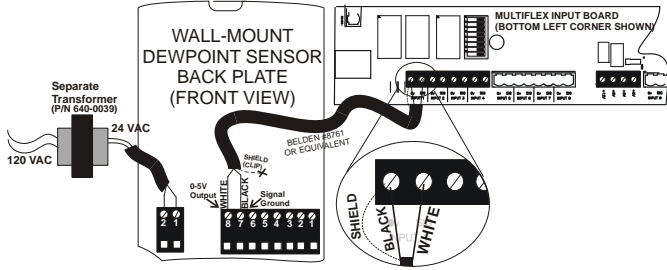
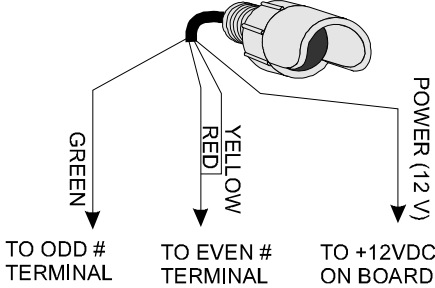
Table 9-1 - Sensor Wiring

9.1.3 Input Setup in E2

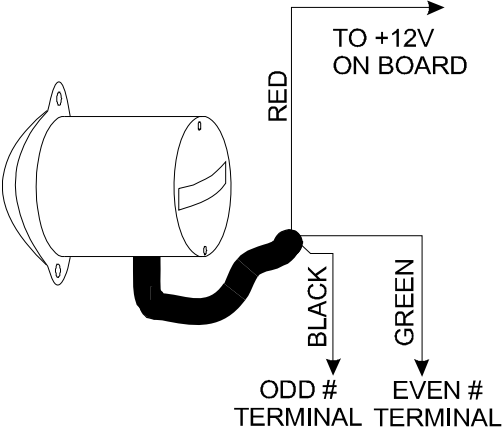
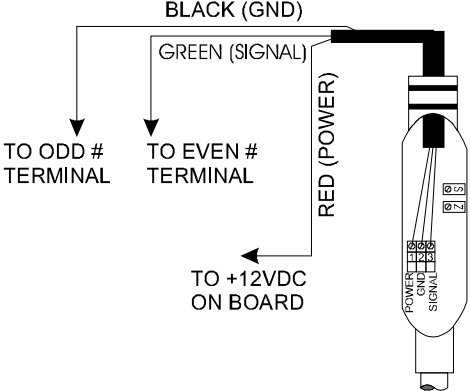
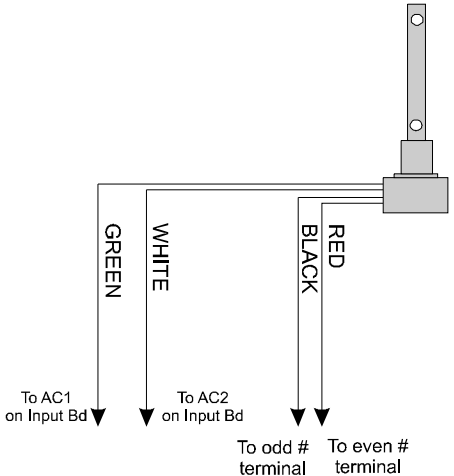
At this point in the setup process, you should have all sensors, transducers, and other input devices wired to points on MultiFlexes, 16AIs, and all output devices connected to 8ROs, 8DOs, or 4AOs outputs. Once the physical wiring is complete, you will need to tell E2 the types of sensors or devices that are connected to each I/O point. This is achieved in the Input and Output Definitions screens.

9.1.3.1 Configuring a Point from the Input Definitions/Status Screen

To configure a point, go to the Input Definitions/Status screen by pressing Alt + I or:

- Press to open the Main Menu
- Press (System Configuration)
- Press (Input Definitions)

The Input Status screen opens:

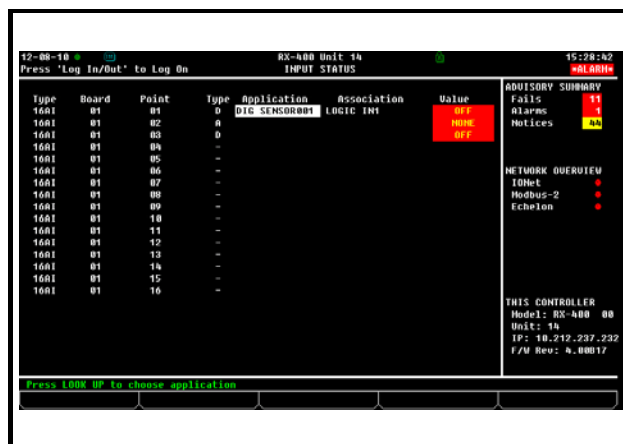

Figure 9-4 - Input Status Screen

Use the up and down arrow keys to move the cursor to the point you wish to set up, and press (SETUP).

A pop-up menu such as the one shown in **Figure 9-5** will prompt you to specify the point as analog or digital. Press if the input is analog, press if the input is dig-

ital, or press **F5** to cancel setup.

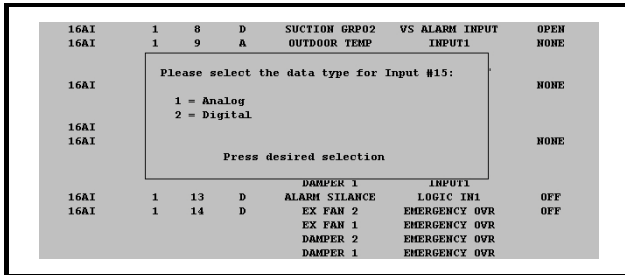

Figure 9-5 - Data Type Pop-Up Menu

Depending upon what type of input you selected, the Analog Input or the Digital Input screen will appear. The analog screen is described in Section 9.1.3.3, while the digital screen is described in Section 9.1.3.4.

9.1.3.2 Using the Input Definitions/Status Screen

In order for the E2 to properly read an input value from a sensor or transducer hooked to an I/O board, you must first tell the E2 what kinds of devices are hooked into each input board point. This is achieved by using the Input Definitions/Status screen. **F1** (SETUP), **F2** (DEL/MOD), **F3** (OFFSET), **F4** (LOOK UP), and **F5** (CANCEL) are the function keys along the bottom of the screen available for the Input Definitions/Status screen.

Each record in this screen contains the following information about a point:

1. Type (read-only)

The **Type** column will read **16AI** regardless of whether the input board is a 16AI, MultiFlex 16, 8IO, or MultiFlex Combination I/O board.



NOTE: When setting up 88s and 8AOs, remember that there are only eight usable input points, even though the 16AI that represents the 88s and 8AOs in the summary screen has sixteen points. Only inputs one through eight (1-8) may be defined; all other points will be ignored.

This is also true of 168DOs and 1616DOs. The MultiFlex 168DO's and 1616DO's digital output's position appears as an 8DO, but only the first four outputs are usable.

2. Board (read-only)

The point's board number will appear in its point record under the **Board** column. All input boards on a controller will be displayed.

3. Point (read-only)

The point number of each point appears in its record under the **Point** column.

4. Type (read-only)

The **Type** field shows the output's data type. Possible Types are: **A** (Analog) or **D** (Digital). If the point has not been identified, a "-" will appear in the field instead.

5. Application

Select which application you wish to set up inputs to. Pressing **F4** (LOOK UP) when on a defined point will open the Application Selection menu--a list of application types currently existing in the box. **F5** (CANCEL) will cancel this menu.

6. Association

If a point has already been defined and is currently being used by an application, the name of the input to which the point is connected will be displayed in the **Association** field.

Association is the application's user-defined property that is associated with the point. Multiple applications attached to single input will all be displayed in the **Association** field. Pressing **F4** (LOOK UP) on a set application will bring up a list of property selections. **F5** (CANCEL) will cancel this menu.

7. Value (read-only)

Value shows the sensor value in the units you select for the input type.



NOTE: When changes are made to the Application or Association fields, data will not be saved until attempting to arrow off of that particular board and point or attempting to leave the screen. If Type has changed, data will be saved and then the controller will take you to the Setup In screen.

9.1.3.3 Setting Up Analog Inputs

Open the Analog Input screen by selecting an Analog (**A**) input from the Input Status screen Figure 9-4 and pressing **F1** (SETUP).

The Analog Input screen Figure 9-4 is where sensor types, units, and default values are specified for analog input points.

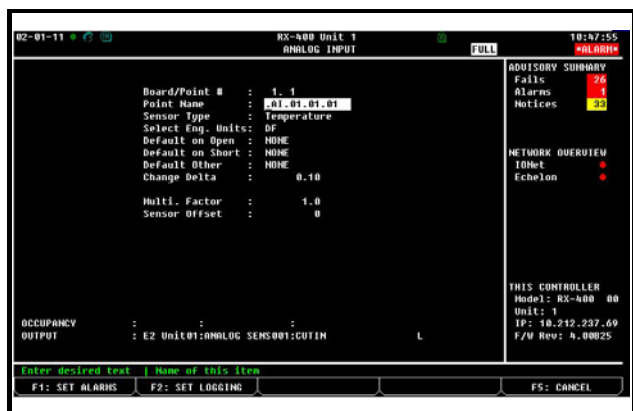

Figure 9-6 - Analog Input Screen

Board/Point # The Board/Point number will automatically be defined if you are configuring the point from the Input Status screen, and indicates the physical address of the board.

Point Name The Point Name is simply a name for the point that may be used as a reference.

Assigning a descriptive name to a point makes setting up inputs for applications much easier. For example, if you have an inside temperature sensor located in Zone 1 of your building, you may name it “ZONE 1 TEMP”. Then, when programming your HVAC applications, you may easily define Zone 1’s temperature sensor input by tying it to ZONE 1 TEMP. This keeps you from having to keep track of which sensors are tied to which point numbers.

You are required to enter a point name in the **Point Name** field. The default name is “:{BOARD NAME}::{UNIT NUMBER}::{BOARD NUMBER}::{POINT NUMBER}.”

Sensor Type The analog input may come from a number of different sensor types.

Sensor Type	Description
Temperature	Retail Solutions Standard Temp Sensor
5V-100 PSI	5VDC 100 PSI transducer (0.5-4.5VDC output)
5V-200 PSI	5VDC 200 PSI transducer (0.5-4.5VDC output)
5V-500 PSI	5VDC 500 PSI transducer (0.5-4.5VDC output)

Table 9-2 - Sensor Input Types

Sensor Type	Description
12V-100 PSI	12VDC 100 PSI transducer (1-6VDC output) (Discontinued)
12V-200 PSI	12VDC 200 PSI transducer (1-6VDC output) (Discontinued)
12V-500 PSI	12VDC 500 PSI transducer (1-6VDC output) (Discontinued)
Refrig. Leak	Refrigerant Leak Detector (not IRLDS)
Refrig. Level	Refrigerant Liquid Level Probe
Liquid Level	Liquid Level Float Sensor
Light Level	Light Level Sensor
Linear	General purpose linear output sensor
Humidity	Relative Humidity sensor
Pulse Accum.	Kilowatt value from KW transducer pulse accumulation readings (see Units Per Pulse on page 9-9)
KW Transducer	Kilowatt transducer using 4-20ma/0-5V signal
Dewpoint	Dewpoint probe
LM235 Temp	Linear voltage output temperature sensor
PT2 Temp	Danfoss PT2 temperature sensor
CDK Temp	CDK 2097MC temperature sensor
20K Pot Adjust	Standard temperature sensor with offset adjustment (potentiometer)
ATP Hi Temperature	Retail Solutions’ 100K High Temperature Sensor (Range 0 - 500 DegF)
86K Temp	Copeland’s integral discharge temperature sensor
2.60V Temp	Danfoss voltage-output temp sensor (2.6V @ 77DegF)

Table 9-2 - Sensor Input Types

Select Eng. Units The engineering units of the sensor value are entered in the **Select Eng. Units** field. This value is set automatically to an appropriate default unit whenever the Sensor Type is changed. To select a different engineering unit, press **Prev** or **Next** to scroll through the options or select the unit from the **F4** (LOOK-UP).

Units Per Pulse The Units Per Pulse field appears only when “Pulse Accum” is entered in the Sensor Type field.

The E2 is capable of generating an analog KW value by counting the number of pulses from the pulse accumulation outputs of a KW transducer. Each pulse from the transducer signifies that a fixed number of KW has been used.

The number of KWs per pulse varies depending upon the type of transducer being used. Consult the transducer’s documentation for the exact number of KWs per pulse and enter it in this field.

Default on Open The value placed here will determine the value the unit reports if there is an “open” condition detected in the sensor input connection. An “open” condition could be the result of a broken wire to the sensor or a sensor failure.

Default on Short The numeric entry in this parameter is the default value the analog input would report if a “short” is detected on the sensor input connection. A “short” could be the result of a damaged wire or a sensor failure.

Default Other The value placed in Default Other is the value reported if the input is not updated after a certain amount of time. If there is a failure that will not allow the input board to report the value of the sensor, the value placed in this parameter will be reported.

Sensor Offset If a sensor needs a numeric value added or subtracted to the calculated value, enter the number here. The value can be positive or negative. Sensors sometimes have to have offsets. The offset that you enter in this field is in the units you selected in the Eng Units field, NOT in millivolts.

Output This field displays the link between the input and the application(s) they feed into. You do not need to enter anything in this field. You will be able to link applications to this point during the application setup process.

9.1.3.4 Setting Up Digital Inputs

Open the Digital Input screen by selecting a Digital (D) input from the Input Status screen *Figure 9-4* and pressing **F1** (SETUP).

Set up digital inputs in order to assign digital input points, point names, engineering units, and other important parameters.

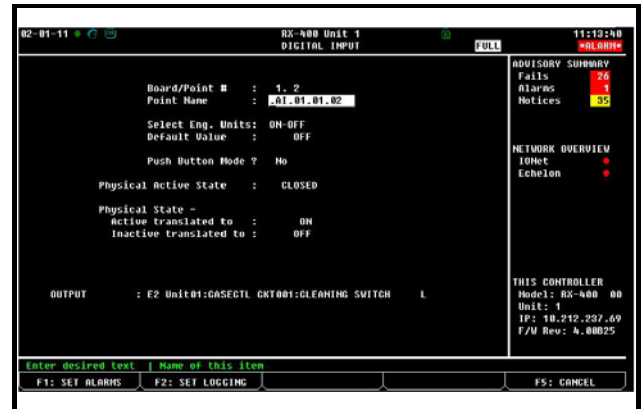

Figure 9-7 - Digital Input Screen

Board/Point # The Board/Point Number will automatically be defined if you are configuring the point from the Input Summary Screen, and indicates the physical address of the board.

Point Name The Point Name is simply a name for the point that may be used as a reference.

Assigning a descriptive name to a point makes setting up inputs for applications much easier. For example, if you are setting up a push-button switch to reset compressor 1 after an oil failure shut down, you may choose to name it “OIL RESET 1”. Then, when programming your Pressure Control application, you may easily define compressor 1’s reset input by tying it to OIL RESET 1. This keeps you from having to keep track of which contacts are tied to which point numbers.

You are required to enter a point name in the **Point Name** field. The default name is “:{BOARD NAME}:{UNIT NUMBER}:{BOARD NUMBER}:{POINT NUMBER}.”

Select Eng. Units The Select Eng. Units field is where you may select how the ON and OFF states of this point are displayed and represented in E2’s setup fields and status screens. By default, digital inputs have ON-OFF engineering units, meaning when the input is ON or OFF, the input will be represented as “ON” or “OFF” in the system software.

Since the controller looks at only the actual state of the point when it uses the input for control purposes, it is not necessary to define engineering units for digital inputs. However, selecting units that are appropriate to the input’s function (such as BYP or NO_BYP for inputs that initiate bypasses) will make

the input's state easier to read and understand.

To choose an engineering unit, press **F4** (LOOK UP) to select.

Push Button Mode? Digital inputs may be set up as “push button” inputs by changing this field to “YES”. Push Button Mode is used to detect when a push button (Momentary) switch has been pressed. When a button press is detected, the input will turn ON for one second, and then turn OFF. If the push button is pressed multiple times, the input will turn ON and back OFF for the same number of times that the button was pressed. The pushbutton input is designed to be connected to any application that has a BYPASS input. It may also be connected to the input of the Pulse Accumulator application to track the number of times the button has been pressed.

If the pushbutton input is connected to an application's BYPASS input, a single button push will cause the application to go into bypass. If the push button is pressed three times within ten seconds, the application will then cancel the bypass. An application must be in bypass mode for at least one minute before it may be cancelled.

Output This field displays the link between the input and its application(s). You do not need to enter anything in this field. You will be able to link applications to this point during the application setup process.

9.2 The 8RO, 8IO, and MultiFlex Outputs

The 8RO, 8IO, and MultiFlex combination I/O boards have relay outputs that close when called to be ON and open when called to be OFF. When an output point is closed (ON), the LED directly above the output terminal glows red. These boards use Form C contacts that determine if the connection will be open or closed during power failure. A fail-safe dip switch is used to determine connection status during network failure.

9.2.1 Wiring Form C Contacts

Figure 9-8 shows how to wire the three-terminal Form C contact.

One wire of the two-wire connection should always be connected to the middle terminal. The second wire must be connected to the N.C. terminal (if you want the relay to be closed (ON) during power failure) or the N.O. terminal (if you want the relay to be (OFF) during power failure).

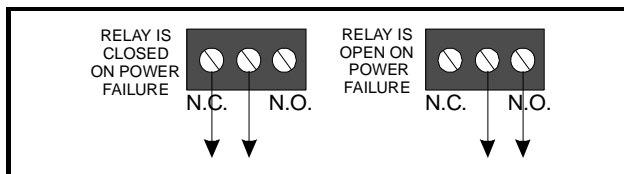

Figure 9-8 - Form C Contact Wiring

9.2.2 MultiFlex Relay Outputs

The MultiFlex boards that have relay outputs (all models except the MultiFlex 16) each have eight relays that energize and de-energize to control output loads.

When setting up an output on one of these relays, you must make two important decisions:

1. Do you want an ON command from your controller to mean “energize the relay” or “de-energize the relay,” and
2. When the relay is de-energized, as is the case when the 8RO or 8IO goes off-line or loses power, do you want the contacts to be OPEN or CLOSED?

Decision #1 is made by setting the **fail-safe switch**. This is a bank of eight switches labeled S2 on the 8RO, and 8RO-FC, S3 on the 8IO, and S1 on the MultiFlex plug-in output board. Each switch corresponds to an output on the board (switch #1 = output #1, etc.).

Decision #2 is made either by setting a **fail-safe jumper** (for old-style 8ROs) or by wiring the load to either the N.O. or N.C. terminals on the Form C contact

(all other output boards).

Table 9-3 shows how the fail-safe switch, jumpers, and/or Form C contacts should be configured based on how you want the output to perform during both normal operation and during network/power loss.

Controller Command vs. Contact State	Fail State	Set Switch To:	Set Jumper or Wire Form C Contacts To:
ON=CLOSED OFF=OPEN	ON	UP	N.C.
ON=CLOSED OFF=OPEN	OFF	UP	N.O.
ON=OPEN OFF=CLOSED	ON	DOWN	N.O.
ON=OPEN OFF=CLOSED	OFF	DOWN	N.C.

Table 9-3 - Output Board Fail-Safe and Switch Settings

9.2.3 Setting the Fail-Safe Dip Switch

The fail-safe dip switch determines the state of the relay when communication is lost between the board and E2. The fail-safe dip switches are labeled S2 on the 8RO, and switch S3 on the 8IO. Each of the eight rockers on the fail-safe dip switch corresponds to an output on the board. Set the rocker UP to close the relay and turn the output ON during network failure. Set the switch DOWN to open the relay and turn the output OFF during network failure.

9.2.4 Relay Output Test Mode

Newly released versions of the MultiFlex I/O board family and the 8ROSMT have a new feature that allows relays to be manually energized and de-energized without use of an override from a Hand-Held Terminal when the board is offline. When a MultiFlex is in Relay Output Test Mode, the output fail-safe dip switches may be used to cycle the states of the relay outputs. The feature is designed to help manufacturers of panels test output wiring quickly and easily without need for a site controller or HHT.

Relay Output Test Mode is available in the following

product versions:

Board Type	Version
8RO-SMT output board	1.20F01 and above
MultiFlex 168, 88, 168AO, and 88AO combination input/output boards	1.60F01 and above
MultiFlex 168DO combination input/output boards with digital outputs	1.60F01 and above
MultiFlex 1616LAO and 1616LDO combination input/output board	1.30F01 and above
MultiFlex 1616L combination input/output board w/o analog outputs	1.20F01 and above

To activate Relay Output Test Mode for MultiFlex, set switches 1-8 on DIP Switch banks S3 and S4 to the OFF (LEFT) position. For 8ROSMT, set switches 1-8 on DIP Switch bank S1 (NETWORK) to the OFF (DOWN) position. The board will enter Relay Output Test Mode.

In Relay Output Test Mode, fail-safe dip switches 1-8 (located on the output board layer of MultiFlex I/O boards, and next to switch bank S1 on the 8ROSMT) can be used to change the state of the relays.

A fail-safe switch in the ON position will cause the corresponding relay to be energized (i.e., OPEN on the N.C. terminals, and CLOSED on the N.O. terminals). A fail-safe switch in the OFF position will cause the relay to be de-energized (i.e., CLOSED on the N.C. terminals and OPEN on the N.O. terminals).

The LED that shows the output state will also be ON when the switch is ON and OFF when the switch is OFF.

To exit Relay Output Test Mode, set the address switches S3 and S4 to any position other than “all OFF.” The fail-safe switches will resume normal operation.

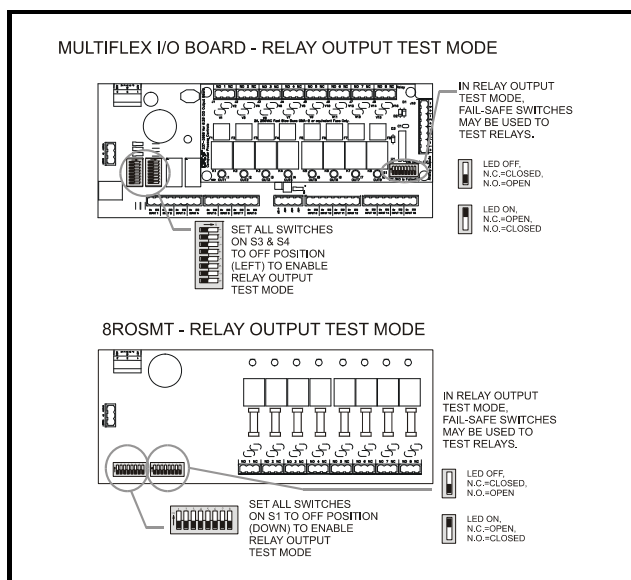

Figure 9-9 - Relay Output Test Mode for MF I/O Board

9.2.5 Wiring Outputs to Points

Old 8ROs

The old design of 8RO (P/N 810-3002) used points with two terminals on them. To connect output devices to these points, wire the point terminals in series with the load, so that the path is closed when the 8RO relay is CLOSED and open when the 8RO relay is OPEN.

New 8ROs and 8RO-FCs

All other E2-compatible output boards, including the new design of 8RO (P/N 810-3005), the 8RO-FC, and have Form C contacts. *Figure 9-8* shows how to wire the three-terminal Form C contact.

One wire of the two-wire 8RO-FC connection should always be connected to the middle terminal. The second wire must either be connected to the N.C. terminal (if you want the path to be closed when the relay is de-energized) or the N.O. terminal (if you want the path to be open during power failure).

9.2.6 The Output LED

Each output point on an output board has an indicator LED that shows the status of the output. This LED is lit to show the output is ON, and unlit to show the output is OFF.

The definition of ON and OFF in this case is determined by the position of the fail-safe dip switch (see *Table 9-3*). Therefore, if the output's switch is UP, an illuminated LED means the path is CLOSED, but if the switch is DOWN, an illuminated LED means the path is OPEN.

9.2.7 Output Setup in E2

In order for the E2 to properly control devices that are hooked to an I/O board, you must first tell the E2 what type of output the devices require. This is achieved from the Output Definitions/Status screen.

9.2.7.1 Configuring a Point from the Output Definitions/Status Screen

To configure a point, go to the Output Definitions/Status screen by pressing Alt + O or:

1. Press **Menu** to open the Main Menu
2. Press **&7** (System Configuration)
3. Press **@2** (Output Definitions)

The Output Status screen opens:

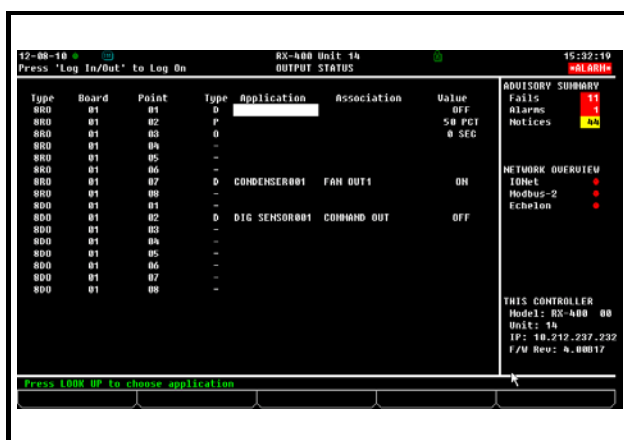

Figure 9-10 - Output Status Screen

To configure a point, use the up and down arrow keys to move the cursor to the point you wish to set up, and press **F1** (SETUP).

If you press **F1** to set up a 4AO output point, the E2 will automatically transfer you to the Analog Output screen *Figure 9-6*. For all other output board types, pressing **F1** will bring up a pop-up menu such as the one shown in *Figure 9-11*. This menu will prompt you to specify the output as either Digital, Pulse, or One Shot. Press **1** if the output is Digital, press **2** if the output is Pulse, press **3** if the output is One Shot, or press **F5** to cancel setup.

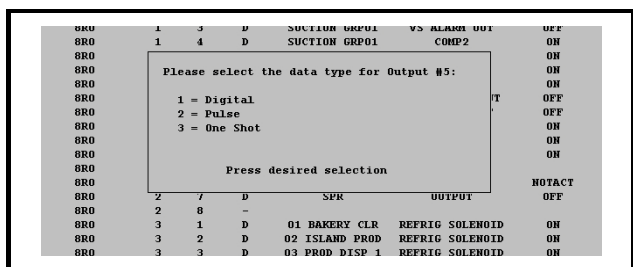

Figure 9-11 - Output Data Type Pop-Up Menu

Depending upon what type of output you selected, the Digital Output, (see [Section 9.2.7.3, Setting Up Digital Outputs](#)) Pulse Digital Output, or One Shot Digital Output screen will appear.

9.2.7.2 Using the Output Definitions/Status Screen

The Output Definitions/Status screen serves a dual purpose. It is both an at-a-glance summary of all points on each output board and a menu where output points may be selected and configured.

In order for the E2 to properly control devices that are hooked to an I/O board, you must first tell the E2 what type of output the devices require. This is achieved by using the Output Definitions/Status screen.

F1 (SETUP), **F2** (DEL/MOD), **F4** (LOOK UP), and **F5** (CANCEL) are the function keys along the bottom of the screen available for the Output Definitions/Status screen.

The Output Definitions/Status screen serves a dual purpose. It is both an at-a-glance summary of all points on each output board and a menu where output points may be selected and configured.

Each record in this screen contains the following information about a point:

1. Type (read-only)

Board Type shows which kind of output board the point is on. The Board Type field will read either **8RO**, **8DO**, or **4AO** for I/O Network 16AI boards, **E16AI**, and **8ROE** for Echelon Network 16AIE boards.

The last character of the Board Type field also shows what type of input the point is defined as. If a point has already been defined as an analog or digital input, this field will signify its input type with an “A” (for analog) or “D” (for digital).

2. Board (read-only)

The point’s board number appears under the **Board** field.

3. Point (read-only)

The point number of each point appears in its record in the **Point** field.

4. Type (read-only)

The **Type** field shows the output’s data type. Possible Types are: **A** (Analog), **D** (Digital), **O** (One Shot), or **P** (Pulse). If the point has not been identified, a “-” will appear at the end of the field instead.

5. Application

Select which application you wish to set up inputs to. Pressing **F4** (LOOK UP) when on a defined point will open the Application Selection menu--a list of application types currently existing in the box. **F5** (CANCEL) will cancel this menu.

6. Association

If a point has already been defined and is currently being used by an application, the name of the input to which the point is connected will be displayed in the **Association** field.

Association is the application’s user-defined property that is associated with the point. Multiple applications attached to single input will all be displayed in the **Association** field. Pressing **F4** (LOOK UP) when on a set application will bring up a list of property selections. **F5** (CANCEL) will cancel this menu.

7. Value (read-only)

Value shows the sensor value in the units you select for the output type.

9.2.7.3 Setting Up Digital Outputs

Open the Digital Output screen by selecting a Digital (**D**) input from the Output Status screen [Figure 9-10](#) and pressing **F1** (SETUP).

Digital Outputs are ON when the E2 calls for them to be ON, and OFF whenever the E2 calls for them to be OFF. Most outputs that directly activate and deactivate output devices will need to be set up as the Digital output type.



Figure 9-12 - Digital Output Screen

Board/Point # The Board/Point Number will automatically be defined if you are configuring the point from the Output Status screen, and indicates the physical address of the board.

Point Name The Point Name is simply a name for the output point that may be used as a reference.

Assigning a descriptive name to a point makes setting up outputs for applications much easier. For example, if you are setting up condenser fan #3 for condenser #2, you may choose to name it “CND #2 FAN #3”. Then, when programming your Condenser Control application, you may easily define the fan output by tying it to CND #2 FAN #3. This keeps you from having to keep track of which contacts are tied to which point numbers.

You are required to enter a point name in the Point Name field. The default name is “:{BOARD NAME}:{UNIT NUMBER}:{BOARD NUMBER}:{POINT NUMBER}”.

Select Eng. Units The **Select Eng. Units** field is where you may select how the ON and OFF states of this point are displayed and represented in the E2’s setup fields and status screens. By default, digital outputs have ON-OFF engineering units, meaning when the output is ON or OFF, the input will be represented as “ON” or “OFF” in the system software.

Engineering units are only a visual representation of the state of the output point (energized or de-energized). Therefore, it is not necessary to define engineering units for digital inputs. However, selecting units that are appropriate to the output’s function (such as BYP or NO_BYP for inputs that initiate bypasses) will make the output’s state easier to read and understand.

To choose an engineering unit, press **F4** (LOOK UP) to select.

Default Value The value that the relay output should go to if the output is not associated to an application. The default value of the **Default Value** field is **OFF**.

Physical On Specifies whether the physical relay output should energize or de-energize its coil when the logical output is on.

Physical Off Specifies whether the physical relay output should energize or de-energize its coil when the logical output is off.

Physical Null Specifies whether the physical relay output should energize or de-energize its coil when there is no application associated with the output.

Minimum Physical On Time Specifies the minimum time the physical output must remain on regardless of the logical output state.

Minimum Physical Off Time Specifies the minimum time the physical output must remain off regardless of the logical output state.

PRIORITY OVR When an input is overridden to an output cell. If this input is not set to **NONE**, it will be used for the output value instead of the input value, but only for the override timeout period.

Priority Override Timeout When an input goes on it will override to a value for the timeout period.

INPUT This field links the output to an application. You do not need to enter anything in this field. You will be able to link applications to this point during the application setup process.

9.2.7.4 Setting Up Analog Outputs

Open the Analog Output screen by selecting an Analog (A) output from the Output Status screen *Figure 9-10* and pressing **F1** (SETUP).

This is where output types, units, and default values are specified for analog output points.

In most cases, only the point name will need defining in this screen, unless you wish to change the 0-10V output range or configure a priority override.

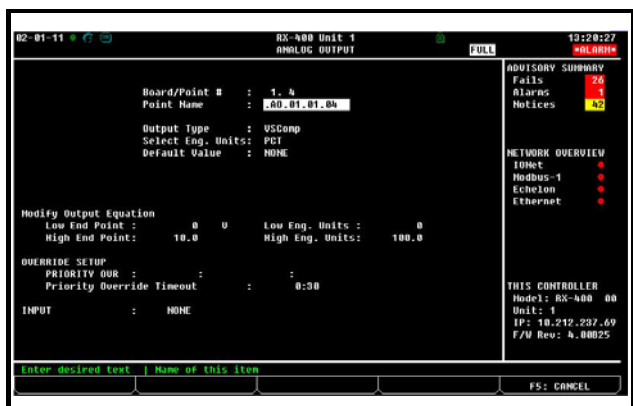

Figure 9-13 - Analog Output Screen

Board/Point # The Board/Point Number will automatically be defined if you are configuring the point from the Output Definitions screen, and indicates the physical address of the board.

Point Name The Point Name is simply a name for the output point that may be used as a reference.

Assigning a descriptive name to a point makes setting up outputs for applications much easier. For example, if you are setting up fan #3 for Zone 1, you may choose to name it “FAN#1 HT#3”. Then, when programming your Condenser Control application, you may easily define the fan output by tying it to FAN#1 HT#3. This keeps you from having to keep track of which contacts are tied to which point numbers. You are required to enter a point name in the **Point Name** field. The default name is “:{BOARD NAME}:{UNIT NUMBER}:{BOARD NUMBER}:{POINT NUMBER}”.

Output Type The analog output may be either of two types: **Linear** and **VComp**.

Linear means that the output is a standard 0-10VDC linear output.

VComp means that the output is a percentage (0% - 100%) that is driving an inverter that controls a variable-speed device such as a compressor or fan.

If the output will be driving a variable-speed device, choose **VComp** in this field; otherwise, select **Linear**. Use **F4** (LOOK UP) to select.

Select Eng. Units The engineering units of the output value are entered in the **Select Eng. Units** field. This value is defaulted to percent (**PCT**). Use **F4** (LOOK UP) to select.

Default Value The value that the relay output should go to if the output is not associated to an application. The default value of the **Default Value** field is **OFF**.

Modify Output Equation Enables the value to be translated into an output.

Low End Point The output voltage when the **INPUT** is at the value specified in the **Low Eng. Units** field.

High End Point The output voltage when the **INPUT** is at the value specified in the **High Eng. Units** field.

Low Eng. Units The value of the input (in Engineering Units) that will produce the output voltage specified in the **Low End Point** field.

High Eng. Units The value of the input (in Engineering Units) that will produce the output voltage specified in the **High End Point** field.

PRIORITY OVR When an input is overridden to an output cell. If this input is not set to **NONE**, it will be used for the output value instead of the input value, but only for the override timeout period.

Priority Override Timeout When an input goes on it will override to a value for the timeout period.

INPUT This field links the output to an application. You do not need to enter anything in this field. You will be able to link applications to this point during the application setup process.

9.3 CC-100 Case Controllers

9.3.1 Inputs

The input connections to the CC-100 are made on the left-hand side of the controller. **Figure 9-14** shows the CC-100 input connections.

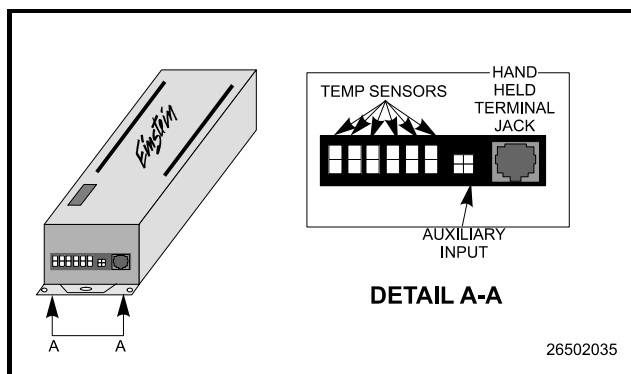

Figure 9-14 - Temperature, Auxiliary and HHT Inputs

Temperature and Digital Sensors

The six two-pin Molex connectors on the left-hand side of the unit (numbered 1 through 6) are where the case's temperature probes, coil inlet/coil outlet sensors, and other digital switches and contacts are connected. Retail Solutions temperature sensor leads are equipped with male connectors that plug in to these receptacles.

For digital switches and sensors such as dual-temp and clean switches, Retail Solutions supplies a digital output harness (P/N 335-3264) that consists of a connector with a two-wire pigtail. These wires may be spliced on to the switch or digital sensor leads. The connector is designed to snap in to one of the six inputs.

Connection

In order to function correctly, the CC-100 needs to know the function of each of the sensors plugged into inputs 1 through 6. For example, a CC-100P liquid pulse controller needs to know which of the six sensors is the coil in sensor, which is the coil out sensor, etc.

Each of the six inputs have a default input type assignment based on the type of CC-100 (either Liquid, or Suction). If the sensors in your case match the default sensor types, plug each sensor into the appropriate receptacle.

Input #	Liquid (CC-100P and CC-100LS)	Suction (CS-100 and CC-100H)
1	COIL IN (Blue)	DISCHARGE TEMP 1 (Green)
2	COIL OUT (Red)	DISCHARGE TEMP 2 (Green)
3	DISCHARGE AIR (Green)	DISCHARGE TEMP 3 (Green)
4	RETURN AIR (Purple)	DISCHARGE TEMP 4 (Green)
5	DEFROST TERM (Orange)	DEFROST TERM (Orange)
6	CLEAN SWITCH	CLEAN SWITCH

Table 9-4 - Default Input Assignments

If your case has sensors or switches that are not listed in the defaults above, or if it is otherwise impossible to use all the defaults for the CC-100, the input type can be changed in the system software.

Auxiliary Analog Input

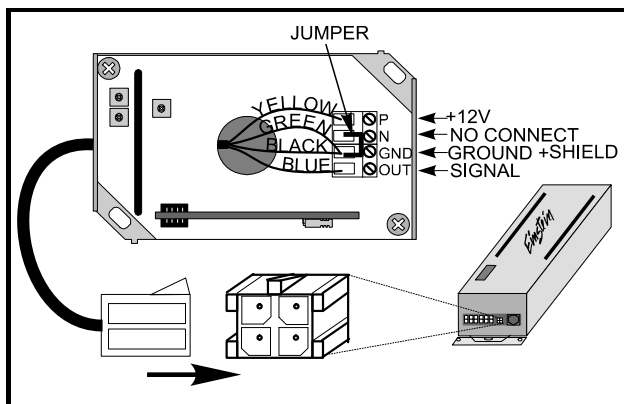

Figure 9-15 - Auxiliary Analog Input

The four-pin analog input is designed to be connected to a Relative Humidity Sensor (P/N 203-5750). The wiring harness (P/N 335-3252) designed specifically for the input must be used. Wiring for this device is shown in **Figure 9-15**.

Hand-held Terminal Jack

The Hand-held Terminal jack on the left side of the CC-100 is where a Retail Solutions Hand-held Terminal (HHT) may be connected. The HHT may be used to program setpoints and change settings in a CC-100. In addition, you may use an HHT to send a case into defrost (or terminate an existing defrost), force a case into wash mode, and bypass or override numerous case functions.

The Hand-held Terminal jack also doubles as a service pin, used when commissioning a CC-100. Plugging the Hand-held Terminal into a CC-100 sends the special Echeleon ID number to the E2.

9.3.2 Power Module Wiring

CC-100s are powered by 24VAC Class 2 power, which is supplied by a Retail Solutions power module.

The case power module should be connected to either a 120 VAC or 240 VAC single phase power source (which ever is necessary for the model ordered). Complete wiring of the case controller power module, including lights, fans, defrost, and anti-sweat heaters, is diagrammed in **Figure 9-16**. Follow all local, NEC, and UL wiring practices.

Power is supplied to the CC-100 via the output cable harness.

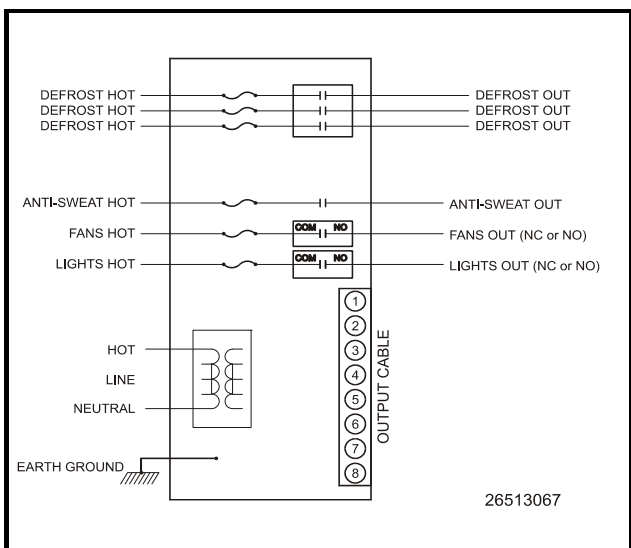

Figure 9-16 - Case Controller and Defrost Power Module Wiring Schematic

9.3.3 Valve Cable

The six-pin connector on the right-hand side of the CC-100 is where the liquid stepper or suction stepper must be connected. The CC-100 uses this connection to control the stepper motors and change the position of the valve aperture.

All valve cable harnesses have a six-pin male connector that plugs into the CC-100's VALVE port. Plug this connector in so that the tab on the top of the connector is facing up.

For instructions on connecting the valve cable to the pulse or stepper valve, refer to the instructions below for the appropriate cable type.

P/N 335-3263 (Pulse Valve)

Figure 9-17 shows the connections for pulse valve 1 and pulse valve 2. The pulse valve 2 leads (BLACK/GREEN) may be clipped if a second evaporator is not present on the case.

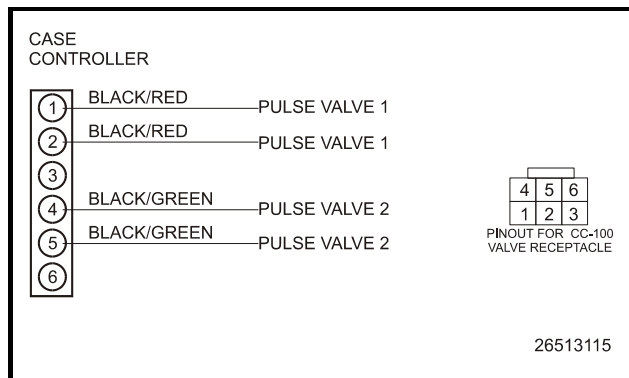

Figure 9-17 - Wiring the 335-3263 Valve Cable

P/N 335-3261 (Sporlan SEI and Emerson Flow Controls ESR Stepper Valve)

The 335-3261 valve cable is equipped with a four-pin male connector that plugs into a four-pin female connector on the valve. Plug the valve cable connector into the valve connector.

P/N 335-3260 (Generic Stepper and Emerson Flow Controls ESV Valve)

The 335-3260 valve cable has six flying leads for connection to a stepper valve. Four of these leads connect to the stepper motors, while the other two serve as the power wiring (+12VDC and ground).

The pinout for this valve cable is shown in **Figure 9-18**. **Table 9-5** shows how to hook the flying leads to Emerson Flow Controls ESR, Emerson Flow Controls ESV, and Sporlan SEI & CDS valves.

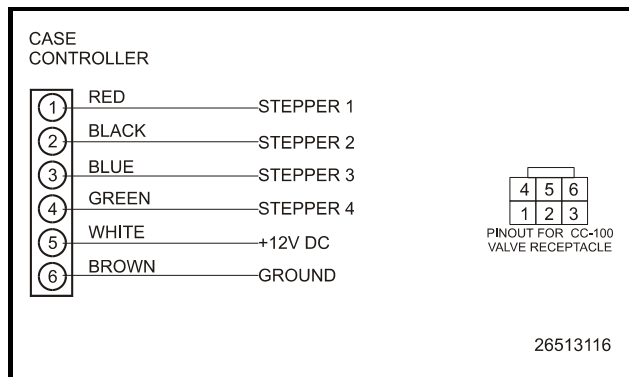

Figure 9-18 - Wiring the 335-3260 Generic Stepper Valve

Wire on Valve Cable 335-3260		Emerson Flow Controls ESR	Emerson Flow Controls ESV	Sporlan SEI&CDS
Pin #	Color			
1	Red	Red	Blue	Red
2	Black	Blue	Red	Green
3	Blue	Black	Black	Black
4	Green	White	White	White
5	White		Yellow	
6	Brown			

Table 9-5 - 335-3260 to Valve Connection Information

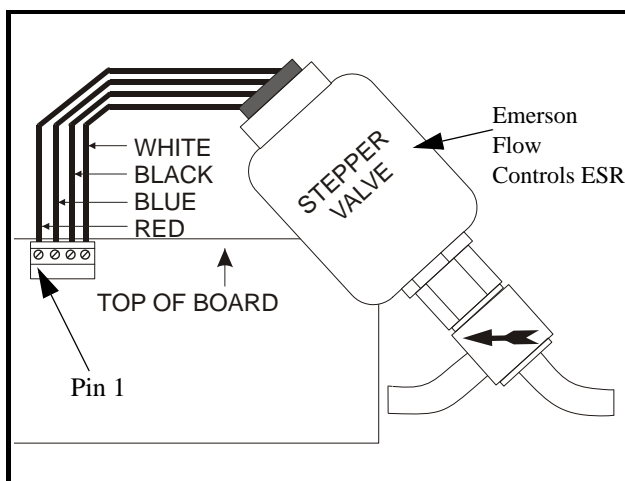

Figure 9-19 - ESR8 Valve Wiring

9.4 CCB Case Controllers

For information on retrofitting E2s in RMCC stores with CCBs, refer to Technical Bulletin #026-4119. For other information about CCB wiring, hand-held terminal programming and operation, refer to the CCB Installation Manual (P/N 026-1110).

9.5 ESR8 and MultiFlex ESR Valve Output Wiring

ESR8 Boards (Discontinued)

For ESR8 boards, the stepper valves are wired to the board by connecting the four-conductor wire from the stepper valve to a connector plug and then plugging in to one of eight jacks along the top of the board **Figure 9-19**. Use the cable harnesses supplied with the valves or use Belden #9418 four-conductor 18AWG wire.

NOTE: A wire run may not be longer than 150 ft. using Belden #9418.

If the stepper valves have block-style connectors, cut the ends off and attach the terminal plugs supplied with the ESR8 to the wire ends.

NOTE: For Sporlan CDS, wire the same as Emerson Flow Controls ESR, but use green wire in place of blue wire.

MultiFlex ESR Board

The stepper valves are wired to the board by connecting the stepper valve harness to one of the eight screw terminal connectors along the top of the board (**Figure 9-20**) and matching the wire colors to the legend on the connectors. Use the cable and cable harnesses that are supplied with the valves.

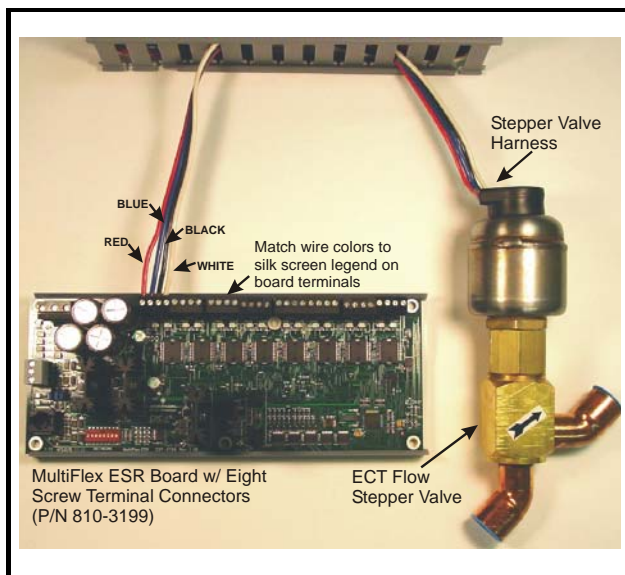

Figure 9-20 - ECT Flow Valve and MFlex ESR Board Wiring



NOTE: A valve cable harness may not be longer than 150 feet.

For Sporlan valves, match all wire colors *except* the green wire. Instead, connect the green wire to the (silk screened) blue wire legend on the board terminals.

For more information on the MultiFlex ERS board, refer to the MultiFlex ESR Installation and Operation manual (P/N 026-1720).

10 Quick Start



This section covers what to do when you are programming a new E2 for the first time. The section includes logging on, specifying information about I/O boards and application types, and other topics related to E2 programming and navigation.



10.1 Logging On



Figure 10-1 - User Login Dialog Box

When the E2 is powered up for the first time, the first screen displayed after initialization is the User Login screen.

1. Enter "USER" in the Username field.
2. Press .
3. Enter "PASS" in the Password field.
4. Press .

Logging into and out of the E2 controller can be done at any time by pressing the  key on the E2 keypad. If you are currently logged out, pressing  will bring up the User Login dialog box. If you are already logged in, pressing  will immediately log you out and return you to the E2 home screen.

10.2 Cleaning Out the Controller

Cleaning out the E2 controller needs to be done if:

- If you are programming your E2 controller for the first time.
- If all of the settings need to be cleared.
- If the program settings are unknown.

Open the E2 controller panel. There are two buttons located midway down on the main board (see **Figure 2-2**). These buttons are used to perform various hardware functions.

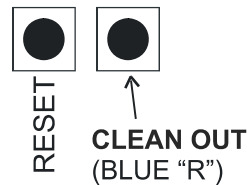

Reset Button - The button labeled "RESET" on the main board resets the controller. Pressing and holding this button for one second will cause the E2 to reset and retain all programmed applications, logs, and other data stored in memory.

Clean Out Button - The button labeled CLEAN OUT on the controller is used to perform a function called **clean out**. Using this button in conjunction with the Reset Button will cause a clean out, which is a reset that **erases all data from memory**. The E2 will re-boot after a clean out with all programmed applications, logs, and other data erased.

Clean outs are also commonly called Blue "R" resets, named for the key presses required to clean out Retail Solutions' previous generation of controllers, REFLECS.

Performing a Clean Out



CAUTION: A clean out will erase all programmed parameters from memory. Do not follow these instructions unless you are absolutely sure you wish to remove all applications and logs from memory.

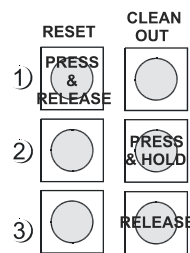

1. Press and RELEASE the Reset Button quickly. The screen will clear.
2. Press and Hold the Clean Out button.
3. When "CLEANOUT" appears in large text across the screen, RELEASE the Clean Out button.

10.3 Setting Number of Network Devices

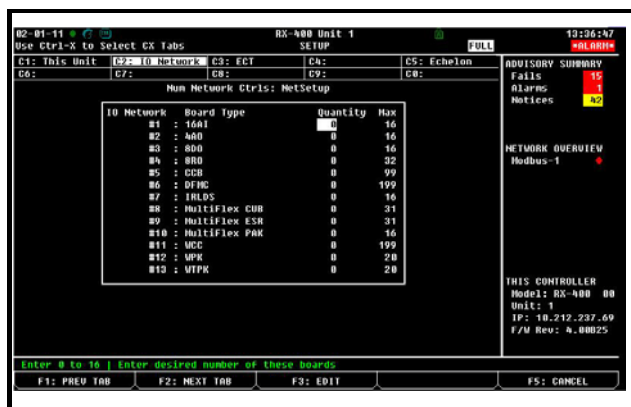

Figure 10-2 - Connected I/O Setup Screen

After logging in for the first time, the Connected I/O screen will ask you to specify how many of each type of device will be connected to the E2 you are currently programming. (Options will vary depending on the type of controller used.)

Unit Number (Echelon Subnet) Each E2 on the Echelon Network must have a different unit number. This can be any number from 1 to 255, but each E2's number must be unique. No two E2s on the network may have the same unit number.

Enter this number in the Unit Number field. It is recommended you number the first E2 "1" and number the other E2s on the network sequentially (2, 3, 4, etc.).

Unit Name Type a name for the E2 in the Unit Name field.

Boards on the I/O Network

16AI Boards Enter the number of 16AIs or MultiFlex I/O boards on this E2's I/O Network. If you have any special MultiFlex or Gateway boards that emulate 16AI, also include their total number of boards in this field.

8RO Boards Enter the number of 8ROs and MultiFlex 168AOs/168s/88AOs relay output boards on this E2's I/O Network.

8DO Boards Enter the number of 8DO digital output boards on this E2's I/O Network.

4AO Boards Enter the number of 4AOs, MultiFlex 168AOs, and MultiFlex 88AO analog output boards on this E2's I/O Network.

IRLDS Controllers Enter the number of IRLDS/RLDS leak detection units on this E2's I/O Network.

Unit Controllers (Echelon)

Liquid Ctrls (CC100P/CC100LS) Enter the combined number of pulse valve case controllers (CC100Ps) and liquid-side stepper valve case controllers (CC100LSs) in this field.

Suction Controllers (CC100H) Enter the number of suction stepper case controllers (CC100Hs) in this field.

Circuit Suction (CS100) Enter the number of suction lineup circuit controllers (CS100s) in this field.

ESR8 Line Up Boards Enter the number of ESR suction lineup circuit boards (SR100s) in this field.

TD3 Temperature Displays Enter the number of TD3 temperature display units in this field.

EC-2 Case Controllers Enter the number of EC-2 refrigerated case controllers in this field.

Echelon 16AI Enter the number of 16AIE analog input boards in this field.

Echelon 8RO Enter the number of 8ROe analog input boards in this field.

NOTE: At any time, you can access this screen to add or remove boards on this E2 by pressing



When finished, press **F5** (NEXT) to move to the next screen.

10.4 Setting Number of Applications

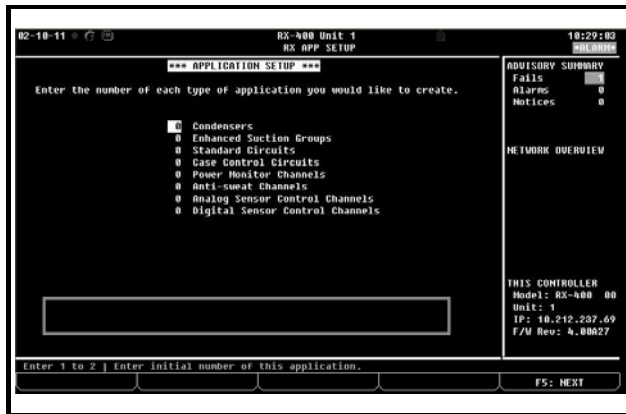

Figure 10-3 - Application Setup (RX version shown)

The Application Setup screen is where you will enter information about the types of devices on the E2's control system. If you know how many applications will be needed, this step will save you time and will keep you from having to create new applications during the setup process. (Options will vary depending on the type of controller used.)

NOTE: You must create at least one application in this screen to continue to the next screen, even if you are only using this E2 to control applications not listed on the screen. If necessary, you can create one application here and delete it later.

When finished, press **F5** (NEXT) to go straight to the Main Status (Home) screen.

10.5 The Main Status (Home) Screen

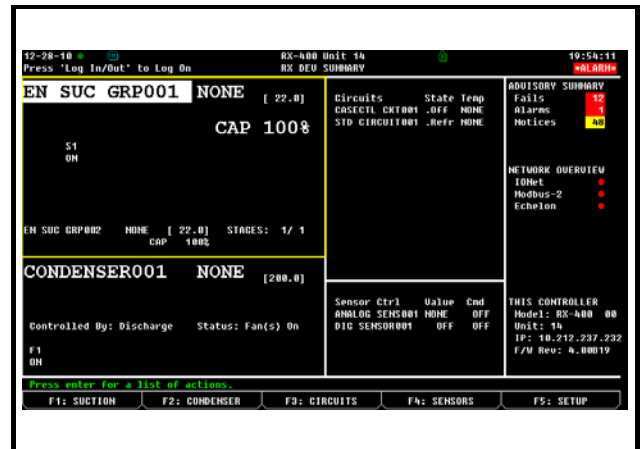

Figure 10-4 - Home Screen (RX version shown)

The Main Status screen is the “home” screen for the E2. When no one is logged in to the controller, this is the screen that will be shown in the display. When a user is logged into the controller, the Home screen is displayed when the user is not performing any actions such as application setup, viewing other status screens, etc.

The Home screen will vary depending on the configuration of the controller. In most cases, the Home screen will show the real-time status of the most fundamental systems being controlled by the E2.

The Home screen is a good place to point out three important common elements of all E2 screens: the screen header, the function key descriptions, and the help line.

Options will vary depending on the type of controller used. For more information on the E2 Home screen including options for both RX and BX versions, see [Section 12.1, The E2 Home Screen](#).

10.5.1 Customizing the Home Screen

The Home screen can be customized to show different information depending on the user's needs. There are eight different screen options available. The **Device Summary** screen is the **Default** screen. See [Section 12.5, Customizing the Home Screen](#) for the steps to customize the Home screen.

10.6 Common Screen Elements

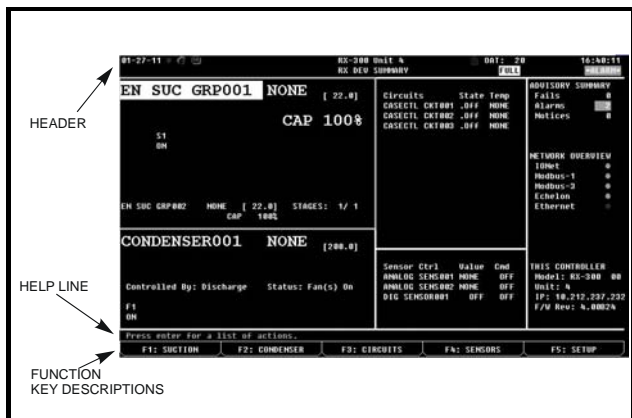

Figure 10-5 - Common Screen Elements (RX version shown)

10.6.1 The Header

The first two lines at the top of the E2 screen are referred to as the **screen header**. This area of the screen contains the time and date, controller name, subnet and node number, and alarm and failure notifications. In addition, it contains highlighted indicators and icons to show when a user is operating in a particular mode, such as full options, edit, macro record, or insert mode.

If the E2's Global Data feature is being used to supply outside air temperature and outside relative humidity values, these values will also be displayed in the header.

10.6.1.1 Header Icons

At the very top of every screen in the E2, there are icons that indicate various stages of activity, number of users logged into the controller, battery alerts, connectivity status, and more.

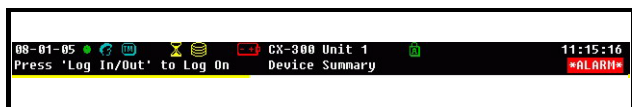

Figure 10-6 - Header Icons

Icon	Description
	Single user is logged in
	Multi-users are logged in
	Terminal mode in use
	E2 is connected to Ethernet
	Wait, or system is busy
	Disk activity, or saving to disk
	Caps lock is ON

Table 10-1 - Header Icons and Descriptions

10.6.2 The Function Keys

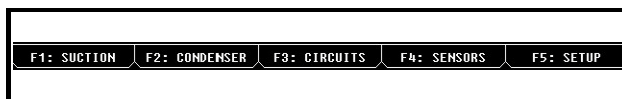

Figure 10-7 - Home Screen Function Keys (RX version shown)

At the very bottom of every screen in the E2, there are five boxes labeled **F1** through **F5**. These boxes are the function key descriptions. The function key descriptions show what each of the five function keys do when pressed. (Options will vary depending on the type of controller being used.)

Function key usage often varies depending on which screen or field E2 is currently in.

10.6.3 The Help Line

The line directly above the function button menu is called the **help line**. The help line displays information about the currently selected field, such as general descriptions, possible ranges, and other information to help a user maneuver around and/or configure the field.



TIP: To see different messages the help line generates, start from the RX Home screen. Press **F3** (CIRCUITS). Highlight a circuit and press . Use the arrow buttons to move around the screen and notice how the help line changes as the cursor moves from the setpoint to status sections. When finished, press the key to return to the Home screen.

10.7 Screen Types

10.7.1 The Main Menu

Each status screen is specially designed to provide a concise at-a-glance view of how one or more systems are functioning.

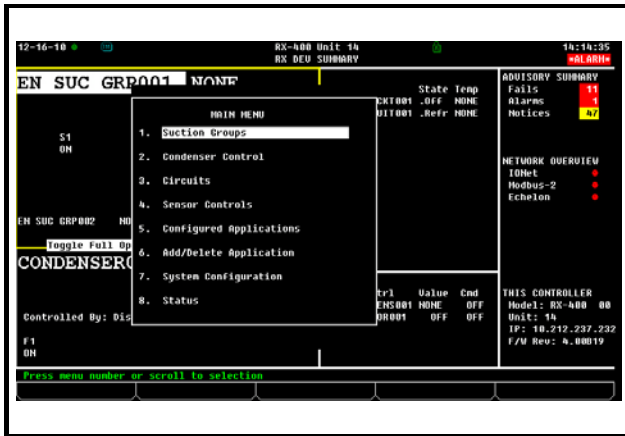



Figure 10-8 - The Main Menu (RX version shown)

The Main Menu is accessed by pressing the  key. This menu gives you direct access to applications such as Suction Groups, Condensers, Circuits, Air Handling Units, Zones, Light Schedules, and Sensor Controls applications, (depending on which controller type you are using) as well as all configured applications in the controller. The Main Menu also allows you to add and delete applications, gives system configuration abilities, and shows status information for inputs and outputs, network, graphs and logs.

10.7.2 Status Screens

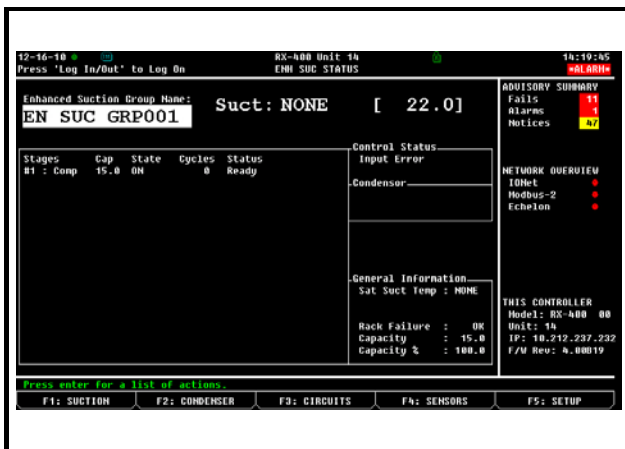



Figure 10-9 - Status Screen (RX version shown)

Status screens are real-time views of application functions. They show the current status of all outputs, the current values of all inputs, and other important data such as control setpoints, run times, and whether or not bypasses or overrides are active.



TIP: To view the Suction Group Status screen in the RX controller, start from the Home screen. Press the function key **F1** (SUCTION GRP). If more than one Suction Group has been set up, the Suction Group Summary screen opens. Choose which application you wish to view with the cursor and press . The current status, runtime, and HP rating for each compressor are displayed in this screen.

To view other application types, use the function keys **F2**, **F3**, and **F4** (see Table 10-2) to see the condenser, circuits, and sensor control status screens.

Key	Function for RX	Function for BX	Function for CX
F1	Suction Group	AHU	AHU
F2	Condensers	Zones	Lighting
F3	Standard and Case Circuits	Lighting	Circuits
F4	Sensor Control and Power Monitoring	Sensors	Sensors
F5	Setup	Setup	Setup

Table 10-2 - Status Screen Function Keys

Status screen functions are explained in more detail in Section 12, *Operator's Guide to Using the E2* of the manual. For now, press  to access another important screen: the Actions menu.

10.7.3 The Actions Menu

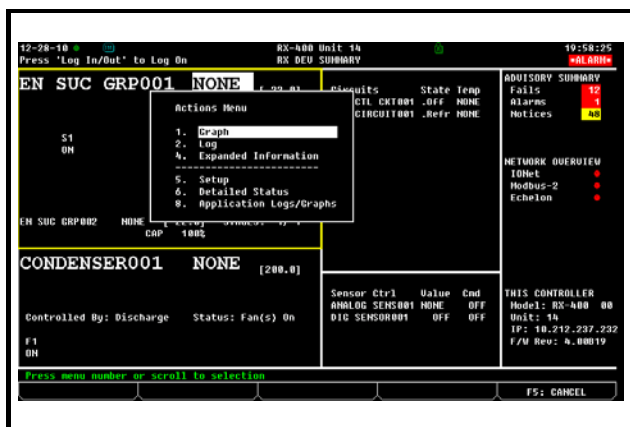



Figure 10-10 - The Actions Menu



The Actions Menu is available from any status screen by pressing Enter , and may be used to do just about any task in the E2 system software. This screen lists a number of options that can be used to affect a selected field, an entire application, or the E2 in general.

Actions Menu Item	Description
Graph	Opens graph view for the selected value.
Log	Opens the Log screen of the selected value.
Override	Opens the Override Update window where the selected input or output can be overridden to a user-defined value or state.
Expanded Information	Displays detailed information about the selected value.

Table 10-3 - Actions Menu Options and Descriptions

Actions Menu Item	Description
Setup	Opens the setup screen for the selected value.
Detailed Status	Special status screen that shows detailed setpoints and input/output information with complete summary of inputs, outputs.
Manual Defrost	For circuits only. Opens the Circuit Bypass screen to force a manual or emergency defrost, or wash mode.
Application Commands	Allows Service Start/End for Irrigation and Pulse Accumulation applications.
Applications Logs/Graphs	<ul style="list-style-type: none"> Opens various log and graph screens for Anti-sweat and Pulse Accumulation applications. Opens the Circuit Report screen for standard circuits only.

Table 10-3 - Actions Menu Options and Descriptions

One of the more important features of the Actions Menu is the Setup screen  (Setup). The actual setup screen will vary, depending on where the cursor is placed in the Main Status (Home) screen before  is pressed. This is the easiest way to edit an existing application.

For more information on usage of the Setup screen and how to implement its functions, see Section 12.11.1.2, *Setup Screens*.

10.7.4 The Setup Screens

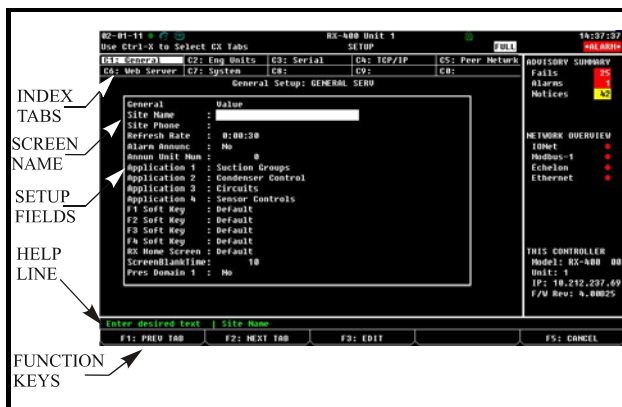

Figure 10-11 - Typical Setup Screen

Setup screens are the interface used to change settings and setpoints, and define inputs and outputs in the E2.

Figure 10-11 shows a typical Setup screen and its primary

elements. For more details on Setup screens, see [Section 10.18.2.3, Navigating the Setup Screen.](#)

10.7.5 System Configuration Menu

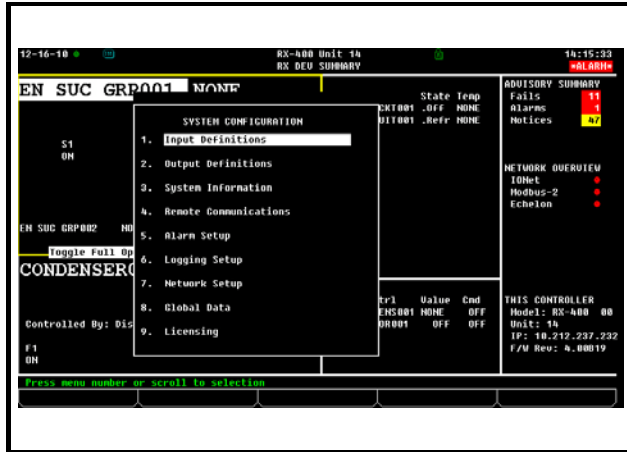

Figure 10-12 - System Configuration Menu

The System Configuration Menu is one of the menus used to set up the E2. Included options are Input/Output Definitions, internal system information, remote communications, global data, alarm, logging, and network setup information.

To open the System Configuration menu:

1. Press 
2. Press  (System Configuration)

The System Configuration menu contains nine menu items:

Menu Option	Description
1 - Input Definitions	View the status of all input boards, as well as set up individual points on the I/O boards.
2 - Output Definitions	View the status of all output boards, as well as set up individual points on the I/O boards.
3 - System Information	Menu that gives access to more E2 setup options and information.
4 - Remote Communications	Gives access to modem information, dial-out setup, and TCP/IP.

Table 10-4 - System Configuration Menu Options

Menu Option	Description
5 - Alarm Setup	Set up dial-outs and alarm reporting for the current E2.
6 - Logging Setup	Enter information about Logging Group applications such as the sampling frequency and total number of samples.
7 - Network Setup	Opens the Network Setup menu, where options to view network status, add or delete boards and controllers, commission devices, set up a router, and make board associations are available.
8 - Global Data	Configure one or more analog or digital sensors to be used as “global” values by all E2s.
9 - Licensing	Opens the Licensing Report page with a list of all licensed features on the current E2, and allows additional features, after a password key has been entered by the user, to be enabled.

Table 10-4 - System Configuration Menu Options

10.7.6 The System Information Menu

The System Information menu contains nine items:

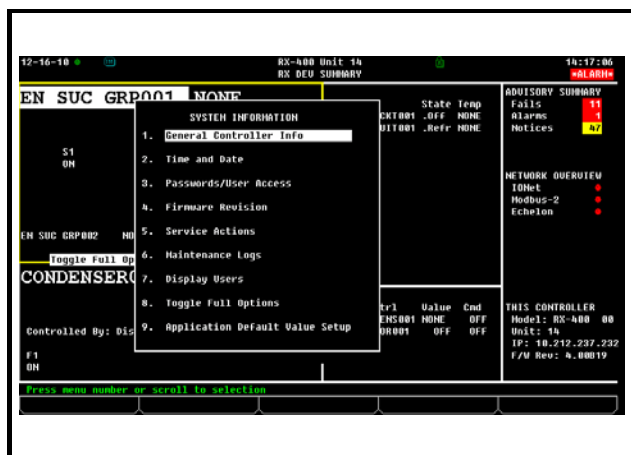

Figure 10-13 - System Information Menu

The System Information Menu is another menu used to set up the E2. The options in this menu allow setting up time and date, passwords, toggle full options, general information about the controller, and system administrator functions.

To open the System Information Menu:

1. Press
2. Press (System Configuration)
3. Press (System Information)

Menu Option	Description
1 - General Controller Info	Edit general information about the E2, such as engineering units, and summer/winter change-over specifications.
2 - Time and Date	Change the current date and time, and specify date formats.
3 - Passwords/User Access	Set up usernames and passwords, and define security level requirements.
4 - Firmware Revision	Read-only information screen that contains current system version information
5 - Service Actions	Set up system diagnostics (memory and execution info), and perform advanced functions (system resets and firmware update).
6 - Note Pad	Writable field for technician to make notes about changes made or general information.
7 - Display Users	Enter information about Logging Group applications such as the sampling frequency and total number of samples.
8 - Toggle Full Options	When set to on, FULL will appear at the top right of the screen and gives user full access to options and applications.
9 - Application Default Value Setup	Choose the default values most appropriate to the refrigeration control components in the system.

Table 10-5 - System Information Menu Options

10.8 Time/Date Setup

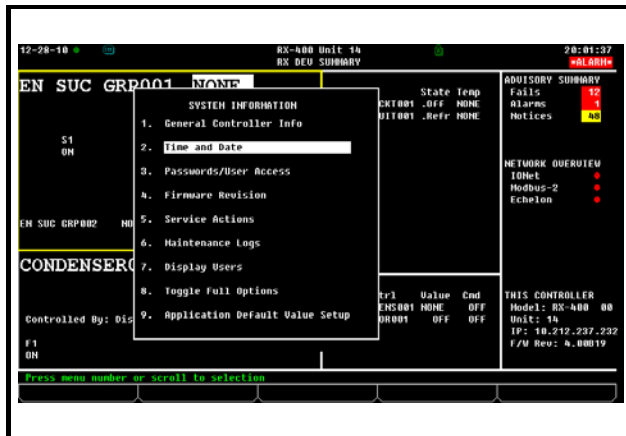

Figure 10-14 - System Information Menu

The Time/Date Setup screen is where users can change the time, date, date format, Daylight Savings Dates, and special time synchronization features.

To get to the Time/Date Setup screen from the Main Menu:

1. Select **&7** (System Configuration)
2. Select **#3** (System Information)
3. Select **@2** (Time/Date)

The Time/Date Setup screen (*Figure 10-15*) is where all time and date changes occur.

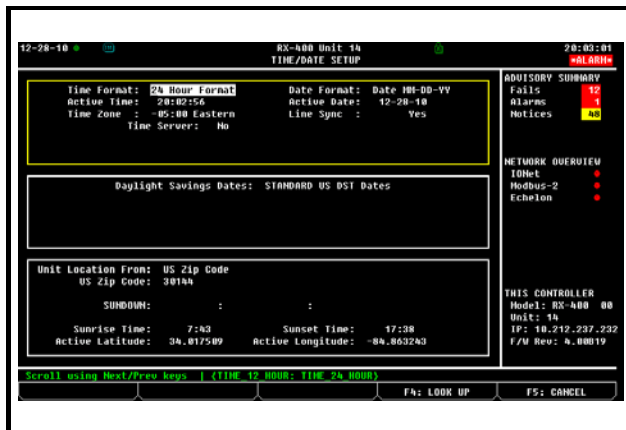

Figure 10-15 - Time/Date Setup Screen (User-Defined Shown)

10.8.1 Setting the Time and Date

The Time Format field affects how times are displayed and entered throughout the controller. When 24 Hour Format is selected in this field, the hours are displayed and entered as a number from 0 to 23. When 12 Hour Format is selected, the hours are displayed and entered as a number from 1 to 12; an A or a P at the end of the time signifies whether the time is A.M. or P.M.

Table 10-6 shows some times as how they would appear in both formats.

Time	12 Hour Format	24 Hour Format
7:15 a.m.	7:15:00A	7:15:00
12:00 noon	12:00:00P	12:00:00
11:59 p.m.	11:59:00P	23:59:00
12:00 midnight	12:00:00A	0:00:00

Table 10-6 - Time Formats (12 and 24 hour)

To select a time format, select either 12 or 24 hour using the **F4** (LOOK UP) tab.

Active Date

The Active Date shows the current Julian date in the format that was chosen in the Date Format field. For security reasons, the Active Date cannot be set to a date earlier in time than the current date without assistance from Retail Solutions Technical Service (1-800-829-2724).

Active Time

The Active Time is the current time in the controller's internal clock. This time may be changed by entering the new time in the **Active Time** field.

When a new time is entered in the **Active Time** field, it is sent across the network and changed on all device clocks so that all devices can remain synchronized.

Time Zone

Time zone is where the time zone of the E2 is entered. Each time zone is represented by a time zone offset that corresponds to the amount each time zone must add or subtract from Greenwich Mean Time (GMT) to get the correct local time. Choose the time zone by using the **F4** (LOOK UP) tab.

Time Server

Set this field to Yes or No depending on whether you would like to use SNTP (simple network time protocol) for synchronizing the E2 clock.

SNTP ensures accurate synchronization to the milli-second of computer clock times. If the E2 time is off by 5 seconds or greater, the SNTP will update the E2 time if

enabled. When the E2 time is updated, an entry in Service Log is added.

If this field is set to No, the E2 clock will have to be set manually. If this field is set to Yes, SNTP support is used. Two SNTP servers are supported: Primary Time Server, and an optional Secondary Time Server.

Primary Time Server

The E2 will call up this primary server first to synchronize the E2 time. If the primary server fails to respond, the secondary server is used.

Enter the IP address or name of the first server the E2 should use to set the time (up to 40 characters).

Secondary Time Server

The E2 will use this secondary server if no response is received from the primary server, or if the primary server is invalid.

If desired, enter the IP address or name of the second server the E2 should use to set the time (up to 40 characters).

Date Format

Dates may be presented and entered in either of two ways: month-day-year format, and day-month-year format. Choose the most appropriate date format by using the **F4** (LOOK UP) tab.

Daylight Savings Dates

The Daylight Savings Dates type determines how the E2 will make date adjustments for daylight savings time. Use the **F4** (LOOK UP) tab to cycle through the options in each of the fields. There are four options:

- **STANDARD US DLT DATES** - the E2 will use the standard United States' method of determining Daylight savings time dates. The Daylight savings time will start on the Sunday of the second week of March every year, and will end on the Sunday of the first week of November (Note: these are the dates recently enacted by the U.S. Congress, which went into effect in 2007).
- **USER DEFINED DLT DATES** - when this option is chosen, the user can specify start and end times for daylight savings, including month, week, and day settings.
- **EUROPEAN UNION DLT DATES** - the European Union Daylight rules are the same as the Standard US DLT Dates, with the exception that one hour must be added to the time at 1:00AM (GMT), during the last Sunday in March.
- **DLT Not Used** - the E2 does not make any adjustments to Active Time for Daylight Savings Time.

Daylight Savings Time uses GMT

This setting is only visible when **Daylight Savings Dates** is set to **User Defined DLT Dates**. If set to **Yes**, **Daylight Savings Time uses GMT** calculates the time to change from GMT and the current time zone setting. For example, if the start time is at 1:00 AM, and the time zone is +200 GMT, the time change will occur at 3:00 AM local time. Defaults to **No**.

Unit Location From

Sunrise and sunset times are calculated based on either zip code or latitude/longitude. If **US Zip Code** is chosen in the **Unit Location From** field, enter the zip code in which the controller is located. If outside the United States, choose **Lat/Long** and enter the latitude and longitude values in which the controller is located. Once a value has been chosen, the controller is able to calculate the sunrise and sunset times. The Sunset output will turn ON at sunset, and OFF at sunrise and can be connected to a lighting circuit.

Sundown

Sundown is an output that calculates when the sun sets based on latitude and longitude, and is ON when the sun sets. The user will select the Board/Controller, Point/Application, and Input values from the **F4** (LOOK UP) menu for each field. (When a Lighting Schedule is configured to use Sundown information, the Lighting Schedule application automatically connects to the Sundown output.)

10.9 Set Up Modem

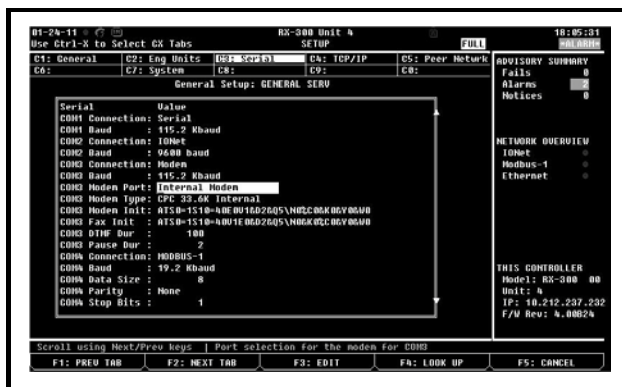

Figure 10-16 - Modem Select Screen

From the Main Menu:

1. Press **&7** (System Configuration)
2. Press **\$4** (Remote Communications)
3. Press **!1** (Modem Setup) to advance to the General Services screen

You can choose between an internal modem (one that is mounted directly on to the E2 circuit board (via the PC-104 slot in previous generation E2 circuit boards) or an external modem. If you have a modem, navigate to the **COM3 Modem Port** field and select **Internal Modem**. Press **F4** (LOOK UP) for the Option List Selection screen.

10.10 Set Up TCP/IP

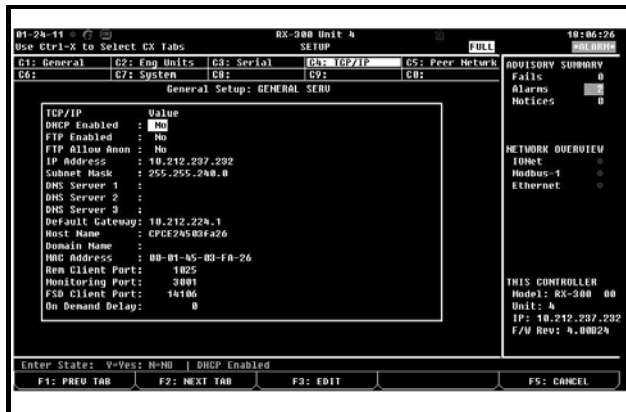

Figure 10-17 - TCP/IP Addressing

The TCP/IP screen is where you enter the information necessary to allow Ethernet connection to this controller. If this site uses Ethernet box-to-box, you will need to enter a TCP/IP address and a group name to allow all E2s on site to communicate as a group. See **Section 7, E2 Ethernet Peer Communications** for more information.

From the Main Menu:

1. Press **&7** (System Configuration)
2. Press **S4** (Remote Communications)
3. Press **#3** (TCP/IP Setup) to advance to the TCP/IP Setup screen

E2 units may be configured to communicate across an Ethernet computer network using TCP/IP protocol. To enable Ethernet communication, you will need to enter IP address information for the E2 in the Serial IP screen.

IP Address The IP Address field sets the network address for this E2. Other network devices (such as PCs running UltraSite) will communicate with this E2 by sending information to this specified address. Contact your network administrator to determine what IP address to enter.

The IP Address always consists of four numbers from zero to 255, each of which is separated by a period. Enter the address in this format.

Subnet Mask Contact your network administrator

to get the correct subnet mask value, and enter it in this field.

The default value, “255.255.255.0”, is the subnet mask commonly used for small networks.

Primary DNS Contact your network administrator to see if a Primary DNS value is required for this E2. If so, enter the Primary DNS address supplied by your administrator in this field. If not, leave this field set to “0.0.0.0”.

Secondary DNS Contact your network administrator to see if a Secondary DNS value is required for this E2. If so, enter the Secondary DNS address supplied by your administrator in this field. If not, leave this field set to “0.0.0.0”.

Primary Gateway Contact your network administrator to see if a Primary Gateway value is required for this E2. If so, enter the Primary Gateway address supplied by your administrator in this field. If not, leave this field set to “0.0.0.0”.

Secondary Gateway Contact your network administrator to see if a Secondary Gateway value is required for this E2. If so, enter the Secondary Gateway address supplied by your administrator in this field. If not, leave this field set to “0.0.0.0”.

DHCP Enabled Dynamic Host Communication Protocol (DHCP) is a protocol that assigns a dynamic IP address to devices on a network. With dynamic addressing, a device could have a different IP address every time it connects to the network. When set to **Yes**, DHCP Enabled keeps track of IP addresses and enables a new IP device to be added to a network without having to manually assign it a unique IP address. DHCP supports a mix of static and dynamic IP addresses.

10.11 Set Up Network Baud Rates



NOTE: If a baud rate is changed in this screen, the controller must be rebooted (turned OFF then ON again) to make the baud rate change occur.

10.11.1 COM1 Serial (RS232) Baud Rate

To access COM1 Serial (RS232) and I/O Network baud rates:

1. Press **Menu** to open the Main Menu
2. Press **7** (System Configuration)
3. Press **3** (System Information)
4. Press **1** (General Controller Info) and navigate to the **COM1** Baud rate field

The **COM1 Baud** rate field determines the speed of communications between the E2 and an RS232 device (such as a satellite link or PC).

The baud rate selected in this field should correspond with the baud rate for the RS232 device. For example, if connecting a PC to this port, the PC's COM port should be set up to communicate at the same rate as what is set in this field.

There are multiple options to choose from. Select one of the options below using **F4** (LOOK UP) depending on the type of connection.

- **1200 Baud** (devices that operate at 1200)
- **2400 Baud** (devices that operate at 2400)
- **4800 Baud** (devices that operate at 4800)
- **9600 Baud** (recommended for satellite)
- **19.2 Kbaud** (recommended for modem)
- **38.4 Kbaud** (recommended for modem)
- **57.6 Kbaud** (recommended for modem)
- **115.2 Kbaud** (recommended for direct connect)

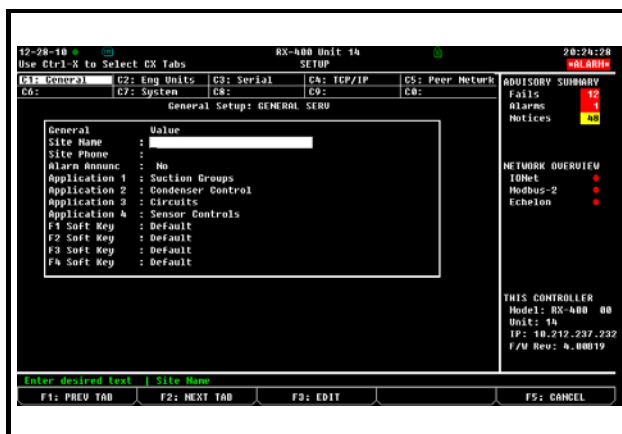

Figure 10-18 - COM1 Baud Rate Setup (Serial RS232)

10.11.2 I/O Network Baud Rate

The I/O Network baud rate is the rate at which the E2 will communicate with input and output boards on the RS485 I/O Network, and is located directly below the **RS232 Baud** rate field.

Press **F4** to select the baud rate. The appropriate baud rate is **9600 baud**.

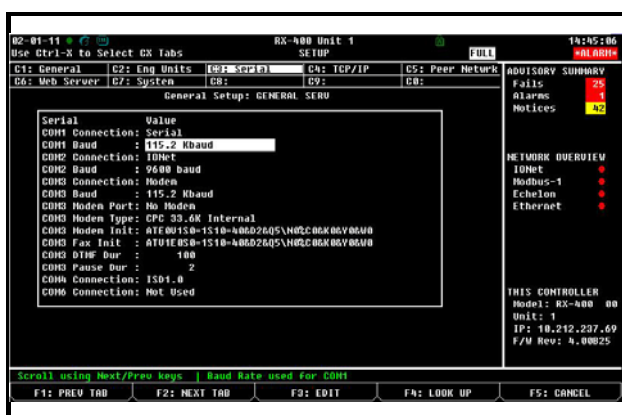

Figure 10-19 - I/O Network Baud Rate Setup

10.12 Set Up User Access

Access the User Access Setup screen from the System Information menu:

1. Press **Menu** to open the Main Menu
2. Press **7** (System Configuration)
3. Press **3** (System Information)

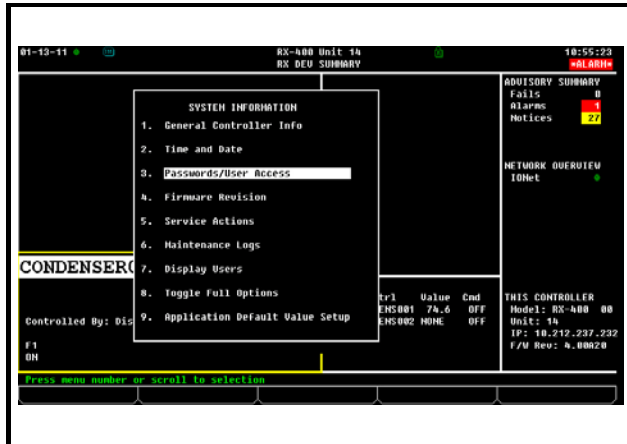

Figure 10-20 - System Information Menu

In the User Access Setup screen, you may add user names and passwords to the controller with varying levels of security, and customize user access for each security level.

To access this menu, choose option **3** (Passwords/User Access) from the System Information Menu.

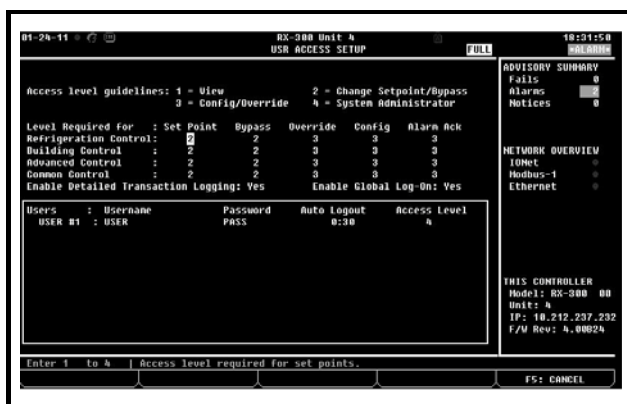

Figure 10-21 - User Access Setup Screen

An E2 may be programmed with up to 25 different users. A user basically consists of a username, a password, and an access level. Whenever a username and password are entered during login, the E2 searches the user records for the username and password. If found, the E2 will log

the user in at the access level chosen for the user in the user records.

The access level determines how many of the E2's features the user may use. The E2 uses four access levels, one being the lowest, and four being the highest. **Table 10-7** gives a description of each level and the capabilities they have access to.

Level 1	Read-only access. Users may generally only view status screens, setpoints, and some system settings.
Level 2	Setpoint and bypass access. Users may perform all the tasks a level 1 user may, plus they may change control setpoints and bypass some devices.
Level 3	Configuration and override access. Users may perform all the tasks a level 2 user may, plus they may override system settings, create new cells, and program new applications.
Level 4	System Administrator access. All E2 functions are accessible by a level 4 user.

Table 10-7 - User Access Levels

10.12.1 Changing Required User Access Levels

The **Level Required For** table in this screen is used to customize what access level is required to perform certain actions within the E2 unit. There are four rows in this table, each of which corresponds to a different type of E2 function or application.

- **Refrigeration Control** - This category includes changes or actions involving refrigeration applications specific to RX controllers (Suction Groups, Condensers, Circuits, CC-100s, etc.).
- **Building Control** - This category includes changes or actions involving building control applications specific to BX controllers (AHUs, Zones, Lighting Control, Time Schedule, Demand Control, etc.).
- **Common Control** - This category includes control applications common to both RX and BX controllers (Sensor Control, Time Schedules, Conversion Cells, Analog or Digital Combiners, Global Dataetc.).
- **Advanced Control** - This category includes applications common to both boxes that are only used by advanced users, such as Loop/Sequence Controllers, Refrigeration or HVAC Simulations, etc.

Each row has five columns, each of which corresponds to a different category of user actions.

- **Setpoint** - This includes all actions that change application setpoints. Also, **clearing** one or more alarms out of the Alarm Advisory Log is considered a “setpoint” action (refer to **Section 12.10.8.3, Clearing**, for the definition of “clearing alarms”).
- **Bypass** - This includes all actions that bypass a device to a certain state, such as initiating a manual defrost, or configuring an application input designated as a “bypass.” Also, **resetting** one or more alarms in the Alarm Advisory Log is considered a “bypass” operation (refer to **Section 12.10.8.2, Resetting**, for the definition of “resetting alarms”).
- **Override** - This includes any user-ordered override of a setpoint, input, or output.
- **Config** - This includes all actions that change an application setting. This includes configuring inputs and outputs.
- **Alarm Ack** - This includes **acknowledging** one or more alarms in the Alarm Log. If this field is set to 1, alarms can be acknowledged on the Alarm Advisory Log without a user logging into the controller first. If set to 2, 3, or 4, login is required before a user can acknowledge alarms. The default is set to 3

(controller login required for acknowledging alarms). Refer to **Section 12.10.8.1, Acknowledging**, for the definition of “acknowledging alarms.”

For each row and column of the Level Required For table, enter the desired minimum priority level that will be required for users to perform actions on each type of application. E2 will check this table when a user attempts an action to verify the user has the appropriate access level to make the change. If the user’s access level is equal to or above the priority setting in the table, access will be allowed. If not, access will be denied.

10.12.2 Creating a New User Account

After entering the User Access Setup screen by pressing **#3 Passwords/User Access** from the System Information menu:

1. Move the cursor so that it is somewhere in the **Users** box at the bottom of the screen.
2. Press **F1** (ADD USER) to put a blank record at the bottom of the list.
3. Type in the user name (**Username**), and then move to the next field (**Password**) by pressing the right arrow button.
4. Type in a password for the next user, then press the right arrow button to advance to the next field.
5. The Auto Logout feature determines the maximum time user may be inactive before being logged out. Enter the amount of time for the user and press the right arrow button.
6. Enter the appropriate access level for the user. See **Table 10-7**.
7. Press **BACK**.

10.12.3 Deleting a User

To delete a user from the system:

1. Move the cursor so that it is highlighting the record to delete in the **Users** box at the bottom of the screen, and press **F2** (DELETE USER).
2. A question box will appear to double check the deletion of the current record. Press **Y** if you are sure about the deletion.

10.13 Set Up I/O Network

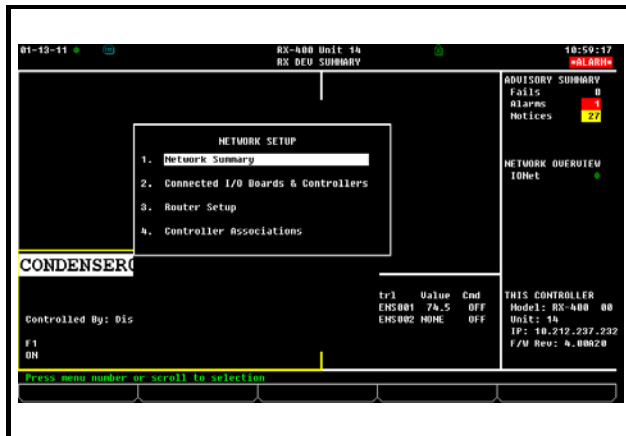

Figure 10-22 - Network Setup Menu

To start the setup on the I/O Network, access the Network Setup menu:

1. Press **Menu** to open the Main Menu
2. Press **& 7** (System Configuration)
3. Press **& 7** (Network Setup)

The Network Setup menu displays four options:

- Network Summary
- Connected I/O Boards & Controllers
- Router Setup
- Controller Associations

For the total (E2) devices online or offline, status, setup screens, changing board or controller names, configuring and commissioning devices, deleting a device, and viewing detailed status screens of controllers, select **Network Summary**.

For the number of I/O Network devices (16AIs, 8ROs, etc.) associated with each controller online and offline, select **Connected I/O Boards & Controllers**.

To set up a router, select **Router Setup**. For more information on routers and repeaters, refer to the *Router and Repeater Installation Guide (P/N 026-1605)*.

For CC-100 circuit associations, select **Controller Associations**.

10.13.1 Specify Number of Boards

Specify the number of boards from the Connected I/O screen:

1. Press **Menu** to open the Main Menu
2. Press **& 7** (System Configuration)

3. Press **& 7** (Network Setup)
4. Press **@ 2** (Connected I/O Boards & Controllers)

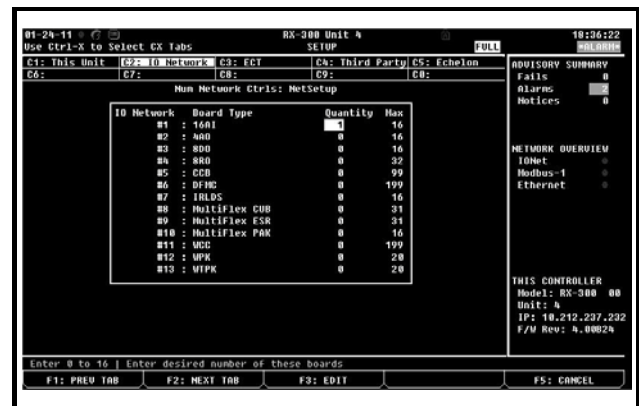

Figure 10-23 - Connected I/O Screen (RX version)

Boards on the I/O Network

16AI Boards Enter the number of 16AI analog input boards on this E2's I/O Network.

8RO Boards Enter the number of 8RO relay output boards on this E2's I/O Network.

8DO Boards Enter the number of 8DO digital output boards on this E2's I/O Network.

4AO Boards Enter the number of 4AO analog output boards on this E2's I/O Network.

IRLDS Controllers Enter the number of leak detector units on this E2's I/O Network.

(Options will vary depending on the type of controller used.)

10.13.2 Checking Online Status

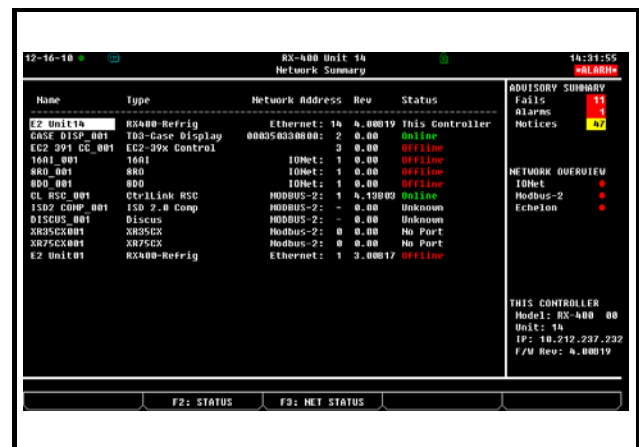





Figure 10-24 - Network Summary Screen

You can check all boards that are on either the Echelon Network (E2 controllers) or the I/O Network from the Net-

work Status screen (See *Figure 10-24*). The Network Summary screen displays information such as the Subnet and Node addresses for each board, and the status of Echelon and I/O boards.

To get to the Network Summary Screen:

1. Press  to open the Main Menu
2. Press  (System Configuration)
3. Press  (Network Setup)
4. Press  (Network Summary)





From the Network Summary screen you can see the total (E2) devices online or offline, status, setup screens, change board or controller names, configure and commission devices, delete a device, and view detailed status screens of controllers.

After determining if a board is offline, turn to *Appendix E: Troubleshooting*.

10.14 Set Up Echelon Network

10.14.1 Specifying Number of Devices

To specify the number of devices on the Echelon Network, navigate to the Connected I/O screen:

1. Press  to open the Main Menu
2. Press  (System Configuration)
3. Press  (Network Setup)
4. Press  (Connected I/O Boards & Controllers)

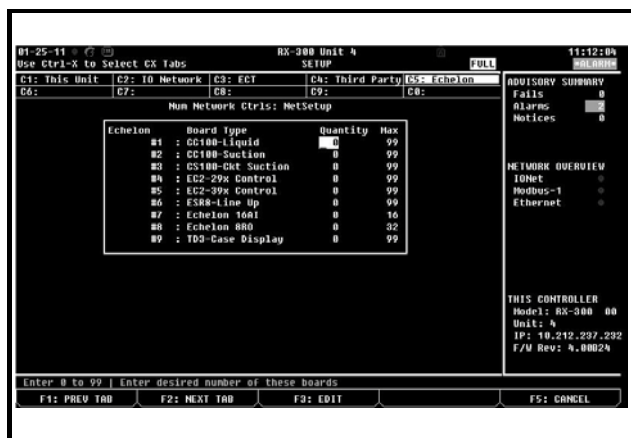

Figure 10-25 - Connected I/O Screen (RX version shown)

After logging in for the first time, the Connected I/O screen will ask you to specify how many of each type of device will be connected to the E2 you are currently programming. (Options will vary depending on the type of controller used.)

Unit Number (Echelon Subnet) Each E2 on the Echelon Network must have a different unit number. This can be any number from 1 to 255, but each E2's number must be unique. No two E2s on the network may have the same unit number.

Enter this number in the Unit Number field. It is recommended you number the first E2 "1" and number the other E2s on the network sequentially (2, 3, 4, etc.).

Unit Name Type a name for the E2 in the Unit Name field.

Unit Controllers (Echelon)

Liquid Ctrls (CC100P/CC100LS) Enter the combined number of pulse valve case controllers (CC100Ps) and liquid-side stepper valve case controllers (CC100LSs) in this field.

Suction Controllers (CC100H) Enter the number of suction stepper case controllers (CC100Hs) in this field.

Circuit Suction (CS100) Enter the number of suction lineup circuit controllers (CS100s) in this field.

ESR8 Line Up Boards Enter the number of ESR suction lineup circuit boards (SR100s) in this field.

TD3 Temperature Displays Enter the number of TD3 temperature display units in this field.

EC2-29x Case Controllers Enter the number of EC2-29x refrigerated case controllers in this field.

EC2-39x Case Controllers Enter the number of EC2-39x refrigerated case controllers in this field.

Echelon 16AI Enter the number of 16AIe analog input boards in this field.

Echelon 8RO Enter the number of 8ROe analog input boards in this field.

10.14.2 Commissioning a Device

Once all records have been created and defined for all devices on the Echelon Network, they must be "commissioned." Commissioning is necessary for the E2 to identify and establish communications with all devices on the network.

To start commissioning, open the Network Summary screen:

1. Press  to open the Main Menu

2. Press **F7** (System Configuration)
3. Press **F7** (Network Setup)
4. Press **F1** (Network Summary)

Name	Type	Network Address	Rev	Status
E2 Unit14	RS485-Retrig	Ethernet: 14	A.00019	This Controller
EC2 DISP.001	T03-Case Display	00050330000	2	0.00 Online
EC2 391 CC.001	EC2-39X Control		0	0.00 Offline
T001.001	T001	IONet:	1	0.00 Offline
SR0.001	SR0	IONet:	1	0.00 Offline
SR0.001	SR0	IONet:	1	0.00 Offline
CL RSC.001	CtrlLink RSC	MODBUS-2:	1	A.10003 Online
ISD2 EOP.001	ISD 2.0 Comp	MODBUS-2:	-	0.00 Unknown
DISCUS.001	Discus	MODBUS-2:	-	0.00 Unknown
XR35CX001	XR35CX	Modbus-2:	0	0.00 No Port
XR35CX001	XR35CX	Modbus-2:	0	0.00 No Port
E2 Unit01	RS485-Retrig	Ethernet: 1	3.00017	Offline

Figure 10-26 - Network Summary Screen

NOTE: A device may only be commissioned if it is properly connected on the network and powered up.

How Echelon Commissioning Works

Each device that is capable of communicating on a Echelon Network has a unique 12-digit “Neuron ID” code number that is hard-coded in a chip on the board. In order for the E2 to begin communications with a unit controller or another E2, it must know the device’s ID number.

When a device is commissioned, its 12-digit code is either entered by hand into the E2 (via the front panel keyboard) or sent across the network to the E2 using the device’s service button. Once the E2 knows the device’s 12-digit ID, it establishes communication and gives the device its user-defined subnet and node address. From that point on, the E2 uses only the subnet and node address to communicate with the device.

As mentioned above, there are two ways in which a device may be commissioned. No one way is better than the other in terms of effectiveness, but one of the methods may be less difficult than the other depending on the type of installation.

MODBUS Commissioning

If commissioning a MODBUS device and multiple MODBUS ports are available, you will be prompted to select the appropriate network during the commissioning process.

10.14.2.1 The Service Button Method

To commission a device using the service button, you must first set up the E2 to receive a service button signal, and then press the service button on the device. When the signal is received by the E2, the device will be commissioned.

To set up the E2 to receive a service button signal, move the cursor to the Controller Name field of the record you wish to set up, and press **F4** (SET ADDRESS).

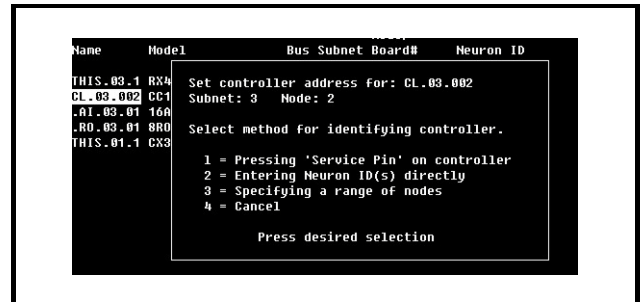

Figure 10-27 - Commissioning Menu

A menu will appear on the screen, giving you the option of either pressing the service button, entering the Neuron ID by hand, or canceling and returning to the main screen. Press **F1** to select the service button option.



Figure 10-28 - Service Button Screen

The E2 will prompt you to enter a wait time in the Wait Time field. The Wait Time is the amount of time the E2 will try to detect a service button press before declaring the attempt unsuccessful and returning to the main screen. To commission the device, the Neuron ID must be sent during the Wait Time duration.

After you enter a wait time in hours:minutes:seconds format and press **Enter**, the Wait Time duration begins. All that is left to do is to press the service button on the device to be commissioned.



CAUTION: When the E2's Wait Time duration begins, the E2 will accept the first Neuron ID code it receives. Be sure that no other service buttons on any devices on the network are being pressed during the Wait Time. Since the service button on the CC-100 is its Hand-held Terminal jack, be sure that no one has a Hand-held Terminal plugged into a CC-100 other than the one being commissioned.

The location of the service button and the method of pressing it depends on the device or controller being commissioned.

The CC-100's Service Button

Since the CC-100 is meant to remain in an enclosure, the CC100's Hand-Held Terminal jack has been configured to act as the service button. Plugging a Hand-Held Terminal into the jack simulates a service button press.

The Hand-Held Terminal Jack is on the left side of the case controller next to the power cable harness connection. To send the Neuron ID, plug a Hand-Held Terminal into the jack and hold it in for five seconds.

The TD3's Service Button

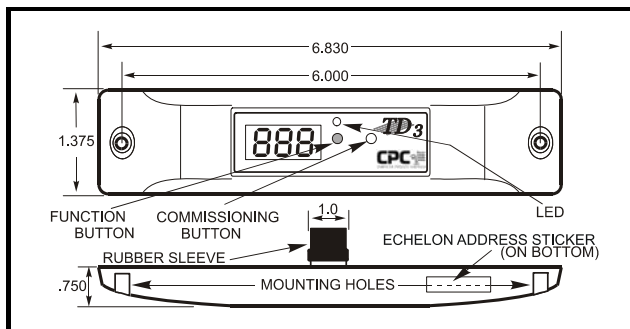

Figure 10-29 - TD3 Service Button Location

The service button on the TD3 is located on the front panel (**Figure 10-29**). Of the two buttons on the face, the commissioning button is the one on the right. To send the Neuron ID, press and hold this button down for five seconds.

The ESR8's Service Button

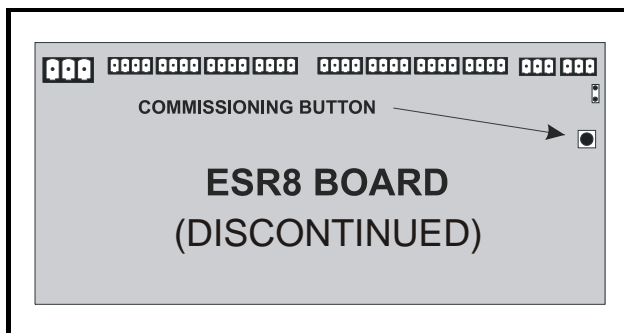

Figure 10-30 - ESR8 Service Button Location

The service button on the ESR8 is located on the right hand side of the board directly below the termination jumper (**Figure 10-30**). To send the Neuron ID, press and hold this button down for five seconds.

Commissioning the EC-2

The EC-2 can be commissioned by pressing the UP ARROW key on the EC-2 front panel and holding it for five seconds.

10.14.2.2 The Manual ID Entry Method

The Manual ID Entry Method involves entering each device's twelve-digit ID number by hand. When entered, the E2 searches the network and tries to match the ID number to the device. When the E2 finds this device, the commissioning process is completed.

The easiest way to set up a multiple-node store using the Manual ID Entry Method is to arrange all network devices into a list that shows each device's name, subnet and node address, controller type, and corresponding Neuron ID number. Once this list is complete, each device may be commissioned one at a time from the E2 front panel.

To make a list of network devices, follow the steps below:

1. For each record set up in the Controller Network Configuration/Status Screen, write down the contents of each device's Controller Name, Model, Subnet, and Node fields on a sheet of paper. If desired, you may also include the model or serial numbers of the units that will be controlled, as well as a physical location.
2. When step 1 is complete, go to where each device on the list is installed and locate each device's Neuron ID sticker. Every Echelon-compatible device available from Retail Solutions has a sticker on its enclosure that shows the unit's Neuron ID number. Each sticker also has a perforated

tag at the bottom that may be removed and affixed to your form. Tear this tag off and stick it in the Neuron ID blank on the sheet of paper. If the perforated tag has already been removed, write the ID number in the blank.

When all Neuron ID numbers have been collected, return to the E2 and enter the Neuron ID numbers for each device. To commission a device, move the cursor to the device to be commissioned and press **F4** (Set Address).

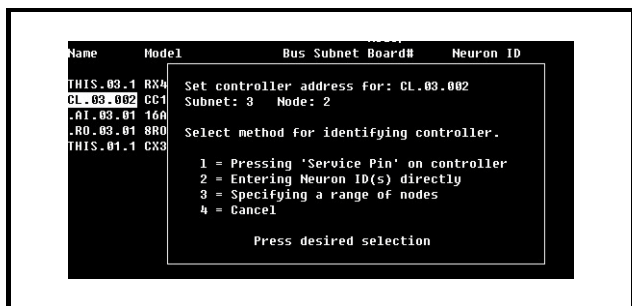

Figure 10-31 - Commissioning Menu

A menu will appear on the screen, giving you the option of either pressing the service button, entering the Neuron ID by hand, or cancelling and returning to the main screen. Press **2** to select the manual entry option and bring up the dialog box shown in *Figure 10-32*.

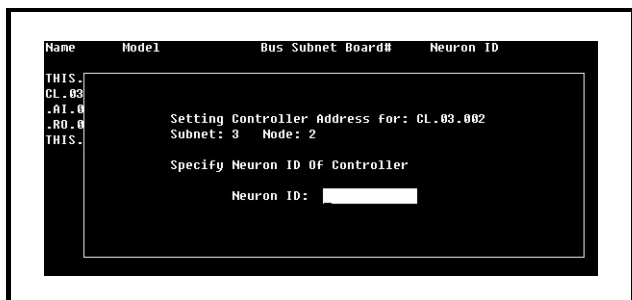

Figure 10-32 - Setting Controller Address - Neuron ID

Enter the device's Neuron ID as it appears on the form you created, and press **Enter**. The E2 will then look for the controller with the Neuron ID you entered. If it is found, the E2 commissions the device, and you may move on to commissioning the next device.

If E2 does not find it, the display will read "ERROR - Controller with specified Neuron ID did not respond." This could be caused by an improperly entered number, or it could be caused by a problem with the device's network connections or power connections.

When all devices are commissioned, keep the form with the Neuron ID stickers in an easily accessible place so that it may be referred to if necessary for board removals, replacements, or troubleshooting.

10.15 License Management

Some applications in the E2 are only available when activated with a license key that is obtained through Retail Solutions. Licensing allows the user to activate certain features in the E2.

To obtain a license for a feature, go to the TCP/IP setup screen and obtain your E2 controller's MAC Address. Press **Alt** + T, or from the Main Menu:

1. Press **&7** (System Configuration)
2. Press **S4** (Remote Communications)
3. Press **#3** (TCP/IP Setup) to open the TCP/IP Setup screen and locate your E2's MAC address (circled in *Figure 10-33*):

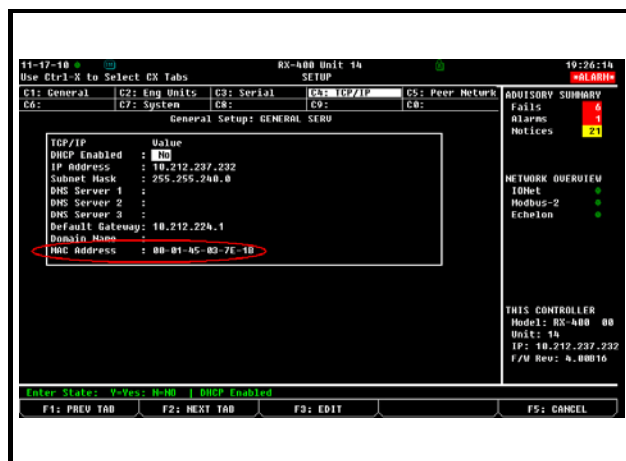

Figure 10-33 - TCP/IP Screen - Locating the Mac Address

4. Call Retail Solutions Customer Service at 770-425-2724 and have your MAC Address ready in order to obtain your unique license key.

Once you have received your unique license key from Customer Service, you can now activate the licensed feature(s) from the License Report screen. The License Report screen displays that E2 controller's unit type and firmware version, the list of all licensed features on that E2, the current number and maximum number of each of those applications allowed, and which additional features, (that require a license key), have been enabled.

From the Main Menu:

1. Press **&7** (System Configuration)
2. Press **S9** (Licensing)
3. Press **F1** (Add Feature)

Enter your license key to activate the desired feature:

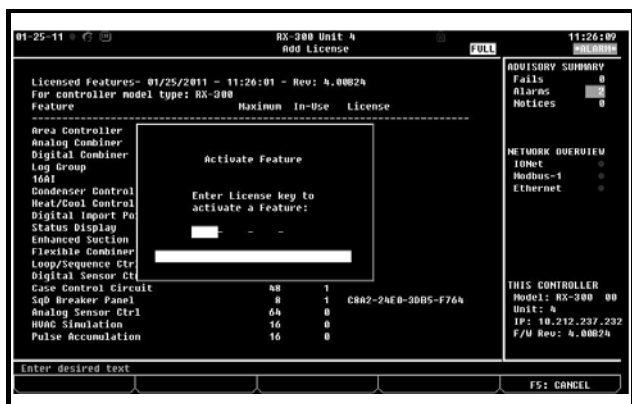

Figure 10-34 - Enter Your Unique License Key

4. Reboot the controller and open the License Report screen again to see the license key appear next to the activated feature (Figure 10-35):

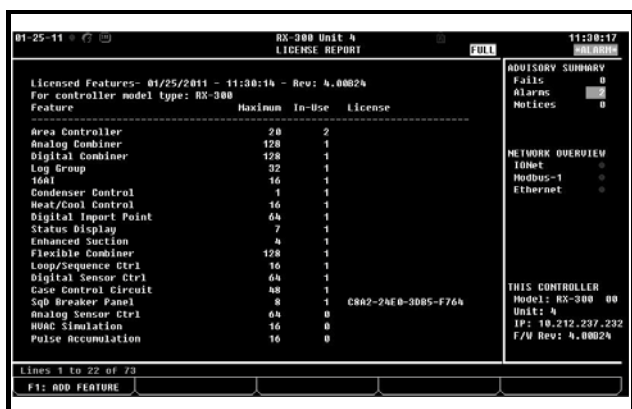

Figure 10-35 - License Report Screen

10.15.1 Web Services

Web Services is a licensed feature that allows the user, once the required license has been obtained and entered, to view and adjust certain parameters in the E2 controller through a Web page. The E2 Web Services feature enables the user to:

- View site-specific information such as site name, site phone, local date and time.
- View the current version of the E2. This includes the type of unit (e.g., RX-400) and the version of the firmware.
- View global data values such as outside air temperature and humidity.
- View a list of other networked area controllers at the site, including version and controller type information.

tion.

- Connect to the selected E2 for remote configuration changes.
- Access Terminal Mode.
- View Alarms.

To access Web Services:

Open a browser window and enter the IP Address of your E2 controller:



Figure 10-36 - E2 Web Services Page

10.16 Set Up Alarming

To set up alarms, open the Alarm Setup menu:

1. Press **Menu** to open the Main Menu
2. Press **& 7** (System Configuration)
3. Press **% 5** (Alarm Setup)

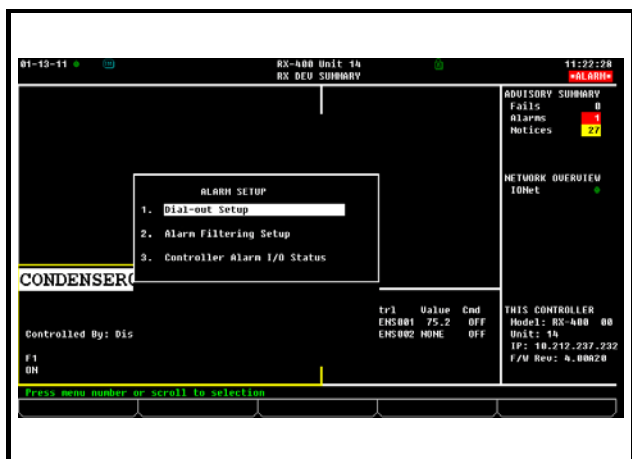

Figure 10-37 - Alarm Setup Menu

10.16.1 Specifying Alarm Reporting Types

Apart from storing alarms it generates in its own Alarm Advisory Log, E2 can also report alarms it generates or receives in order to notify personnel. E2 can report alarms in several different ways.

10.16.1.1 The Display Line

Alarms that occur within an E2 (or which are received by an Alarm Annunciator from another E2) may be reported to the header display at the top of the screen. When an alarm is reported to the display, the word “*ALARM*” flashes underneath the time at the top of the screen, allowing site managers or supervisors to see that one or more alarms are active for the E2.

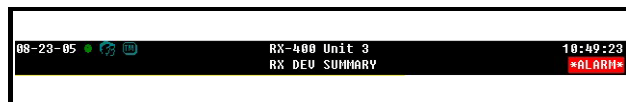

Figure 10-38 - Display Line

10.16.1.2 The Alarm Output

Each E2 has a single digital output that reacts to alarm reports. An alarm can be reported to this output, in which case the output turns ON and remains on until the alarm condition has returned to normal.

10.16.1.3 Dial-Out

Alarms may be sent to remote alarm receivers via the modem defined for the controller. Possible dial-out devices include a PC running UltraSite, a printer, a fax machine, and a digital pager. Dial-out sites are configured in Section 10.16.3.

10.16.1.4 The Echelon Network (The Alarm Annunciator)

If multiple E2s exist on a network, you may choose to send alarms from all E2s across the Echelon Network so that they may be picked up by the Alarm Annunciator.

The Alarm Annunciator is the primary alarm reporting device in a multiple-device E2 Network. The Alarm Annunciator gathers all alarms posted by all devices on the Echelon Network, records them in its own advisory log, and applies its own set of alarm filters to determine if the alarms should be dialed out, reported to its display, or sent to its Advisory Output.

There are several benefits to having an Alarm Annunciator:

- An Alarm Annunciator makes it possible to handle all alarm dial-outs for all controllers with a single modem or network card.

- Users can view alarm notifications and alarm logs for all controllers from the Alarm Annunciator.
- Only the Alarm Annunciator needs to be programmed with alarm filter settings for dial-out, output, and display. All other controllers may be programmed to simply send all alarms to the Alarm Master via the LonWorks Network.

10.16.2 Setting up an E2 to be an Alarm Annunciator

Any E2 on the network that has a modem or Ethernet connection can be set up as an alarm annunciator, but only one alarm annunciator per network is allowed. To set up from the Main Menu:

1. Press **&7** (System Configuration)
2. Press **#3** (System Information)
3. Press **!1** (General Controller Info)
4. Set **Alarm Annunc** field to **Yes**.



NOTE: When the E2 is set up as an Alarm Annunciator, the Home screen becomes the Alarm Log.

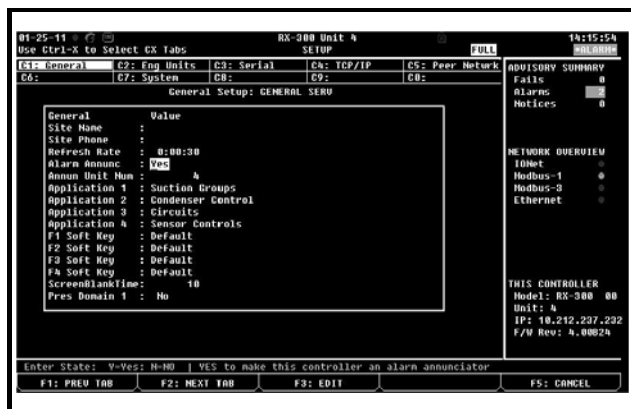

Figure 10-39 - Alarm Annunciator

10.16.3 Alarm Dial-Out

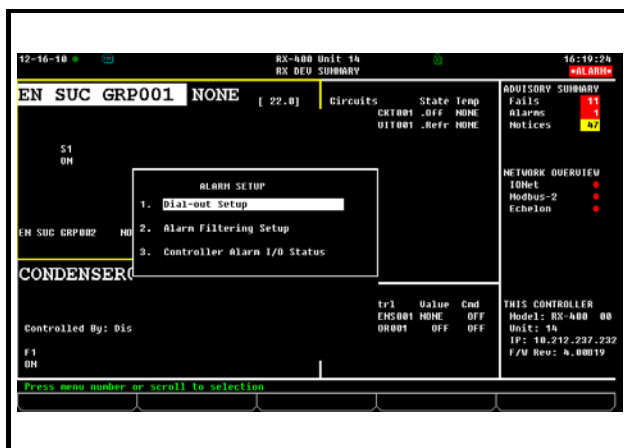

Figure 10-40 - Alarm Setup Menu

One of the E2's most important alarm reporting features is its ability to dial-out to remote sites whenever a serious alarm condition occurs. Each E2 is capable of dialing out to up to three sites. The E2 may dial out to a computer, a fax machine, a digital pager, or a printer. To set up from the Main Menu:

Dial-out devices are set up in the Dial-out Setup screen. To reach this screen:

1. Press **Menu** (Main Menu)
2. Press **&7** (System Configuration)
3. Press **%5** (Alarm Setup)
4. Press **!1** (Dial-out Setup)

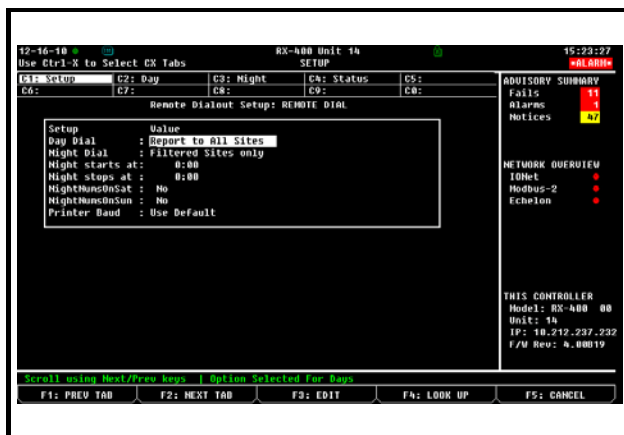

Figure 10-41 - Remote Dialout Setup Screen

This screen and the other screens that follow it are used to set up dial-out sites for both daytime and nighttime operation, including specifying phone numbers and IP addresses. Use the **F1** and **F2** keys to cycle through the Setup screens.

10.16.4 Introduction: Alarm Reporting

In general, a controller reports alarms to any or all of four different sources:

1. The E2 Display Header

Alarms that occur within a E2 may be reported to the header display at the top of the screen. When an alarm is reported to the display, the word “*ALARM*” flashes underneath the time at the top of the screen, as shown in the example below:

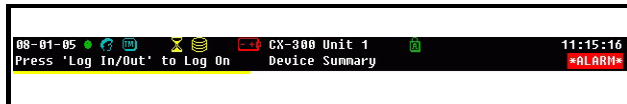

Figure 10-42 - E2 RX Display Header

2. The Advisory Output

Each E2 has a single digital output that reacts to alarm reports. When an alarm is reported to this output, the output turns ON and remains on until the alarm condition has returned to normal.

3. Dial-Out

Alarms may be sent to remote alarm receivers via the modem defined for the controller. Possible dial-out devices include a PC running UltraSite, a printer, a fax machine, and a digital pager.

4. The LonWorks Network (The Alarm Annunciator)

If multiple E2s exist on a network, you may choose to send alarms across the LonWorks Network so that they may be picked up by the Alarm Annunciator.

Refer to **Section 10.16.2** for information on how an Alarm Annunciator works.

10.17 Set Up Global Data

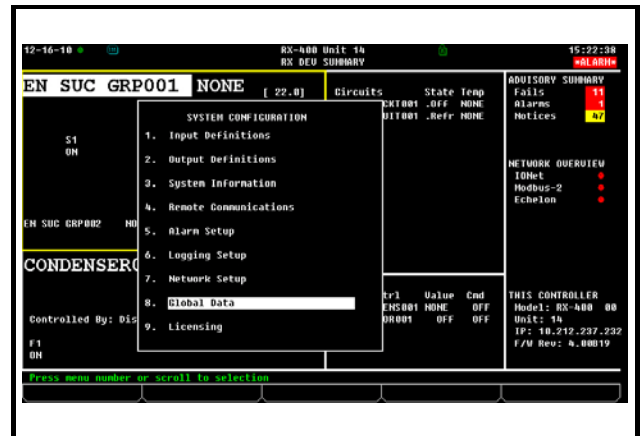

Figure 10-43 - System Configuration Menu

In a network with multiple E2s, it is often the case that certain sensors or transducer values will need to be used by all E2s. A good example of this is outside air temperature. There is no real need for every E2 to have its own outside air temperature sensor, and therefore it would be beneficial if a single sensor could be used by all E2s on the network.

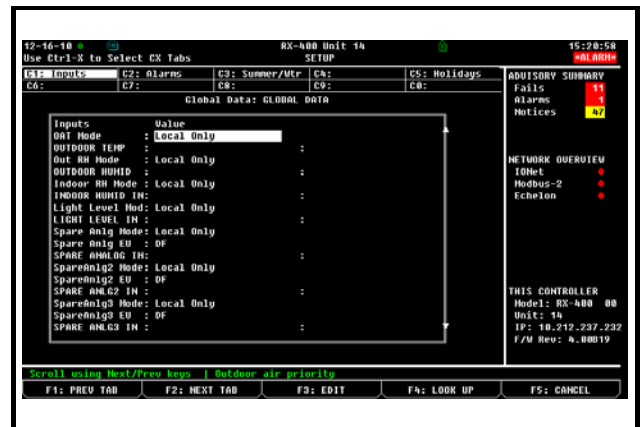

Figure 10-44 - Global Data Setup Screen

Navigate to the Global Data screen from the Main Menu:

1. Press **&7** (System Configuration)
2. Press ***8** (Global Data) to open the Global Data Status screen.
3. Press **F5** (Setup) to open the Global Data Setup screen.

The Global Data feature is an enhanced method of effectively distributing commonly used input values between multiple E2s. Sensors such as outdoor temperature and outdoor humidity are set up on an E2 as Global Data inputs. This E2 then becomes the “provider” of the

global sensor values to all other Global Data applications on the E2.

As a result, a single sensor can be used by any application in any E2 on the network.

Unless you program it otherwise, the E2 always assumes you will be using Global Data in all your applications. When you create new applications in the E2, it will always automatically connect the appropriate application inputs (except for the spares) to their corresponding Global Data outputs.

10.17.1 Priority Settings

When selecting the priority for a global sensor input, there are four settings to choose from.

Primary Primary inputs are the highest priority inputs. If a sensor is set up with a primary priority, it is recognized by all Global Data applications on the network as the highest priority. The primary provider sends this input value to the other Global Data applications in the other E2s, and each E2 immediately sends that value to all of its own applications that use the Global Data input.

Only one input of each type may be designated as a primary on the E2 Network. In other words, if one E2 is acting as the primary provider of the global Outdoor Air Temp, no other E2 on the network may have a global Outdoor Air Temp sensor with a “primary” priority.

If using this priority setting, you must enter board and point settings.

Secondary Sensors that are set up with secondary priorities are backup sensors that will be used by all Global Data applications if the primary sensor fails.

If a global input is set up on an E2 with a secondary priority, the E2 will not send its value to the other Global Data applications as long as it is receiving a primary value of that type from another E2 on the network. If a secondary provider does not receive a primary value update at least once every five minutes, the secondary provider will assume the primary sensor has failed, and it will send the secondary value to all other Global Data applications on the network. These applications will then use the secondary value in place of the failed primary value.

Secondary providers will continue to send the input value until the primary provider again sends a valid update to the other Global Data applications. The secondary provider would then stop sending the secondary value, and all Global Data applications would use the primary value.

If using this priority setting, you must enter board and

point settings.

Example: Out of three E2s, an outside air temperature sensor on E2 A’s I/O Network is set up as the primary provider of the global Outside Air Temp input. A similar sensor is set up on E2 C with a secondary priority (see **Figure 10-45**).

As long as E2 A is capable of broadcasting a valid temperature value, all three E2s would use E2 A’s Outside Air Temperature value in their own Global Data applications.

However, if E2 A loses contact with the sensor, E2 A no longer has a valid temperature value to send to the other Global Data applications. After five minutes of no updates from E2 A, E2 C will consider the primary Outside Air Temp source to have failed, and it will begin sending the value of the secondary sensor to the Global Data applications of the other two E2s. All E2s would then use this secondary value as Outside Air Temperature.

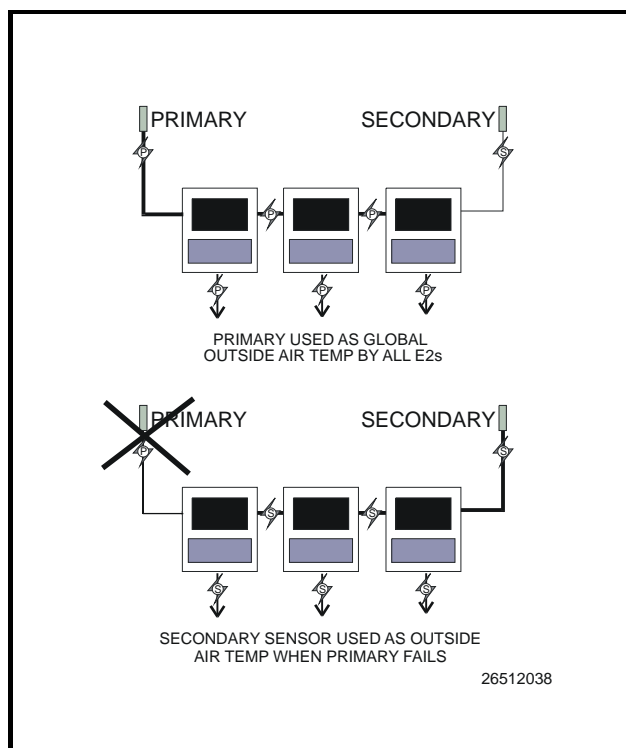

Figure 10-45 - Global Data Priority Example

Just as there may be only one primary provider for each input type, there may be only one secondary for each input type. It is recommended that secondaries be set up on different E2s than primaries; this way, if a single controller fails or loses communication with the other E2s, there will still be a usable input source for the other E2s.

User This setting means the E2's global data will read (or be a "User" of) all values coming from the network. This setting is for E2s that are not connected to the sensor itself, but read the data that comes from it.

If the application in this E2 will be using primary or secondary inputs from other E2s, then set the priority to "USER."

Local Only This setting specifies that the input to the global data is read and sent only to within the E2 you are programming. Also, this means that this E2 will not read any Primary or Secondary providers from the network.

If using this priority setting, you must enter board and point settings.

Example: Setting Up an Outdoor Temperature Sensor

1. Press ***8** (Global Data) and the Status screen opens.
2. Move the cursor to the Outdoor Air Temperature (OAT) Mode, and then choose the priority by scrolling with the **Next**, **Prev** keys.
3. Press the down arrow button once to the Board and Point section and enter the board and point locations for the sensor.
4. Press **←** (BACK) to return to the Main Status (Home) screen.

The Outdoor Air Temperature sensor is now set up as a global device in the E2. Other global inputs can be set up using the same method as above.

E2 is now ready to be programmed with applications.

10.18 Set Up Applications

From the Main Status (Home) screen, place the cursor on the application you wish to view and press **F5** (SETUP). You can also press **←** and select **5** (Setup) from the Actions Menu to open the Setup screen for your selected application.

10.18.1 Add/Delete an Application

Add an Application:

1. Press the **Menu** key to open the Main Menu screen.
2. Select **6** (Add/Delete Application) to open the Add/Delete Application menu.
3. Select **1** to add an application.

4. Choose an application by pressing **F4** (LOOK UP) to open the Option List Selection menu, and choose the application you wish to add.
5. Press **Enter** to place the application in the **Type** field.
6. Select the number of applications you wish to add in the **How many?** field.
7. Press **Enter** to add.
8. You are then asked if you would like to edit the application now. Press **Y** (Yes) or **N** (No).

Delete an Application:

1. Press the **Menu** key to open the Main Menu screen.
2. Select **6** (Add/Delete Application) to open the Add/Delete Application menu.
3. Select **2** (Delete Application).
4. Press **Enter** to delete the application if not displayed by default.
5. If not displayed by default, choose the application you wish to delete by selecting **F4** (LOOK UP). The Option List Selection menu opens. Choose the application you wish to delete from this list.
6. Press **Enter** and the application appears in the **Type** field.
7. Press **Enter** to delete the application.
8. A dialog box opens asking if you are sure you want to delete the application you have selected. Press **Y** (Yes) or **N** (No).

10.18.2 Using and Configuring a Setup Screen

The Setup screen is application-specific depending on where you place the cursor on the Home screen.

Press **←** to open the Actions Menu and select **5** (Setup), or press **F5** (SETUP) on the Home screen.

The Setup screen for your selected application will open.

10.18.2.1 The Edit Menu

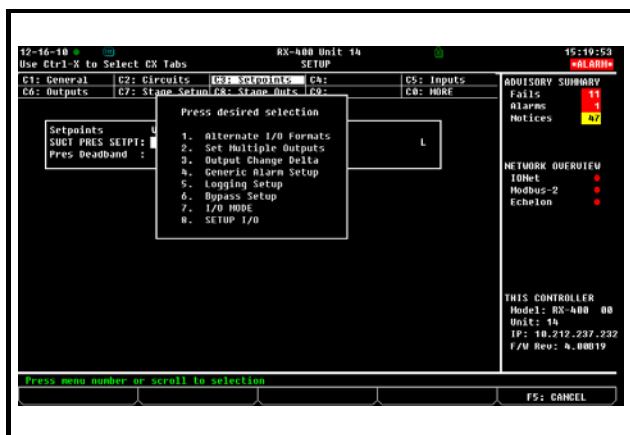

Figure 10-46 - Edit Menu

The Edit menu becomes available when you are on a Setup screen and can be opened by pressing **F3** (EDIT). Depending on which Setup option (index tabs) is highlighted, the Edit menu allows you to change field formatting using these options:

- Alternate I/O Formats - setting up pointers can change a field to expect a **Board:Point, Fixed Value**, or **Area Ctrl:Application:Property**.
- Set Multiple Outputs - allows you to connect an output pointer to multiple input pointers.
- Output Change Delta - the +/- change that must occur at the output before the new value is used.
- Generic Alarm Setup - enables the user to custom-assign alarming parameters in the controller.
- Logging Setup - enables the user to turn logging on for a particular parameter. Note that if “L” appears next to the parameter, default logging has already been enabled for the Logging Group Cell.
- Bypass Setup - Opens screen for bypass input types, which are “Momentary” or “Level” triggered and remain active for a “Bypass Duration”. For example, Time Schedules have two such inputs.
- I/O Mode - toggles between displaying board names and board numbers.
- Setup I/O - allows user to enter an input or output point setup screen.

10.18.2.2 Entering Setpoints

An application setpoint is a user-defined control parameter stored inside the controller. Setpoints can be programmed from any application setup screen.

To enter setpoints from a Setup screen:

1. Press **F5** (SETUP) from the desired application’s Status screen. (If starting from the Home screen, move the cursor to the desired application’s value and press **Enter** to open the Actions Menu. Choose **Setup**. This will take you to the Setup screen.)
2. Once inside the application’s Setup screen, look for the **Setpoints** option in the index tabs along the top of the screen.
3. Use **F2** (NEXT TAB) to tab over and the Setpoints box of your application will open.

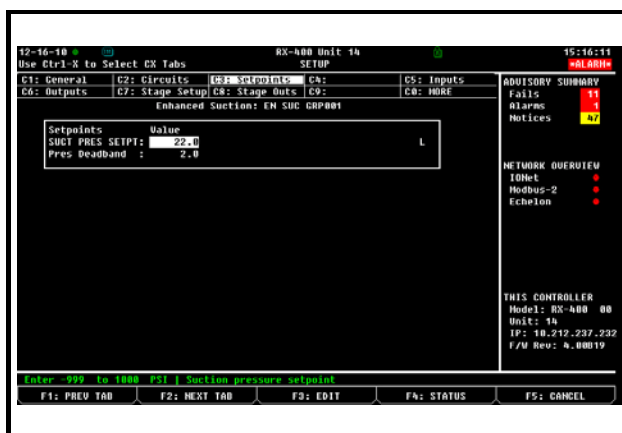

Figure 10-47 - Setpoints Box

10.18.2.3 Navigating the Setup Screen

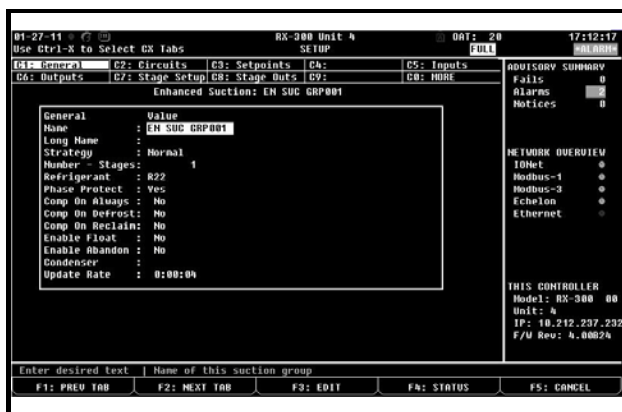

Figure 10-48 - Typical Setup Screen (RX version shown)

The Setup utility is the interface used to change settings and setpoints, and define inputs and outputs in the E2. *Figure 10-11* and *Figure 10-48* show a typical Setup screen and its primary elements.

Index Tabs

The ten boxes at the top of the screen labeled **C1** through **C0** are known as the **index tabs**. These tabs provide a short index of the screens that are used to set up the

current application. The numbers **C1** through **C0** represent the screen numbers (**C1** being screen 1, **C2** being screen 2, and so on).

Each of the Setup screens that you may access will have a name beside its number. But as in **Figure 10-11** and **Figure 10-48** for example, you will notice some tabs have names, while others are blank.

As you move through these screens within the Setup Editor, the highlight will move to different tabs to indicate which screen is being displayed.

- Pressing **F1** (PREV TAB) will back-up the order of the screens.
- Pressing **HOME** (HOME) at any point will take you to the Main Status (Home) screen.



TIP: To see each screen in a typical setup for the E2 RX controller, start from the Main Status (Home) screen.

1. Position the cursor somewhere inside the Suction Groups section and press **Enter** and **5** (Setup), or just **F5** (SETUP) from the Home screen. The General Setup screen will be displayed.
2. Press **F2** (NEXT TAB) to move the cursor to Setpoints. The Setpoints Setup screen is displayed.
3. Press **F2** again and the Inputs Setup screen comes up.
4. Press **F2** a few more times to see the rest of the Setup menu screens. When the **C0** tab (MORE) is highlighted, there may be more than one extra Setup screen. Press **Ctrl** + **0** (zero) to see a list of all Setup screens for that application.
5. Keep pressing **F2** while taking note of the extra screens until **C1** is highlighted once more.

These screens (**C1** through **C0**) contain all of the set up information that is associated with the selected suction group.

Blank tabs are inaccessible. There are several reasons why a tab may be inaccessible (i.e., without a name next to the number):

- The tab (and the corresponding screen) is unused and reserved for later revisions.
- The screen may only be accessed when running in

Full Options mode.

- The screen may require one or more fields to be set to certain values before the screen may be accessed. For example, a screen containing nothing but compressor proof input definitions might be hidden if there is a field on another screen that tells the system there are no proof checking devices on the group's compressors. To access this screen, you would have to set this field to "YES".

The screen you are currently in is always highlighted in the screen's index tab. For example, in **Figure 10-11** and **Figure 10-48**, because Screen 1 is displayed, tab **C1** is highlighted.

The Help Line

The line near the bottom of the screen above the function key menu is the **help line**. The help line this time provides a short description of the selected field, along with important information such as minimum and maximum value ranges, and setup instructions.

The Function Keys For Setup

The five boxes at the very bottom of the screen show the function of keys **F1** through **F5**. Most of these keys retain the same function no matter which field, screen, or application is selected in a Setup screen. **Table 10-8** shows what each key is used for.

Key	Function	Description
F1	PREV TAB	Moves backward one screen
F2	NEXT TAB	Moves forward one screen
F3	EDIT	Opens the Edit Menu box
F4	STATUS, OVERRIDE, or LOOKUP	Opens the Detailed Status screen, Opens the Override Update screen, or Look Up Tables
F5	CANCEL	Cancel the operation

Table 10-8 - Function Keys for Setup Screens

After all of the functions of E2 are set up, the next step is to set the System Configuration, which is basically how the system is used.

10.18.3 Using the Help Key to get Property Help

Property Help gives an explanation of the parameter, input, or output the user has selected.

Pressing the  key while the cursor is pointing to a parameter, input, or output opens the Property Help window. The Property Help window displays documentation specific to the parameter, input, or output the cursor is currently pointing to.

11 Software Overview

11.1 Suction Groups

11.1.1 Introduction

The E2 RX refrigeration controller uses suction group applications to cycle compressors in an effort to maintain a constant suction pressure or temperature in a refrigeration system. A suction group may contain up to 16 compressor stages (standard, variable-speed, or unloader).

There are two different types of suction group applications:

- *Suction Group* - The “standard” suction group application that has existed since the first version of E2 firmware. The Suction Group uses PID Control and with proper optimization it can achieve very tight suction pressure or temperature control, but compressor cycling is not based on load analysis and can be inefficient, especially in larger racks. All versions of E2 support the standard Suction Group application.
- *Enhanced Suction Group* - Introduced in E2 version 2.30F01, the Enhanced Suction Group has all of the important features of the older Suction Group application, but instead of employing user-configured PID constants to optimize operation, the Enhanced Suction Group determines optimum control by “learning” the effect each compressor and circuit load has on the suction input. The Enhanced Suction Group is easier to configure and more conservative with compressor cycling than the standard Suction Group. In addition, the Enhanced Suction Group also supports use of the Copeland Digital Scroll and Copeland Digital Discus compressors.

11.1.2 The (Standard) Suction Group Application

11.1.2.1 Overview of PID Control Strategy

A Suction Group application looks at suction pressure or suction temperature to determine how many compressor stages should be ON or OFF. The application compares the suction pressure or temperature to its control setpoint using PID control. The result of this comparison is a percentage from 0% to 100% that corresponds to the total capacity of the compressor rack that should be active.

The Suction Group application then takes that percentage and determines what combination of compressors

should be switched ON or OFF to best fulfill the requirement. For example, if the application says that 60% of the total compressor rack’s power should be active, and the rack has compressors totaling 50 HP, then E2 will try to switch on compressors totaling 30 HP.

For more information on PID, see *Appendix D: PID Control*.

11.1.2.2 Variable-Speed Compressors

Suction Group applications are compatible with variable-speed compressors. VS compressors allow Suction Group applications to “fine-tune” the amount of total active rack horsepower to react to small changes in suction pressures or temperatures. As a result, the rack does a better job of controlling suction, requiring less compressor switches.

When a variable-speed compressor is present, it will generally be treated as the primary pressure controlling device, and any other standard compressors in the rack are secondary devices used only if the VS compressor is unable to fully handle the required horsepower. The variable-speed compressor will be the first compressor on and the last compressor off.

11.1.2.3 Floating Setpoint Control

The Floating Setpoint strategy within the E2 RX provides a method for varying the suction setpoint of the group based on the temperature within a circuit. When Floating Setpoint Control is enabled, the E2 RX monitors either a circuit temperature or a case temperature from a CC-100 and adjusts the suction setpoint if the temperature is too low or too high.

The user establishes a range outside of which the E2 RX is instructed to make a one PSI adjustment to the suction pressure setpoint to either reduce or increase the case temperature. If the temperature continues to remain outside of the range for a user-defined period of time, the E2 RX continues to make pressure setpoint adjustments until the temperature is within the established range.

By varying the suction pressure setpoint to match the temperature requirements of the circuit, the E2 RX is able to ensure product integrity while achieving maximum rack efficiency.

11.1.3 The Enhanced Suction Group Application

A Suction Group application looks at suction pressure or suction temperature and compares it to the suction setpoint to determine whether compressor stages should be

cycled ON or OFF. Unlike the Suction Group application, which uses a PID percentage to determine how many stages to turn ON or OFF, the Enhanced Suction Group keeps historical data of the effects each compressor stage has on the suction pressure or temperature, and analyzes that data to determine which stages to cycle.

The Enhanced Suction Group application is designed to balance tight control of suction pressure with economic management of compressor cycling to reduce power usage and compressor wear.

11.1.3.1 Learning Mode

When an Enhanced Suction Group application runs for the first time, it undergoes a “Learning Mode” period to collect data on the compressor stages. During Learning Mode, the Enhanced Suction Group will control suction pressure, but it will purposely cycle the compressor stages in different combinations to measure the effect they have on the suction input value.

The Learning Mode lasts for several minutes. After Learning Mode ends, the Enhanced Suction Group will require up to 24 hours of operation before compressor cycling is operating at maximum efficiency. If compressor cycling seems too frequent after 24 hours of operation, you may reduce compressor cycling by changing the Control/Cycles parameter (see **Section 11.1.3.3, *The Control/Cycles Parameter***).

11.1.3.2 Circuit Load Analysis

Unlike the standard Suction Group algorithm, the Enhanced Suction Group includes Circuit Setup where you associate all circuits connected to the suction group. Once the circuits are set up, the suction group will use the circuit states to help determine current loads on the suction group. For example, when one or more circuits go into defrost, the Enhanced Suction Group determines that there is less of a load on the suction group than if all circuits were in refrigeration. With the appropriate circuits associated, the Enhanced Suction Group tailors its capacity to meet the load. Over time, the Enhanced Suction Group will build and store a profile for all the different combinations of circuit states encountered in the algorithm.

11.1.3.3 The Control/Cycles Parameter

Unlike the standard Suction Group, which used PID constants as a means of optimizing suction control and had limited features for controlling compressor cycle counts, the Enhanced Suction Group has one parameter with five preset settings to allow users to alter suction control performance or compressor cycling frequency.

The default setting, “Moderate Control,” seeks to balance good suction pressure control with efficient cycling. If tighter control is needed, setting the field to “Tight Con-

trol” or “Tightest Control” will increase the application’s reaction to suction changes, resulting in tighter control (usually at the expense of more frequent cycling). If fewer compressor cycles are desired, setting the field to “Less Cycling” or “Least Cycling” will decrease the number of cycles but also increase the amount of fluctuation in the suction pressure.

11.1.3.4 Variable-Speed, Digital Scroll, and Digital Discus Compressor Support

The Enhanced Suction Group supports variable-speed compressors similar to the Suction Group application. When a variable-speed compressor is present, it is the first compressor stage ON and the last stage OFF, and its capacity is varied to attempt to correct small fluctuations in the suction pressure or temperature.

In addition, the Enhanced Suction Group application supports use of one or multiple Copeland Digital Scroll or Digital Discus compressors for use as a variable-capacity compressor. With several Digital Scroll or Digital Discus compressors, the Enhanced Suction Group will modulate one of those compressors at a time to control suction pressure. As compressor capacity is added or removed, the Enhanced Suction Group may modulate another Digital Scroll compressor to distribute compressor resources and solenoid wear.

The operating capacities of the Copeland Digital Scroll and Copeland Digital Discus compressors are determined in the same way as a variable-speed compressor, except the Copeland Digital Scroll and Copeland Digital Discus controlled by pulse-width modulation (PWM).

11.1.3.5 Floating Suction Control

Floating suction control in the Enhanced Suction Group behaves identically to the way it works in the Suction Group application. Refer to **Section 11.1.2.3, *Floating Setpoint Control***.

11.1.4 Hardware Overview

An overview of the input and output devices that make up a Suction Group is shown in **Figure 11-1**. These devices should be wired to input and output boards in the manner outlined in **Table 11-1** and **Table 11-2**.

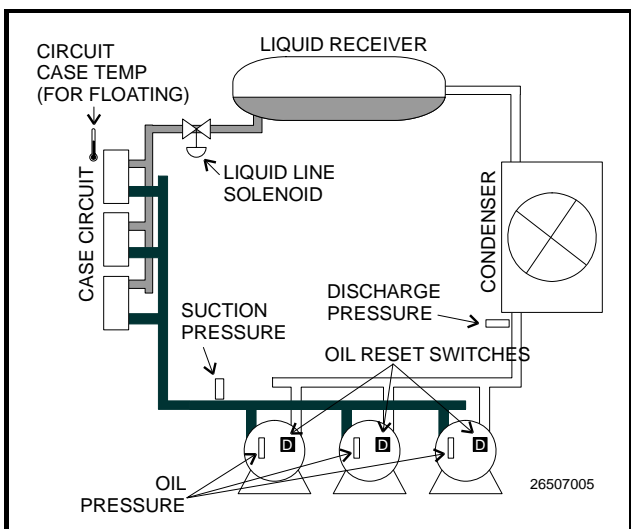

Figure 11-1 - Diagram of a Suction Group

Input	Sensor Type	Wiring Instructions
Suction Pressure	100 lb. Eclipse transducer	see Table 9-1 on page 9-3.
Discharge Pressure	500 lb. Eclipse transducer	see Table 9-1 on page 9-3
Oil Pressure	200 lb. Eclipse transducer	see Table 9-1 on page 9-3
Case Circuit Temperature	Temperature	see Table 9-1 on page 9-3
Oil Reset Switches	Digital	see Table 9-1 on page 9-3

Table 11-1 - Suction Group Inputs

Output Device	Wire Output Board Contacts to:	Set Failsafe Dip Switch to:	Notes
Compressor	N.C.	N.C. (up)	If you want a compressor to be OFF during network/power loss, use N.O. failsafes instead.
Unloader	N.C.	N.O. (down)	These fail-safe settings are specifically for unloaders.
Liquid Line Solenoid (LLS)	N.C.	N.C. (up)	Keeps solenoid energized during network/power loss.
Electric Defrost	N.O.	N.O. (down)	Keeps contacts de-energized during network/power loss.

Table 11-2 - Suction Group Outputs

11.2 Condenser Control

An E2 RX is capable of controlling air-cooled or evaporative condensers. The E2 RX-300 may control a single condenser, while the RX-400 may control up to two condensers.

11.2.1 Air Cooled Condensers

An air-cooled condenser consists of one or more fans that blow air across a manifold of tubing to cool heated refrigerant and condense it into a liquid. The E2 controls condensers by activating or deactivating fans in order to maintain discharge pressure or temperature at or below a chosen setpoint.

A Condenser Control application may use either of two strategies to operate air cooled condensers: an air-cooled strategy, or a temperature differential (T-D) strategy.

11.2.1.1 Air Cooled Strategy

The air cooled strategy uses a simple PID control loop

that compares a single Control In input to a PID setpoint. The resulting percentage is used to activate the condenser fan(s) necessary to bring the input value down below the setpoint.

Control inputs for air cooled strategies most commonly come from a pressure transducer mounted on either the discharge line, the condenser inlet, or the condenser outlet. However, temperature sensor values will also be accepted.

11.2.1.2 Temperature Differential Strategy

The temperature differential strategy attempts to keep a minimum amount of difference between the temperature of the refrigerant and the ambient outside temperature.

This strategy begins by determining the temperature of the refrigerant coming into the condenser. This can be supplied by either a temperature sensor or pressure transducer located near the condenser inlet; if it's a pressure transducer, its value will automatically be converted to a temperature value based upon the type of refrigerant.

The refrigerant temperature is subtracted from the value of an ambient air temperature sensor. The result is the **temperature differential**. It is this differential value that is compared to the PID setpoint for the purpose of determining the amount of total fan capacity to activate.

11.2.2 Evaporative Condensers

In an evaporative condenser, water is sprayed across a condenser coil, which cools the refrigerant as water is evaporated. Control of the evaporative condenser is similar in ways to the air cooled strategy in that the Condenser Control application uses PID control to activate or deactivate fans (thus increasing or decreasing the amount of evaporative cooling).

Like air-cooled condensers, evaporative condensers may be controlled by discharge pressure or temperature. They may also be controlled by water sump temperature. In addition, each evaporative condenser may have up to 16 “override” sensors (either temperature or pressure) that allow the condenser to be overridden to fast recovery mode (See **Section 11.2.5, Fast Recovery**).

11.2.3 Fan Control

Condenser Control applications can control three different kinds of fans: single-speed fans (up to 12 stages), two-speed fans, and variable-speed fans. All fan types are controlled by PID control; in other words, the Condenser Control application generates a percentage from 0% to 100% that corresponds to the amount of total fan power that should be active.

Single-speed fans translate the PID percentage into a percentage of total fan capacity. For example, if the PID percentage is 75%, then 75% of all condenser fan stages will be ON.

Two-speed fans use Cut In/Cut Out setpoints to translate the percentage into an OFF, LO, or HI fan state.

Variable-speed fans simply use the percentage to determine the fan speed. Thus, a 51% PID percentage will result in the fan running at 51% maximum speed.

VS-SS combined fan setup is for the combination of a variable-speed fan with single-speed fans. First, under PID control, the variable-speed (VS) fan turns on. Then as the PID percentage rises above VS fan’s maximum speed, the E2 switches on additional single-speed fan stages.

11.2.4 Condenser Split Mode

The E2 is capable of operating condensers in a special mode that reduces its condensing capacity. This special mode is called **split mode**.

Split mode is most often used in cold climates during periods of low outside air temperature. Split mode is also sometimes used when heated refrigerant from the refriger-

ation system is being used as reclaim heat by an HVAC unit.

The most common way E2 achieves split mode in an air-cooled condenser with single-speed fans is to lock OFF 50% of the total number of fans. You may choose to lock OFF all odd-numbered fans, even-numbered fans, the first half of all fans, or the last half of all fans.

Split mode can also be achieved by activating a valve that bypasses a portion of the tubing in the condenser manifold. The resulting decrease in surface area results in reduced cooling.

11.2.5 Fast Recovery

Under certain conditions the system pressure may increase too quickly above the condenser setpoint to be reduced effectively by normal condenser control. The E2 provides a user-definable fast recovery rate setpoint at which all the condenser fans are turned ON to reduce system pressure.

For air-cooled and temperature-differential condenser strategies, discharge pressure is always used as the control value that determines fast recovery. You may choose to enable or disable fast recovery, and also to include a delay when transitioning from one mode to the other.

For evaporative condensers, up to 16 “override” temperature sensors may be combined to yield a single override value that is used for fast recovery. Fast Recovery is always used in an evaporative condenser.

11.2.6 Hardware Overview

An overview of the input and output devices that make up a typical Condenser Control application is shown by **Figure 11-2** and **Figure 11-3**. **Figure 11-2** shows the typical layout of an air-cooled condenser. **Figure 11-3** shows the typical layout of an evaporative condenser.

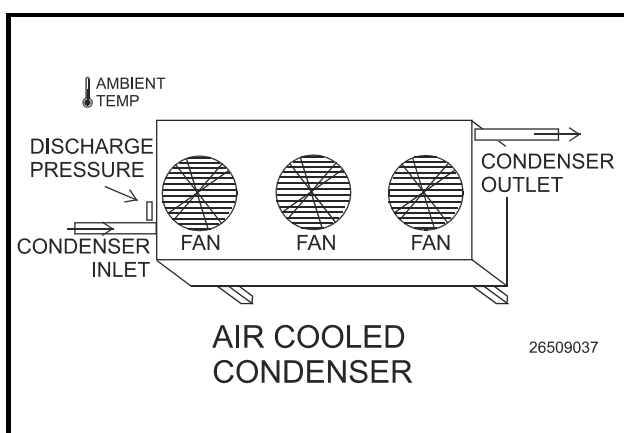

Figure 11-2 - Air Cooled Condenser Diagram

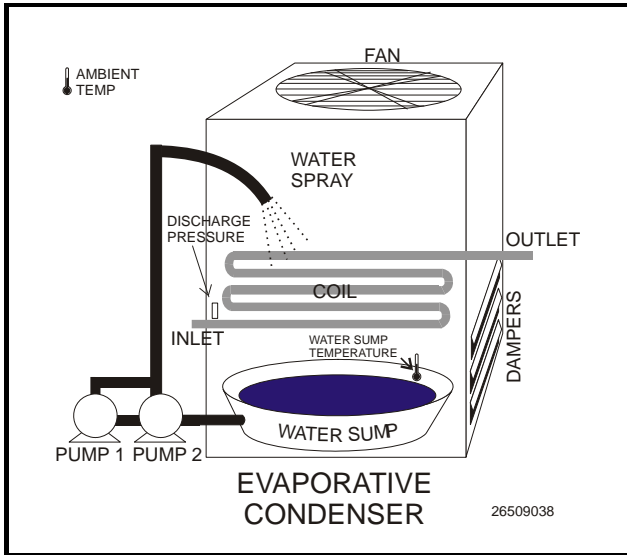

Figure 11-3 - Evaporative Condenser Diagram

Input	Sensor Type	Wiring Instructions
Discharge Pressure	500 lb. Eclipse transducer	see Table 9-1 on page 9-3
Ambient Temp	Temperature	see Table 9-1 on page 9-3
Water Sump Temp (Evap. only)	Temperature (Immersion)	see Table 9-1 on page 9-3
Override Temp Sensors (Evap. only)	Temperature (Pipe-Mount)	see Table 9-1 on page 9-3

Table 11-3 - Suction Group Inputs

Output Device	Wire Output Board Contacts to:	Set Fail-safe Dip Switch to:	Notes
Condenser Fan (Single-Speed)	N.C.	N.C. (up)	To ensure condensing during network and power failure, condenser fans should all be configured normally closed (N.C.)
Condenser Fan Relay (Variable-Speed)	N.C.	N.C. (up)	The fan should operate at 100% during loss of communication with E2.
Dampers (Evap. only)	N.C.	N.C. (up)	Dampers should be open during communication loss (N.C.).
Evaporator Pumps (Evap. only)	N.C. (see note)	N.C. (see note)	Some condensers have dual pumps that cycle at even intervals. One pump should be wired N.C. and the other N.O., so that only one pump runs during communication loss.
Variable-Speed Fan Output (to inverter)	None (analog point)	None (analog point)	This 4AO or 8IO analog point sends the 0-100% fan speed signal to the inverter.

Table 11-4 - Suction Group Outputs

11.3 Standard Circuits

Refrigerated cases that do not use case controllers are controlled by Standard Circuit applications. In a Standard Circuit application, the E2 is responsible for all case monitoring and control; it uses the RS485 I/O Network to both gather case temperature inputs and activate or deactivate the liquid line solenoids, defrost modes, and fans. Also, circuits that use ESR8s and MultiFlex ESRs are controlled using Standard Circuits.

NOTE: Do not set up a Standard Circuit application for a case that uses a CC-100 or CCB case controller. These cases must use Case Circuit Control applications (see Section 11.4, Case Control Circuits).

11.3.1 Refrigeration Control

A Standard Circuit application may apply one of four different control methods to a case circuit: the Temperature Monitor method, the Temperature Control method,

and the Line Up(ESR)/Defrost method, and the Lineup(MFESR)/Defrost method.

11.3.1.1 Temperature Monitor

The Temperature Monitor method does not control case temperature. The application will read and record case temperature inputs, but it will not make any attempt to control temperature. The application will still initiate and control defrost, cycle fans, and perform other necessary functions.

11.3.1.2 Temperature Control

A Standard Circuit application using the Temperature Control method will pulse the refrigeration liquid line solenoid OPEN and CLOSED so as to control the case temperature to the user-defined setpoint. The application monitors up to six different temperature sensors in the circuit and combines them into a single value that is compared to the setpoint.

11.3.1.3 Line Up(ESR)/Defrost

In Line Up ESR, circuit temperature is controlled by an electronic evaporator pressure regulator (EEPR). The EEPR is controlled by a PID algorithm that steps the valve open from 0% to 100% based on how far away the circuit temperature is from the setpoint.

This strategy requires the use of the Echelon-based ESR8 stepper regulator output board, which has been discontinued and replaced by the I/O Network-based MultiFlex ESR.

11.3.1.4 Line Up(MFESR)/Defrost

In Line Up MFESR, circuit temperature is controlled by an electronic evaporator pressure regulator (EEPR). The EEPR is controlled by a PID algorithm that steps the valve open from 0% to 100% based on how far away the circuit temperature is from the setpoint.

This new strategy requires the use of the I/O Network-based MultiFlex ESR and should not be used with the Echelon-based MultiFlex ESR.

11.3.2 Defrost Control

Defrost cycles in a Standard Circuit application may be initiated in either of three ways: by schedule (at specific times of the day, programmed by the user), by external trigger (a user-initiated signal such as a switch or button), or by manual command (initiated on the E2 front panel by the user).

11.3.2.1 Defrost States

The defrost cycle for a Standard Circuit application consists of three steps.

1. *Pump Down (Elec & Hot Gas only)* - The defrost cycle begins with this step immediately after the

refrigeration solenoid is turned OFF. During the Pump Down phase, the application waits for a user-specific amount of time to elapse before turning on the defrost heat. This allows refrigerant in the evaporator to be evacuated before defrost heat is activated. The compressor(s) remain ON during Pump Down.

2. *Defrost* - During the defrost phase, refrigeration is disabled. If using electric defrost heaters will be ON. If using hot gas, heated refrigerant will be pumped through the coil. This phase will continue until the defrost is terminated (see **Section 11.3.2.3** for information on how defrost is terminated).
3. *Run-Off (Elec & Hot Gas only)*- After defrost heat is deactivated, the application waits for the Run-Off time to pass before re-entering refrigeration mode. This allows melted frost on the evaporator to drain from the coil so that it will not re-freeze when refrigeration begins again. After the user-specified Run-Off time has passed, the defrost cycle has ended.

11.3.2.2 Defrost Types

There are many different ways used to defrost a refrigerated case. A Standard Circuit application is capable of employing five different strategies to accommodate five different types of defrost.

Timed and Reverse Air

Timed defrost and Reverse Air defrost are two different defrost strategies, but both are alike in the way they are controlled by a Standard Circuit application. In both defrost types, no heat is applied to the evaporator. The application simply turns the refrigeration solenoid OFF for the duration of the defrost cycle.

When these defrost types are used, Pump Down and Run-Off times are not necessary; therefore, they will not be part of the defrost cycle.

Hot Gas and Reversed Cycle Hot Gas

Hot Gas and Reversed Cycle Hot Gas require the use of hot gas from the refrigeration lines. During these types of defrost, the application will open the circuit's liquid line solenoid AND will send a command to the refrigeration rack to open the Master Liquid Line Solenoid. As a result, heated refrigerant will be pumped through the evaporator coil.

Any user-defined Pump Down and Run-Off times will be observed as normal.

Electric Defrost

Electric defrost uses electric heaters to defrost the evaporator coil. During electric defrost, the application

will turn the Defrost output ON to activate the heaters connected to the output.

Any user-defined Pump Down and Run-Off times will be observed as normal.

11.3.2.3 Defrost Termination

Both the start and the end times of a defrost cycle are determined by the user. The Pump Down, Defrost, and Run-Off stages all have fixed durations, and when the last stage of the cycle is complete, defrost is terminated.

However, a Standard Circuit application may be programmed to terminate the Defrost stage of the defrost cycle early if the temperature inside the case rises above a fail-safe temperature setpoint (called the termination setpoint). For certain defrost types, defrost heat may also be “pulsed” in order to keep the temperature below the setpoint without terminating defrost.

Pulsed Defrost

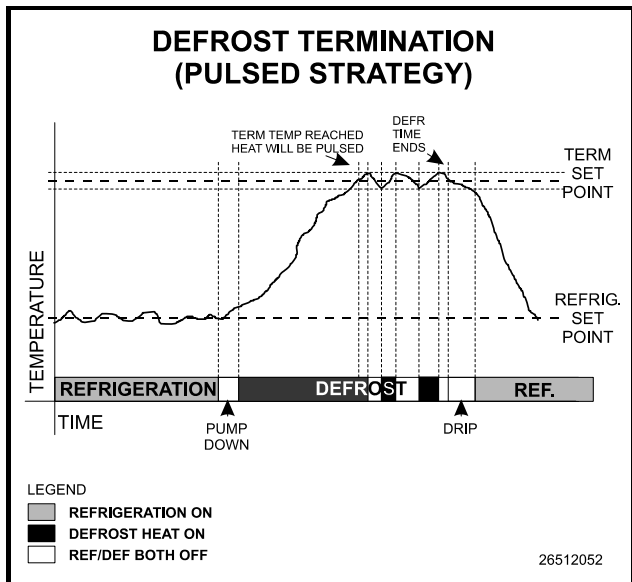

Figure 11-4 - Defrost Termination (Pulsed)

Pulsed Defrost is only available if the circuit is using heated defrost, such as Electric or Hot Gas defrost.

Pulsed Defrost is similar to the Temperature Termination strategy outlined in [Section 11.3.2.3](#), except a defrost cycle **always** continues for the full programmed duration.

When the termination temperature rises above the setpoint, defrost does not end. Instead, the defrost heat is turned OFF until the case temperature falls below the setpoint, at which time the output will come back ON to continue heating.

Figure 11-4 illustrates what happens in a pulsed defrost cycle. In this example, the case reaches its termination temperature approximately 2/3 of the way into its defrost cycle. Defrost continues, but defrost heat is turned

OFF until the temperature falls below the setpoint, at which point the heat is turned back ON.

Defrost heat will continue to be pulsed in this manner until the defrost time has passed. The defrost cycle will then begin the Run-Off period, and then restart refrigeration.

11.3.2.4 Emergency Defrost

When necessary, a user can initiate an emergency defrost cycle in a circuit. Emergency defrost cycles are similar to normal defrost cycles, except an emergency defrost cycle will ignore all calls for termination and remain in defrost for the entire programmed defrost time. For cases using a pulsed defrost strategy, this means the defrost heat will not be pulsed during emergency defrost.

Emergency defrosts are initiated by the user from the Standard Circuit Bypass screen (see [Section 12.6, Manual Defrost and Clean Mode](#)).

11.3.2.5 Hot Gas Defrost with ESR8 and MultiFlex ESR

If an ESR8 or MultiFlex ESR is used on a circuit that uses hot gas defrost, values for circuits in defrost are forced OPEN (100%) to allow hot gas to flow through the evaporators.

11.3.3 Clean and Door Switches

11.3.3.1 Clean Switches

A Standard Circuit application may be configured to entirely shut down a case circuit so that it may be cleaned or serviced. A case circuit enters clean mode when it receives a signal from an input called the clean switch.

Clean switches may be set up as either “Switched” or “Timed.” If a clean switch is configured as “switched,” the circuit enters clean mode when the switch is turned ON, and it remains in clean mode until the switch is turned OFF. If a clean switch is configured as “timed,” the circuit enters clean mode when the switch is turned ON, and it remains in clean mode for a fixed user-defined amount of time.

During clean mode, the Fan, Defrost, and Refrigeration Solenoid outputs are all turned OFF, and the liquid line solenoid is CLOSED.

If desired, a notice may be sent to the E2’s Alarm Log so that the E2 can keep track of clean modes and times.

11.3.3.2 Door Switches

Walk-In Box freezers are often equipped with door switches that disable the evaporators when the door is open. The E2 is capable of reading a digital door switch input and controlling the freezer appropriately.

When a door switch opens, the E2 will shut off the

refrigeration solenoid and the fans (if active) and turn the lights ON.

11.3.4 Fan Control

A circuit's circulation fan is always ON when the circuit is in refrigeration mode. Its state during defrost is determined entirely by how the application is programmed by the user. You may choose to set the fan either ON or OFF for each phase of a defrost cycle (Pump Down, Defrost, and Run Off). If you choose to keep fans off for the entire defrost cycle, you may also choose to program a delay that will keep the fan from activating for a fixed amount of time after the cycle ends.

Fans are locked OFF during clean mode.

11.3.5 The TD3 Temperature Display

The TD3 is a case display that is designed to monitor three types of temperature sensors. The compact unit is mounted on the face of a refrigeration case and displays, by default, the discharge air temperature. Pressing the function button repeatedly allows you to view the temperature of Retail Solutions' product probe, the defrost termination value, and then back to the discharge air temperature.

The TD3 has a status light that is controlled by the E2 controller. A green status light means that the status is okay while a red status light indicates alarm.

This case display can be configured to show either the discharge air temperature (default), the product probe temperature, or the defrost termination temperature.

The TD3 communicates with the E2 controller via the Echelon Network and in turn the E2 adjusts the circuit's temperature or defrost status.

11.3.6 The Control Link CD Case Display

The Control Link CD is mounted inside the refrigeration case and serves as a point to which the sensors are wired. A single RS485 communication cable links the case display back to the E2 controller. Additionally, an optional remote display can be added to the control module to provide a local indication of case temperature and operational mode that is remote from the control module.

11.3.7 Wiring

Wiring a case circuit so that it may be controlled by a Standard Circuit application primarily involves wiring all temperature sensors to 16AI Analog Input Boards and wiring the valves and other devices on the case to a relay output board such as an 8RO Relay Output Board.

Figure 11-5 shows a typical case in a circuit and the devices that must be wired for each. Follow the guidelines below to wire the circuit to the E2 I/O Network:

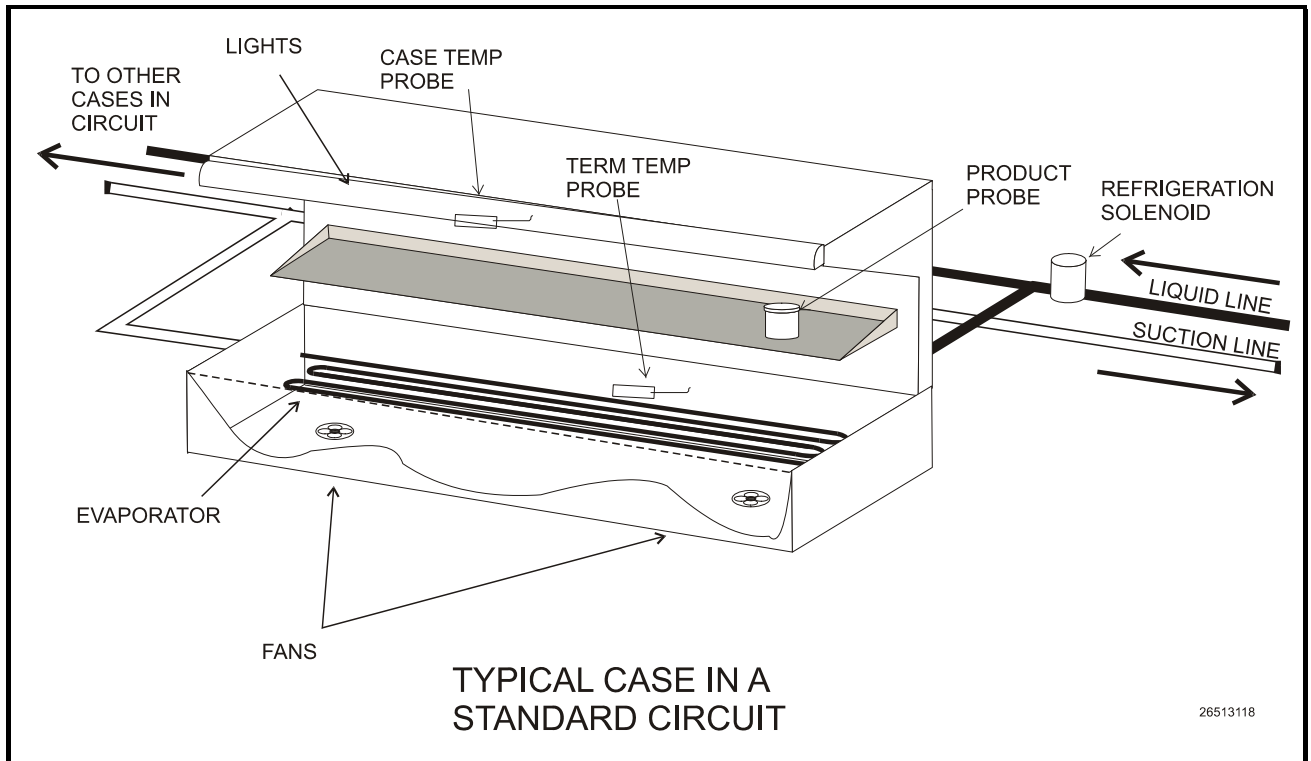

Figure 11-5 - Typical Case in a Standard Circuit

Input	Sensor Type	Wiring Instructions
Case Temp Probe (up to 6)	Temperature	see Table 9-1 on page 9-3
Defrost Termination Probes (up to 6)	May be digital (Klixon) or Temperature	see Table 9-1 on page 9-3
Product Probe (up to 6)	Temperature	see Table 9-1 on page 9-3
Clean Switch (not pictured)	Digital	see Table 9-1 on page 9-3
Door Switch (not pictured)	Digital	see Table 9-1 on page 9-3

Table 11-5 - Suction Group Inputs

Output Device	Wire Output Board contacts to:	Set Fail-safe Dip Switch to:	Notes
Case Fans	N.C.	N.C. (up)	Wire fans to remain ON during comm. loss
Refrigeration Solenoid	N.C.	N.C. (up)	Wire solenoid to remain energized (OPEN) during comm. loss
Defrost	N.O.	N.O. (down)	Defrost heaters (electric and hot gas) will remain de-energized (CLOSED) during comm. loss
Liquid Line Solenoid (Hot Gas defrosts only)	N.O.	N.O. (down)	The liquid line solenoid will remain de-energized (CLOSED) during comm. loss.
EEPR (ESR8 controlled circuits only)	None (ESR8 point)	None (ESR8 point)	The evaporator stepper regulator valve should be plugged in to a point on the ESR8 board.

Table 11-6 - Suction Group Outputs

11.4 Case Control Circuits

11.4.1 Overview

Case circuits that use CC-100s, CS-100s, EC-2s, or CCBs for case control rely on Case Circuit Control applications in the E2 to provide them the necessary setpoints, defrost scheduling, and other control parameters. Unlike Standard Circuit applications, Case Control Circuits do not directly control temperature in the case circuits; instead, the case controller controls temperature for each individual case based on the setpoint(s) supplied to them by their associated E2s.

Setup of a case-controlled refrigerated case system is a two-fold process:

1. For each case circuit in the refrigeration system, a separate Case Control Circuit application is created with its own set of control parameters.
2. Each CC-100, CS-100, EC-2, and CCB is **associated** with a Case Control Circuit application in the E2. Association creates a network link between the case controller and the application which supplies the information necessary to control temperature, defrost, lights, fans, and anti-sweat heaters.

This section of the manual covers both the programming of a Case Circuit Control application and the process of associating a CC-100, CS-100, EC-2, or CCB with a Case Circuit Control application.

11.4.2 Case Circuit Control Software Overview

There are six different versions of case control software in the Retail Solutions case control family:

- *CC-100P* - This version controls temperature in a case using a pulse modulated valve, which is pulsed ON for a percentage of a fixed amount of time to achieve the necessary refrigerant flow.
- *CC-100LS* - This version controls temperature in a case using a liquid-side stepper valve. This valve is capable of various positions in between 0% and 100%. As a result, the CC-100 is capable of supplying the exact refrigerant flow necessary to achieve the case setpoint.
- *CC-100H* - This version controls temperature in a case using a suction-side evaporator pressure regulator (EEPR). This valve is capable of various positions in between 0% and 100%. As a result, the CC-100 is capable of providing the exact suction pressure necessary to achieve the case setpoint.
- *CS-100* - This controller uses suction-side evaporator suction regulators (ESRs) to control suction pressure for an entire circuit. Unlike the CC-100, which controls only one case, the CS-100 controls all cases on an entire circuit.
- *EC-2s* - The EC-2 is a liquid-side pulse valve case controller that doubles as a case temperature and information display. Unlike the CC-100, it is designed to be mounted on the front of the case, and has a push-button front panel interface for program-

ming and viewing status. (The EC-2 29x version controls the refrigeration solenoid valve to allow the passage of refrigerant to the TXV valve, whereas the 39x version controls a pulse valve on the liquid side of the evaporator to regulate superheat.)

- *CCBs* - Version 2.3 and above of the E2 software is backward-compatible with the CCB, an I/O Network-based controller used primarily in old RMCC installations. Like the CC-100 family, the CCB was available in several different models that controlled liquid pulse, liquid stepper, suction stepper, and suction lineup.



NOTE: *There are several variations of the EC-2. Contact Retail Solutions at 1-800-829-2724 for more information.*

11.4.2.1 Valve Control

The CC-100 is capable of supporting two types of valves: pulse and stepper. The CC-100 uses PID control to vary the aperture rates of both valves between 0% and 100% as required by their temperature control algorithms (see **Section 11.4.3**, below).

Pulse Valves

A pulse valve is a device capable of being in only two states: fully open or fully closed. To achieve the necessary percentage of refrigerant flow, CC-100s repeatedly “pulse” these valves open for a percentage of an interval called the valve period (which defaults to six seconds).

For example, to achieve a 20% valve output in a CC-100 with a valve period of six seconds, a pulse valve would be opened for 20% of six seconds (or 1.2 seconds) and closed for the remaining 80% of the valve period (4.6 seconds). This same six-second sequence will repeat for as long as the CC-100 calls for a 20% valve output.

Stepper Valves

Stepper valves are devices that may be opened to many different positions between fully closed (0%) and fully open (100%). Stepper valves usually have hundreds or thousands of “steps” in between fully closed and fully open. To achieve the desired opening percentage, the CC-100 moves the valve the required number of steps.

To properly control a stepper valve, the CC-100 must know the operating characteristics of the valve, such as its maximum steps per second change rate, the total number of steps between 0% and 100%, and its hysteresis rate (the number of steps required for the valve to change direction).

11.4.3 Refrigeration Control

11.4.3.1 EEVs (Liquid Pulse and Liquid Stepper)

In CC-100P, CC-100LS, EC2, and CCB (liquid and pulse stepper) case controllers, there are two different control systems that work together to regulate refrigeration: temperature control and superheat control.

Temperature Control

Temperature Control measures the case temperature and turns refrigeration ON or OFF as required to keep the case within a certain proximity of the user-specified temperature setpoint.

The user supplies Temperature Control with the setpoint and a deadband, which is the range of case temperatures equally above and below the setpoint within which the case temperature will be considered acceptable. When the case temperature is above the setpoint plus one-half the deadband, refrigeration will be turned ON. It will remain ON until the temperature drops to below the temperature setpoint minus one-half the deadband, at which point refrigerant flow will be turned OFF.

Case temperature may be supplied to Temperature Control by a supply air sensor, a return air sensor, or a mixture of both the supply and return air sensor values.

Temperature Control itself does not vary the opening percentage of the pulse or stepper valve; it simply addresses the case’s need for refrigerant flow to maintain its setpoint. Once refrigeration is started, control of the valve is handled by Superheat Control.

Superheat Control

The difference between the temperature of the refrigerant going in to the evaporator inlet (the coil in temperature) and the refrigerant leaving the evaporator outlet (the coil out temperature) is called **Superheat**. When refrigerant is flowing through an evaporator, Superheat Control uses PID Control to keep the Superheat at a user-defined Superheat setpoint. Superheat Control positions the valve to increase or decrease refrigerant flow in an effort to keep the Superheat equal to a user-defined Superheat setpoint.

Recovery Mode

Recovery Mode is a special part of Superheat Control that occurs at the beginning of every refrigeration cycle. When refrigeration has been OFF and Temperature Control calls for refrigeration to be ON, a Recovery Mode begins, during which the valve is fixed to a user-defined percentage (usually 70%) for a fixed amount of time. This floods the previously empty evaporator with refrigerant and gradually establishes a differential between the coil in and coil out temperatures. When the Recovery Mode ends, the superheat will be relatively close to the setpoint; at this

time, Superheat Control will begin.

Recovery Mode always lasts for a specific number of seconds. The case controller determines the duration based on past performance of the evaporator during previous Recovery Modes.

Thermostatic Expansion Valves (TXVs)

As an alternative to regulating superheat using EEVs, case controllers also support cases that use mechanical thermostatic expansion valves (TXVs). When TXVs are being used, the case controllers use only Temperature Control to turn refrigeration ON and OFF. Superheat Control is disabled, since it is assumed the TXV is taking care of the superheat.

11.4.3.2 EEPs (Suction Stepper)

The CC-100H, CS-100, and CCB (suction stepper and lineup) control case temperature from the suction side of the evaporator by using an EEP to regulate suction pressure.

Suction-side control differs from liquid-side control in that Superheat Control is not used. In liquid-side control, the valve aperture is controlled in order to achieve a superheat setpoint. In suction-side control, the CC-100 changes the valve aperture to achieve the case temperature setpoint.

Case temperature may be supplied by a supply air sensor, return air sensor, or a mixture of the two values.

Temperature Control uses PID control to operate the valve and keep the case temperature input value equal to the case temperature setpoint.

Recovery Mode

Recovery Mode for suction-side case controllers is slightly different than Recovery Mode for liquid-side controllers. Suction-side case controllers enter Recovery Mode only after a defrost or cleaning cycle, and it does so in order to bring the case temperature down to a level that is controllable by Temperature Control.

During Recovery Mode, the valve is opened to a fixed percentage until the case temperature falls below the case setpoint. When this occurs, the case controller exits Recovery Mode and begins normal Temperature Control.

11.4.4 Defrost Control

The physical aspects of defrost control, such as shutting off valves and turning on defrost heat sources, is handled by the case controller. When operating on its own, a case controller initiates defrost cycles at programmed time intervals. When connected to a Case Circuit application, the case controllers' defrost times are coordinated and scheduled by the E2.

11.4.4.1 Defrost States

The defrost cycle for a Case Circuit application consists of three steps. Of these three, steps #1 and #3 apply only to cases with heated defrosts:

1. *Pump Down* - The defrost cycle begins with this step immediately after the refrigeration solenoid is turned OFF. During the Pump Down phase, the application waits for a user-specific amount of time to elapse before turning on the defrost heat. This allows refrigerant in the evaporator to be evacuated before defrost heat is activated. The compressor(s) remain ON during Pump Down. Pump Down times may only be used for hot gas and electric type defrosts.
2. *Defrost* - During the defrost phase, refrigeration is disabled. If using electric defrost heaters will be ON. If using hot gas, heated refrigerant will be pumped through the coil. This phase will continue until the defrost is terminated (see **Section 11.3.2.3** for information on how defrost is terminated).
3. *Run-Off* - After defrost heat is deactivated, the application waits for the Run-Off time to pass before re-entering refrigeration mode. This allows melted frost on the evaporator to drain from the coil so that it will not re-freeze when refrigeration begins again. After the user-specified Run-Off time has passed, the defrost cycle has ended.

Run-Off times may only be programmed for hot gas and electric type defrosts.

11.4.4.2 Defrost Types

There are many different ways used to defrost a refrigerated case. A case controller is capable of using three different types of defrost.

Off Cycle (Timed)

Off Cycle defrost (also known as Timed defrost) is simply a period of time during which refrigeration is suspended. No heat is applied to the evaporator. The application simply turns refrigerant flow OFF for the duration of the defrost cycle.

When these defrost types are used, Pump Down and Run-Off times are not necessary; therefore, they will not be part of the defrost cycle.

Hot Gas and Reversed Cycle Hot Gas

Hot Gas and Reversed Cycle Hot Gas require the use of hot gas from the refrigeration lines. During these types of defrost, the application will open the valve and pump heated refrigerant through the evaporator coil. Any user-

defined Pump Down and Run-Off times will be observed as normal.

Electric Defrost

Electric defrost uses electric heaters to defrost the evaporator coil. During electric defrost, the application will turn the Defrost output ON, which will likewise activate the heaters connected to the power module's defrost relay.

Any user-defined Pump Down and Run-Off times will be observed as normal.

11.4.4.3 Defrost Termination

Both the start time and the end time of a defrost cycle are determined by the user. The Pump Down, Defrost, and Run-Off stages all have fixed durations, and when the last stage of the cycle is complete, defrost is terminated.

However, a case controller may be programmed to terminate the Defrost stage of the defrost cycle early if the temperature inside the case rises above a fail-safe temperature setpoint. For certain defrost types, defrost heat may also be "pulsed" in order to keep the temperature below the setpoint without terminating defrost.

Temperature Termination

One or more temperature sensors in the case circuit may be designated as termination temperature sensors. The values of these sensors are combined into a single control value, and this value is compared to the setpoint. If the termination control value is greater than the user-defined setpoint, defrost will end, and the defrost cycle will begin the Run-Off period (if applicable).

Termination sensors may be either analog temperature sensors or digital closures (Klixons). Also, Case Circuit applications may use the value of the analog case temperature sensors for use in temperature termination.

Pulsed Defrost

Pulsed Defrost is only available if the circuit is using Electric or Hot Gas defrost.

Pulsed Defrost is similar to Temperature Termination, except when the termination temperature rises above the setpoint, defrost does not terminate. Instead, the output that applies defrost heat is turned OFF. The output will remain OFF until the temperature falls below the setpoint, at which time the output will come back ON.

The Case Circuit application will continue to pulse defrost in this manner until the defrost time has passed. The defrost cycle will then begin the Run-Off period.

11.4.4.4 Demand Defrost

If a case is configured with a demand defrost sensor, a case controller may use their inputs as a means of keeping scheduled defrost cycles from occurring when frost levels

are not high enough to require a defrost.

The optical demand defrost sensor may be either an analog or digital type sensor. When this sensor detects no major build-up of frost, the Case Circuit application ignores all scheduled calls for defrost and continues in refrigeration mode. When the sensor detects frost, the defrost inhibit is cancelled, and the case circuit will enter defrost at the next scheduled time.

A demand defrost inhibit only keeps scheduled defrosts from occurring. Any manual calls for a defrost cycle will occur as normal. CCB demand defrost is currently not supported in E2. Demand sensors, if present on the circuit, will be ignored.

Demand Fail-Safe Time

To protect against demand defrost sensors that may not be working properly, a demand fail-safe time may be set up. Demand fail-safe times limit the amount of time a defrost inhibit may last. If a demand defrost sensor does not detect frost for an amount of time equal to the Demand Fail-Safe Time, the defrost inhibit is lifted and the circuit will enter defrost at the next scheduled time.

11.4.4.5 Emergency Defrost

When necessary, a user can initiate an emergency defrost cycle from a circuit. Emergency defrost cycles are similar to normal defrost cycles, except an emergency defrost cycle will ignore all calls for termination and remain in defrost for the entire programmed defrost time.

Emergency defrosts are initiated by the user from the Case Control Circuit Bypass screen (see **Section 12.6, Manual Defrost and Clean Mode**).

11.4.4.6 The WAIT State

When a Case Control Circuit application enters defrost mode, it sends a message out to all case controllers in the circuit to begin defrost at the same time. However, since each case in a circuit will have its own termination sensors, it is possible for some cases to terminate defrost while defrosts in other cases continue.

When a case controller terminates defrost, it enters a state of operation called "the WAIT state." While in the WAIT state, all refrigeration and defrost heat will remain OFF. When the Case Control Circuit application detects that all case controllers have entered the WAIT state, the application will consider the defrost cycle completed, and refrigeration will restart.

11.4.5 Anti-Sweat Control

A case controller manages its anti-sweat heaters by monitoring the dewpoint in and around the case area. The dewpoint input value is compared to the anti-sweat application's control setpoints (the Full ON setpoint and the

Full OFF setpoint). Based on this comparison, the anti-sweat heaters will do one of three things:

- If the input is equal to or above the Full ON setpoint, the heaters remain ON 100% of the time.
- If the input value is equal to or below the Full OFF setpoint, the heaters will be ON 0% of the time (fully OFF).
- If the input value is between the Full ON and Full OFF setpoint, the heaters will be pulsed ON for a percentage of the specified time interval. The percentage is determined by proportionately measuring where the dewpoint falls between the range of values formed by the two setpoints.

Figure 11-6 shows an example of how anti-sweat control works. The setpoints (Full ON dewpoint= 80°F, Full OFF dewpoint = 20°F) form the range of dewpoints across which the heaters will be pulsed. When the measured dewpoint is 45°F (directly in between both setpoints), the percentage will be 50%, and the heaters will be pulsed ON for 5 seconds of the defined 10-second interval. If the dewpoint drops to 30°F, the percentage will lower to 20%, and the heaters will be on only 2 seconds out of every 10.

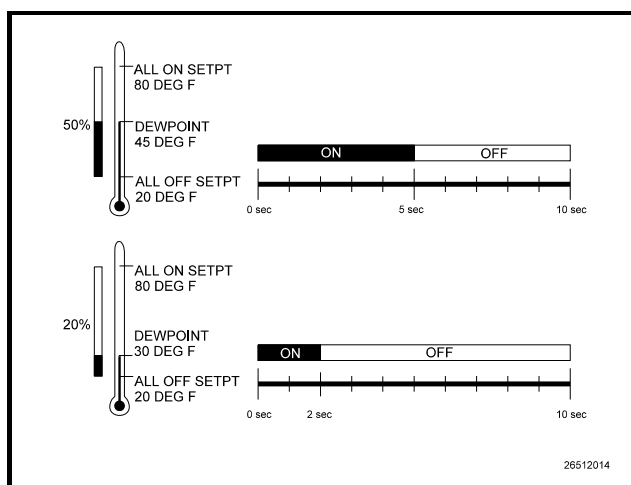

Figure 11-6 - Illustration of Anti-Sweat Control

11.4.5.1 Dewpoint Input Sources

Dewpoint control inputs for the case controller's Anti-Sweat algorithms must come from a dewpoint probe set up on the E2 I/O Network.

Note that when using a dewpoint probe on the E2 I/O Network, the case controller will rely on the E2 to provide the anti-sweat control value. If communications with the E2 are lost, the case controller will enter Fail-Safe Mode (see **Section 11.4.11**) and default to a fixed 50% output.

11.4.6 Dual Temp Control

A case controller can be configured to change its case temperature, alarm, and superheat setpoints when an external digital input is switched ON or OFF.

The user simply connects the digital switch to an input point on the RS485 I/O Network and configures the case controller to read that input as a dual temp switch. When the dual temp switch is ON, the case controller overrides its normal case temperature, alarm, and superheat setpoints with a set of user-specified alternate setpoints.

11.4.7 Fan Control

A relay on the power module activates the case fans. The fans will be ON while in refrigeration mode, and they may be programmed to be either ON or OFF when the temperature setpoint is satisfied and refrigerant is not flowing.

When in defrost mode, the fans default to OFF, but they may be programmed by the user to be either ON or OFF.

When a liquid-side CCB is in Recovery Mode (see **Recovery Mode**, page 9-10), Fan Control may be configured to delay the activation of fans for a user-specified amount of time. This delay helps keep the fans from splashing excess moisture that may still be on the coil.

11.4.8 Light Control

Lights are activated and deactivated by a relay on the power module.

The case controller itself does not have any special control algorithm for the case lights other than to leave the lights ON during normal operation. There are only two cases where the lights are not always ON:

1. An override from an E2 takes over control of the case lights. This override may take the form of a manual switch or a schedule output.
2. If the case controller is set up to use Walk-In Box Control, the case lights default to OFF and only come ON when the door switch is tripped. See **Section 11.4.10, Walk-In Freezer Control**.

11.4.9 Clean/Wash Mode

Clean Mode is a special kind of case deactivation designed specifically for washing or performing maintenance on the case.

Clean Mode is initiated by activation of a cleaning switch input or by a command sent from a Hand-held Terminal or an E2. During Clean Mode, refrigerant flow is turned OFF, all fans and anti-sweat heaters are deactivated, and the lights are turned either ON or OFF as programmed by the user.

Clean Modes may be either fixed or timed. Fixed Clean Modes begin when the clean switch is turned ON and end when the clean switch is turned OFF. Timed Clean Modes begin when the clean switch is turned ON and ends a specific time afterwards. The user specifies how long the wash mode will last.

End of Mode Warning

To warn service personnel that wash mode is about to end, the case controller will blink the case lights for five seconds. After five seconds of blinking, the case fan will activate and refrigeration will restart.

11.4.10 Walk-In Freezer Control

The CC-100P and CCB (dual-pulse valve model) case controller is used to control walk-in boxes, since it is the only model capable of controlling two valves.

Walk-in boxes are controlled the same way as for other cases. The primary difference between walk-in boxes and other cases is the use of the door switch.

When the case controller's door switch input is turned ON, refrigeration is suspended (all pulse valves go to 0%), the fans turn OFF, and the lights turn ON. The walk-in box remains in this state until the door switch turns OFF again.

Alarm times can be assigned to the door switch input so that an alarm can be generated when the door is left open for too long.

Also, when temperature alarm setpoints are configured for the case, the case controller will begin refrigeration if a temperature alarm trips with the door open.

11.4.11 Fail-Safe Mode

When major system malfunctions occur, the case controller enters a Fail-Safe Mode. The Fail-Safe Mode is designed to keep the case functioning as normally as possible under system conditions that would otherwise make case control impossible.

A case controller will enter Fail-Safe Mode whenever one of three conditions occur:

1. The superheat and/or temperature control setpoint(s) are corrupted (i.e., outside of its programmed minimum/maximum range).
2. The software is corrupted.
3. An unrecoverable sensor failure has occurred (see Operation with Failed Sensors, below).

Actions Taken During Fail-Safe Mode

When a case controller enters Fail-Safe Mode, each output will be set to the fail-safe state described in *Table 11-7*.

Output	Fail-Safe State
Pulse Valve, Stepper Valve	Controller will fix the position to the last known good output percentage
Fans	ON
Lights	ON
Defrost	OFF
Anti-Sweat	Pulse at 50%
CC-100 and CS-100 Alarm LEDs (red)	Flashes at a rate of 2 per second
Dual Temp Output	Off
Suction Solenoid Valve	Open
Liquid Solenoid Valve	Open
Satellite Output(s)	OFF

Table 11-7 - Fail-Safe States

11.4.11.1 Recoverable Sensor Failures

The CC-100 and CS-100 will be able to cope with some sensor failures without having to enter Fail-Safe Mode.

Coil In or Coil Out Failure

A coil inlet temperature or coil outlet temperature sensor will be considered failed if one of two conditions occur:

1. The sensor gives a value outside of its minimum and maximum temperature range (that is, below -50°F or above 120°F) for two consecutive readings, or
2. The sensor value is 20°F above the control setpoint for longer than ten minutes.

If the coil inlet or coil outlet temperature sensor has failed, the case controller will compensate by "guessing" the inlet or outlet temperature based on the values of the remaining functional coil sensor and the case temperature sensor(s). The case controller will continue to guess the value until the coil inlet or outlet sensor can be fixed.

If both the coil inlet and coil outlet sensors have failed, or if one coil sensor and the case temperature sensor(s) have failed, the case controller will not be able to make the required calculations, and they will go into Fail-Safe Mode.

Discharge/Return Air

If the sensor or combination of sensors supplying the case temperature to the case controller have failed (i.e., the

case controller has no usable case temperature input value), the case controller will keep the valve percentage at its last known good value and continue operation as normal. For instance, if the valve was at 75% when the case temp sensor(s) failed, the valve will remain at 75% until it the failure is corrected. All other case control functions will continue functioning as normal.

11.4.12 Wiring

Input and output wiring for a case controller is discussed in detail in **Section 4, E2 Hardware Setup**. Before a Case Control Circuit application may begin functioning, all case controllers must be properly connected to its case inputs and outputs, and each case controller must be commissioned and properly communication on the Echelon Network (see **Section 4, E2 Hardware Setup** for instructions on how to do this).

11.4.13 Setting Up An Individual Case Controller

Most of the data required for a case controller to begin operation are supplied to it by associating the controller with an E2. However, in some cases, it will be necessary to change some of the parameters in an individual case controller. Some instances where it will be necessary are:

- When the configuration for the inputs needs to be changed (i.e., when the case has a sensor or switch configuration that cannot be satisfied by the default configuration).
- When a valve other than an Emerson Flow Controls ESR-12, ESR-20, or ESV is being used. Each case controller is programmed by default to operate Emerson Flow Controls brand valves. If the valve type is different, the valve control parameters must be changed in the case controller software.
- When the PID settings that determine the valve aperture or closure require alteration.

When necessary, the case controller can be altered in either of two ways. You can change settings in a case controller application in E2 via the front screen. Or, you can use a Hand-held Terminal to log in to the CC-100 or CS-100 directly, and make temporary changes that will not be saved.

11.4.14 Associating Case Controllers with Case Circuit Control Applications

Before you can program a Case Control Circuit with the necessary parameters, you must associate the appropriate CC-100s, CS-100s, EC-2s, and CCBs with the Case

Control Circuit application you will be programming.

To access the CC/CS-100 Case Control Association Screen:

1. Press **Menu** for the Main Menu.
2. Press **& 7** for System Configuration.
3. Press **& 7** for the Network Setup menu.
4. Press **\$ 4** for Case Control Associations. The Case Control Association screen should look like **Figure 11-7**:

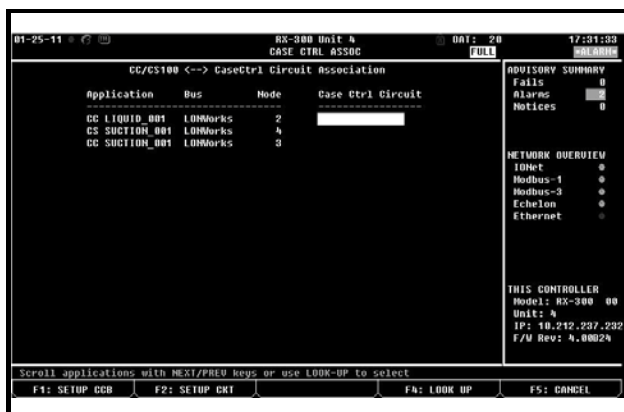

Figure 11-7 - CC/CS100 Circuit Association Screen (RX-400)

This screen lists all of the CC-100s, CS-100s, EC-2s, and CCBs defined in this E2. Each one is listed with its name, its node number, the application name of the case controller's application, and the associated circuit name.

To associate a case controller with its circuit, move the cursor into the Circuit field of the controller you wish to associate, and press the **F4** key. The Application Selection menu will list all of the Case Control Circuit applications in the E2. Choose the desired circuit and press **F1** or **F2** to select. Repeat this process until all case controllers are associated with Case Control Circuit applications.

11.5 Logging Groups

A logging group is a set of application property inputs and outputs whose values are recorded (logged) with the same parameters. Parameters include the interval, how often the property values are logged (for example, every 30 seconds, every 5 minutes, etc.), the duration of the log (for example, 2 days, 30 days, 100 days, etc.), and the resolution (how precisely the analog values are recorded).

11.5.1 Possible Data Errors

For point log groups, regardless of the resolution, the following applies when errors occur in log data:

Displayed Value	Logged Value	Description
NO DATA	(LOG_DATA_NONE)	Actual data value of the output is NO_VALUE but output status is not CELL_OUT_FAIL or CELL_OUT_INACT
PT FAIL	(LOG_PT_FAIL)	Data is NO_VALUE and status of output is CELL_OUT_FAIL -- could occur when point cell has passed one minute update
PT INACT	(LOG_PT_DISABLED)	Status of output is CELL_OUT_INACT and this appears regardless of the value of the data – this may occur at startup
ERROR		Indicates log error type could not be determined but the LOG_ERROR_FLAG was set in the data (this is display only and might indicate corrupted data)

Table 11-8 - Data Errors

A displayed value of DATA N/A (LOG_DATA_NA) is used in medium and low resolution logs when that particular type of data cannot be logged in that resolution. Pulse, one shot, and system list types cannot be logged in medium and low resolution log groups.

11.5.2 Data Compression

Because the user may need to log more data than the default logging of the E2 can hold in memory, the user can set the resolution type in the log manager to determine how the desired points will be logged. E2 converts these analog sample values to this lower resolution (Low or Medium) by:

- Adding/subtracting an offset
- Multiplying by a scaling factor
- Rounding to the nearest integer value of the size appropriate for the desired resolution

11.5.2.1 Clipping

Clipping occurs whenever the conversion process results in a sample value that falls outside the range of the selected log resolution. For example, converting a value of 750 PSI to low resolution would result in a compressed sample value of 609 PSI (refer to *Appendix E: Com-*

pressed Point Log Sample Limits and Precision Tab).

Low resolution only allows values up to 609 PSI; therefore, the sample is said to be “clipped.” If the value that will be logged is anticipated to exceed the high or low range for a particular log resolution, a higher resolution should be chosen.

High Clipping occurs when a compressed sample value is *above* the range allowed by the set resolution. In this case the sample value is considered “high-clipped” and the data recorded will be the high-clipped value and logged at the highest possible valid value.

Low Clipping occurs when a compressed sample value is *below* the range allowed by the set resolution. In this case the sample value is considered “low-clipped” and the data recorded will be the low-clipped value and logged at the lowest possible valid value.

11.5.2.2 Incompressible Data Types

Points of certain data types cannot be compressed due to the nature of their data values. These points are called Incompressible Points. Refer to the following table for the data types that are considered to be incompressible at certain resolutions:

Data Type	Incompressible at Resolution
PULSE_TYPE	Low and Medium
ONE_SHOT_TYPE	Low and Medium
SYS_LIST_TYPE	Low and Medium

Table 11-1 - Incompressible Data Types and Their Resolutions

11.5.3 Base Log Group

The Base Log group is a permanent logging group and cannot be deleted. When a new application is added to the system, the inputs and outputs that are logged by default are associated with the Base Log group.

Points are pre-configured to be logged for newly added applications. Many of the most important inputs and outputs within an application are already pre-configured to be logged, and all of these inputs belong to the Base Log Group. Simply define the inputs and outputs to enable logging; no special set up is required. Logging is done automatically.

When you first create an application in the E2, you can tell which inputs and outputs belong to the Base Log Group: an “L” will be displayed at the right-hand side of their definitions. The “L” is a marker that signifies that the input or output is currently part of a logging group (either the Base Log Group or another group as assigned by the user). If there is no “L” beside the definition, the value is

not part of a logging group and therefore will not be logged.

11.5.4 Setting Up Logging

To begin logging setup, go to the Logging Setup menu:

1. Press **Menu** for the Main Menu.
2. Press **8/7** System Configuration.
3. Press **A/6** Logging Setup.

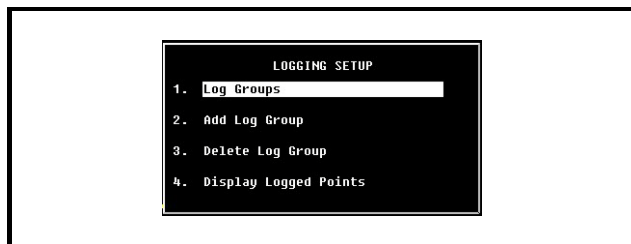

Figure 11-8 - Logging Setup Menu

From this menu, you can control different logging aspects:

- Access Log Group summary screen (or Base Log if no additional log groups exist) to set logging parameters
- Add a new log group and automatically enter edit mode
- Delete a log group
- Displays a report of all logged points for the entire system

For Base Log setup, select **1. Log Groups** from this menu:

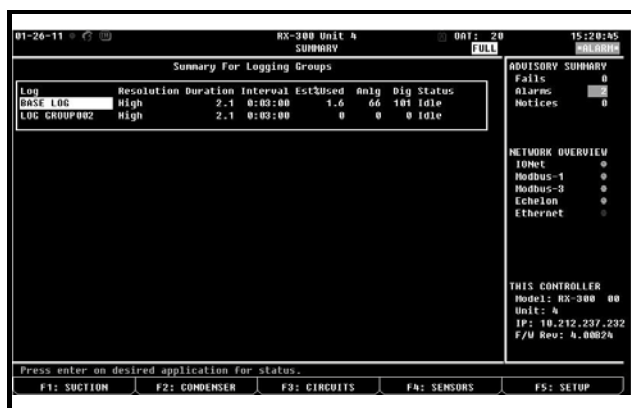

Figure 11-9 - Summary Screen for Logging Groups

The summary screen for Logging Groups will open where a variety of log parameters can be viewed. Log

group name, configured resolution setting, number of days to keep logs, the amount of available logging resources, number of analog and digital points associated with this logging group, status, and more can all be seen from this summary screen.

Highlight the desired logging group and press **F5** to open the setup screen for that log group:

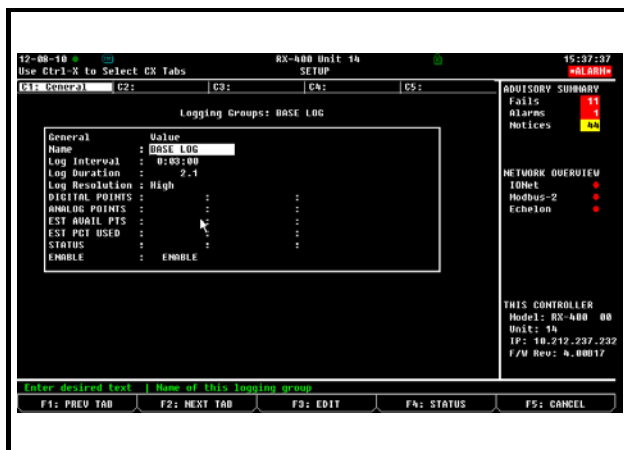

Figure 11-10 - Logging Setup

From this screen, logging group configuration can be specified. Group name, interval between log records, mode, start date and time, duration of logs, log resolution, points, percentage used, status, and enable/disable logging can be configured. (See the online help for each property for more information on what individual parameters do.)

11.5.5 Logging Group Status Screen

From the Logging Group Summary screen, you can also access the Status screen for any logging group in the list by highlighting the desired group and pressing Enter:



Figure 11-11 - Status Screen for Logging Groups

From the Status screen you can:

- View configuration and usage information for the selected logging group.
- Display the Logging Group Report (press **Enter, 8, 1**).
- Display the Application Log Report (press **Enter, 8, 2**).
- Turn off logging for all points associated with that logging group (press **Enter, 9, 1**).
- Go back to the Setup screen (press **F5**).

11.5.6 Log Reports

A selection of log reports are available that indicate system resource usage (how much disk space logging configurations use), resolution settings, the duration logs are stored, number of analog and digital points, and all the types of logged points that belong to groups, specific applications, or the entire system.

11.5.6.1 Logging Group Report

The Logging Group Report provides a summary of the logging group configuration and a complete list of all points associated with that group. To display the Logging Group report:

1. From the Status screen of the desired Logging Group application, press the Enter key to bring up the Actions menu.
2. Press **8. Application Logs/Graphs** to bring up the APPLICATION SPECIFIC LOGS AND GRAPHS menu.
3. Press **1. Logging Group Report**.

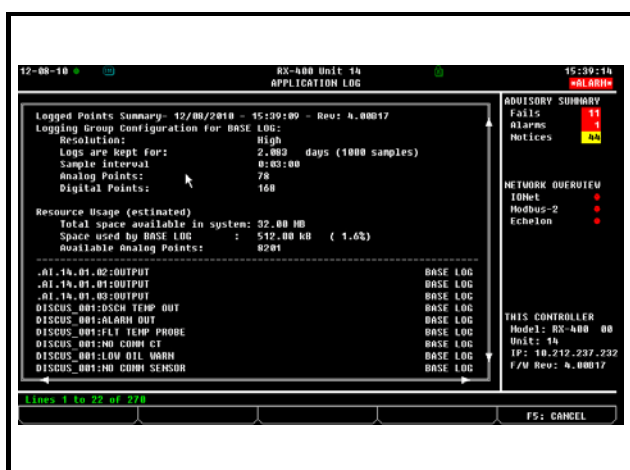

Figure 11-12 - Logging Group Report Example

11.5.6.2 Application Log Report

The Application Log report provides a summary of all logged points for the current application and a complete list of all the logged points that belong to that current application. To display the Application Log report:

1. Press the Enter key to bring up the Actions menu from the desired application Status screen.
2. Press **8. Application Logs/Graphs** to bring up the APPLICATION SPECIFIC LOGS AND GRAPHS menu.
3. Choose **Application Log Report**.

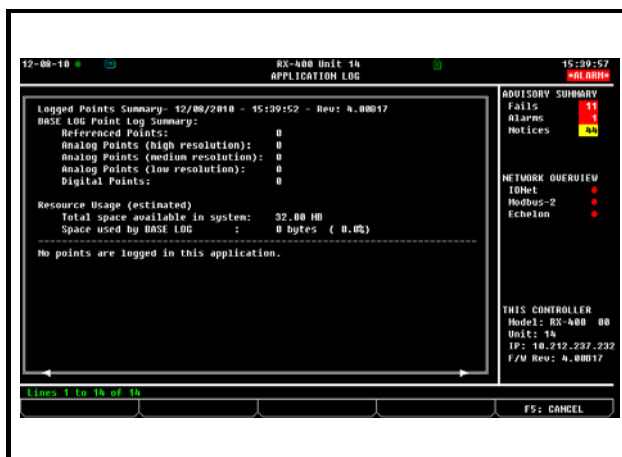

Figure 11-13 - Application Log Report Example

11.5.6.3 System Log Report

The System Log report provides a summary of all logged points for all applications in the system and a complete list of logged points for all applications in the system. Note that depending on the size of the configuration and the number of points logged, this may take a few seconds.

To display the System Log Report:

1. Press **Menu** for the Main Menu.
2. Press **8 & 7** for System Configuration.
3. Press **A 6** Logging Setup.
4. Press **S 4** Display Logged Points.



NOTE: Depending on the number of points logged and the resolution setting, a limited amount of memory space is available for one-year logging.

```

12-08-10 08:00:00 BX-AB0 Unit 14 15:01:00
RX DEU SUMMARY
Logged Points Summary- 12/08/2010 - 15:00:00 - Rev: 9.00017
-----
Log Group Resolution Days Interval Est Used Analog Digital
-----
BASE LOG High 2.000 0:00:00 1.6 70 160

Point Logging Summary
Referenced Points: 11
Analog Points (high resolution): 70
Analog Points (medium resolution): 0
Analog Points (low resolution): 0
Digital Points: 160

Total Resource Usage (estimated)
Space available for log files: 32.00 MB
Space used by log files: 512.00 KB ( 1.6%)

-----
.01.14.01.02:OUTPUT BASE LOG
.01.14.01.03:OUTPUT BASE LOG
.01.14.01.03:OUTPUT BASE LOG
.00.14.01.02:INPUT -> DIG SENSOR001:COMMAND OUT BASE LOG
.00.14.01.07:INPUT -> CONDENSER001:FAN OUT1 BASE LOG
DISCUS_001:DSCH TEMP OUT BASE LOG
-----
Use arrow or page up/down keys to scroll the screen
F5: CANCEL

```

Figure 11-14 - System Log Report Example

11.6 Air Handling Units (AHU)

11.6.1 Overview

The E2 BX supports the simultaneous control of up to six air handling units (AHU). AHU Control applications govern all aspects of an AHU's operations, including heating and cooling, dehumidification, fans, and economizer control.

Unlike rooftop control units (RTUs), AHUs are controlled directly by the E2 itself and not by a separate unit control board.

An AHU Control application actually consists of three separate control algorithms. The main control algorithm monitors the indoor temperature and activates heating and cooling stages when necessary to maintain the user-defined temperature setpoint. Another algorithm monitors the indoor humidity and uses a desiccant wheel or additional AHU cool stages to reduce the humidity level. The third loop controls either a two-position (digital) or variable-position (analog) economizer damper based on the outside air conditions.

11.6.2 Temperature Control

In its most basic form, Temperature Control simply reads a control input value, compares it to the active temperature setpoint, and activates or deactivates heating or cooling stages in an effort to satisfy the setpoint. The majority of user setup that must be done in Temperature Control involves specifying which input is to be used as the control source, defining different setpoints for use in occupied, unoccupied, summer, and winter modes, and setting up the operating characteristics of the heating and

cooling stages.

11.6.3 Alternate Setpoints

For both the heating and cooling setpoints, you may choose to use different setpoints during occupied or unoccupied building times, and different setpoints for summer and winter seasons. In other words, AHU Control may have four different pairs of heating and cooling setpoints, as shown in *Table 11-9*.

Cooling	Heating
SUMMER COOL OCC	SUMMER HEAT OCC
SUMMER COOL UOC	SUMMER HEAT UOC
WINTER COOL OCC	WINTER HEAT OCC
WINTER COOL UOC	WINTER HEAT UOC

Table 11-9 - Possible Heating/Cooling Setpoints

AHU Control looks at the E2's Global Data parameters to determine whether it should run in summer or winter mode. Refer to *Section 10.17, Set Up Global Data*, for information on how to set up summer/winter control parameters.

The AHU chooses occupied or unoccupied mode by reading an occupied state input, which is most commonly tied to the output of a Time Schedule application.

11.6.4 Fan Control

The E2 BX can control three different types of AHU fans. However, only one fan can be controlled per AHU. The fan types include: single-speed, two-speed, and variable-speed. Controls for all fans are similar in that they operate in either of three modes:

- **Continuous** - The fan is always on, even when the AHU is not in heating, cooling, or dehumidification mode.
- **Auto** - The fan is only on when the AHU is in heating, cooling, or dehumidification mode.
- **Summer ON, Winter Auto** - This mode allows the AHU fan to operate in Continuous mode during the summer months and in Auto mode during the winter months.

The operation of the fans during Continuous and Auto modes is largely dependent on the fan type.

11.6.4.1 Single-Speed Fans

Single-speed fans require no advanced control parameters. Whether in Continuous or Auto mode, the fan will be ON when Fan Control calls for it to be ON, and OFF when it calls for it to be OFF.

11.6.4.2 Two-Speed Fans

Two-speed fans have a LOW and a HIGH speed setting. You must specify the number of the stage that, when activated, will switch the fan from LOW to HIGH.

For example, if there are four cooling stages and you wish to have the fan switch from LOW to HIGH when stage 3 becomes active, enter a “3” as the switch-over setpoint. This will cause the fan to switch to HIGH speed when stage 3 is activated. Likewise, when stage 3 is deactivated, the fan speed will switch from HIGH to LOW.

You may choose a different switch-over setpoint for occupied heating, occupied cooling, unoccupied heating, and unoccupied cooling modes.

When the AHU is in dehumidification mode, the AHU Control application will ignore the fan speed settings of the active stages and switch to a user-specified dehumidification speed (usually LOW).

Continuous Two-Speed Fan Operation When All Stages Are OFF

When the fan is operating in Continuous mode and all heating and cooling stages are OFF, the fan speed will default to a user-specified speed. You may choose a different default speed for both occupied and unoccupied operation.

11.6.4.3 Variable-Speed Fans

Variable-speed fans may operate at any percentage of its maximum speed. The method AHU Control uses to determine the speed percentage is dependent on whether the heat and cool outputs are staged or modulating.

Variable-Speed Fan Operation

For staged AHU outputs, each stage must be programmed with its own speed percentage setpoint. The AHU Control application looks at all of the active stages, takes the highest speed percentage setpoint, and operates the fan at this speed.

For example, if cool stage 1 is active with a 30% speed percentage setpoint, the fan will likewise operate at 30% speed. If a second stage with a setpoint of 50% were to become active, the fan speed would increase to 50%.

For each heating and cooling stage, you may specify both occupied and unoccupied speed percentage setpoints.

Dehumidification with VS Fans

When in dehumidification mode, a user-defined slow-down percentage is subtracted from the variable-speed fan percentage. This percentage will continue to be subtracted until the AHU exits dehumidification mode.

11.6.5 Economizer Control

Economizer dampers on AHUs are used to bring out-

side air into the building for use in cooling. When temperature and humidity conditions are favorable, the economization dampers are opened, and outside air is allowed to flow into the AHU. Economization is generally used by the AHU just as a cool stage would be in Temperature Control; if cooling is needed, and conditions are favorable for economization, the dampers will open and economization will begin. If more cooling is needed, the cooling stages would then cycle on as normal.

The E2 supports control of both two-position (digital) and variable-position (analog) economizer dampers.

11.6.5.1 Economization Enable

Before the AHU Control application may open economization dampers, it must first determine if the outdoor air conditions are favorable for economization. There are six possible ways the AHU Control may do this:

1. **Enthalpy Switch** - An enthalpy switch is a digital device that is pre-set to detect when the temperature and humidity levels are favorable for economization. When the conditions are favorable, this switch sends an OK (ON) signal to the AHU Control application. Otherwise, the switch sends a NOT OK (OFF) signal, and economization is disabled.
2. **Dewpoint Setpoint** - A dewpoint probe measuring the dewpoint of the outside air is compared to a setpoint. If the outside air dewpoint is less than the setpoint, economization is enabled. If it is higher than the setpoint, economization is disabled.
3. **Calculated Enthalpy** - The AHU Control application calculates the outside air enthalpy by reading the value of a relative humidity sensor and an outdoor air temperature sensor. If the enthalpy is lower than the setpoint, economization is enabled. If the enthalpy is greater than the setpoint, economization is disabled.
4. **Dewpoint Fail-Safe** - This is similar to method #2, except an outdoor temperature sensor value is compared to the setpoint instead of a dewpoint probe's value. This comparison is a poor substitute for actual dewpoint readings and is recommended for use as a fail-safe only. When possible, use humidity or dewpoint sensors.
5. **Temperature Comparison** - The AHU Control application simply compares the temperature of the inside air with the temperature of the outside air. If the outside air is cooler than the inside air, economization is enabled.
6. **In vs. Out Enthalpy** - This strategy requires indoor and outdoor humidity sensors and also

indoor and outdoor temperature sensors. The enthalpy of the outdoor air is calculated and compared to the enthalpy of the indoor air. If the outdoor air enthalpy is less than the indoor air enthalpy, economization is enabled. Otherwise, economization is disabled.

You may choose a different economization checking method for use in summer and winter months.

11.6.5.2 Economization Lockout Features

In addition to the methods listed above, there are two economization lockout features that apply to all AHUs using economization.

Max Outside Air Humidity

The Max Outside Air Humidity is the highest allowable humidity level for the outside air. If the outside relative humidity is higher than this setpoint, economization will not be allowed to occur.

Minimum Supply Temp

The Minimum Supply Temp is a user-defined setpoint that locks out economization if the supply air temperature falls below a minimum supply temperature setpoint. This feature ensures that the air coming from outside is not too cold.

11.6.6 Digital Economizer Control

Control of digital or two-position economizers is relatively simple. When conditions are favorable for economization, the dampers will be opened when cooling is needed. If not favorable, the dampers will be closed.

11.6.7 Analog Economizer Control

For variable-position dampers, economization is generally used by the AHU just as a cool stage would be in Temperature Control. If cooling is needed, and conditions are favorable for economization, the dampers will open and economization will begin. If more cooling is needed, the cooling stages would then cycle on as normal.

The position of the analog economizer damper is important only for the purposes of keeping the mixed air temperature (a combination of the outdoor air coming through the dampers and the return air temperature) near the user-specified setpoint. The damper is controlled using PID control.

11.6.8 Dehumidification Control

Dehumidification control uses the AHU's existing cool stages (and a separate dehumidification device such as a desiccant wheel, if available) to remove moisture from the air.

The dehumidification setpoint is placed at the 0% end of the dehumidification PID throttling range. In other

words, the dehumidification output will start at 0% when the humidity is equal to the setpoint and increase to 100% when the humidity is equal to or above the setpoint plus the throttling range.

The dehumidification output percentage is used much like a heating or cooling output percentage is used in Temperature Control. The percentage represents the percentage of total dehumidification capacity available to the AHU (including cool stages and other dehumidification devices).

11.6.9 Curtailment

Some power companies offer curtailment programs that allow participating stores to disable user-defined loads during peak power times in return for discounts on utility rates.

If you are participating in a curtailment program, the power company will supply you with a digital curtailment device that must be wired to an input on the RS485 I/O Network.

To set up curtailment in the system software, you must designate which specific heating and cooling stages will be subject to curtailment.

When the power company sends a curtail command (i.e., the value of the curtailment device switches to "CLOSED"), all stages that are set up to be curtailed will be shut off and locked out.

Fan control is not directly affected by a call for curtailment. The AHU fan will still run at a speed based on the number of active, non-curtailed stages (or, if using modulated outputs, the curtailed modulating percentage). If this causes the fan to slow down or shut off during curtailment, there will be energy savings from the fans.

11.6.10 Optimum Start/Stop (OSS)



NOTE: OSS applies only to AHU Control applications that use a time schedule to change occupancy states. Overrides initiated by the digital BYPASS TO OCC or BYPASS TO UN-OCC inputs will not initiate pre-starts or pre-stops.

Optimum Start/Stop (OSS) is a feature that works alongside the AHU Control application's occupied and unoccupied temperature control modes. OSS takes control of heating and cooling several minutes before the building is scheduled to change occupancy states, and prepares the building for the upcoming change in setpoints. As a result, when the occupancy state changes, the temperature will be comfortably within the range of the new setpoint.

Figure 11-15 shows an example of how pre-starts and pre-stops work in a heating application. From unoccupied

mode, the pre-start period ramps the temperature up slowly so that when the scheduled change from unoccupied to occupied mode occurs, the temperature will already be at or near the occupied heating setpoint. During the pre-stop, which occurs before AHU Control goes from occupied to unoccupied mode, heating is suspended and the temperature is allowed to “coast” down to the unoccupied setpoint.

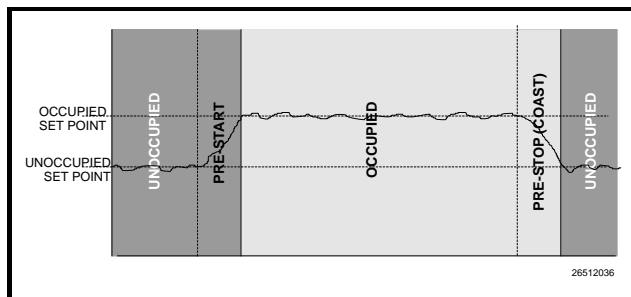

Figure 11-15 - Diagram of Pre-Start and Pre-Stop Operation
Intelligent Pre-Starts and Pre-Stops

OSS is designed to handle pre-starts and pre-stops in the most energy-efficient manner possible. Every time a pre-start or pre-stop occurs, OSS measures the amount of time it takes to bring the temperature from the previous setpoint to within the “comfort zone” of the new setpoint (a user-defined range of values above and below the setpoint within which the temperature is considered acceptable). This duration is used to determine the average rate of temperature change, called the K factor.

The K factor is stored in the memory along with the average value of the outdoor air temperature during the pre-start or pre-stop. Over time, collected K factor data will be sorted and combined into a table. As a result, by constantly observing and recording the results of previous pre-starts and pre-stops, OSS will be able to intelligently guess how much time a pre-start or pre-stop mode should last based on the outside temperature.

AHU Control keeps track of three different kinds of K factors:

- *Heat K factor* - used to guess pre-start durations for AHUs operating in heating mode.
- *Cool K factor* - used to guess pre-start durations for AHUs operating in cooling mode.
- *Coast K factor* - a measurement of the change in temperature when no heating or cooling is active. This is used to determine pre-stop durations for both heating and cooling AHUs.

11.6.11 Separate Setpoints

The Separate Setpoints strategy for AHU allows a Cut In/Cut Out setpoint to be set up for *each* heat and cool

stage instead of just one cool and one heat setpoint set up for each stage (Normal strategy). Dehumidification control can be performed while controlling with separate setpoints.

11.6.12 AHU Zone Control

Unlike MultiFlex RTU rooftop controller applications, AHU applications are not required to be grouped into Zone applications (AHUs are usually large enough to be “zones” in and of themselves).

However, if desired, you may associate an AHU Control application with a Zone application. The AHU will then use the Zone’s Temperature Control setpoints, occupancy state, summer/winter state, and economization and dehumidification enable signals. More information on Zone control is available in **Section 11.7, Zone Control**.

11.6.13 Hardware Overview

To set up an AHU for control by an E2, numerous temperature and humidity sensors for several different applications must be connected to the I/O Network, as well as fan and cool proof checking devices, economization checking devices, curtailment devices, and all of the heating, cooling, and dehumidification outputs.

Listed below are wiring instructions for some of the inputs and outputs that are part of a typical AHU setup.

Inputs	Sensor Type	Wiring Instructions
Space Temperature	Temperature	See Table 9-1 on page 9-3
Space Humidity	Humidity	See Table 9-1 on page 9-3
Supply Air Temp	Temperature	See Table 9-1 on page 9-3
Return Air Temp	Temperature	See Table 9-1 on page 9-3
Outdoor Air Temp	Temperature	Set up as Outdoor Air Provider in Global Data (see Section 10.17).
Outdoor Air Humid	Humidity	Set up as Outdoor Humidity Provider in Global Data (see Section 10.17).

Table 11-10 - Suction Group Inputs

Inputs	Sensor Type	Wiring Instructions
Curtailement Device	Digital	Set up as Curtailement in Global Data (see Section 10.17).
Fan Proof	Digital	See Table 9-1 on page 9-3
Fan Proof Reset	Digital	See Table 9-1 on page 9-3
VS Inverter Alarm	Digital	See Table 9-1 on page 9-3
Enthalpy Switch (Indoor and/or Outdoor)	Digital	See Table 9-1 on page 9-3
Dewpoint Probe (for Economization)	Dewpoint	See Table 9-1 on page 9-3
Mixed Air Temp (analog economizers only)	Temperature	See Table 9-1 on page 9-3

Table 11-10 - Suction Group Inputs

Output Device	Wire 8RO contacts to:	Set Fail-safe Dip Switch to:	Notes
Heat / Cool Staged Outputs	see note	see note	Set up any stages you want ON when the controller is off-line as N.C. Stages you want OFF should be set as N.O.
Single-Speed Fans	see note	see note	If one or more heat or cool stages will be ON, wire fan N.C. so it will be active during controller off-line times. Otherwise, wire N.O.
Two-Speed Fans (LOW, HIGH, and fan contactor)	see note	see note	If any heat or cool stages are configured to be ON (N.C.), set the wiring and the switch to N.C., and set either the LOW or HIGH stage output to N.C. (whichever speed you want active). If no heat or cool will be active, set LOW, HIGH, and the fan contactor to N.O.
Digital Economizer	N.O.	N.O.	

Table 11-11 - Suction Group Outputs

11.7 Zone Control

11.7.1 Overview

An **HVAC Zone** is a collection of up to sixteen rooftop units or air handling units that work together to maintain the same temperature and humidity throughout a particular volume of space. The primary function of an HVAC Zone is to “manage” the operation of each individual HVAC unit by providing the temperature setpoints that will be used in Temperature Control. Zones are also responsible for ordering HVAC units to dehumidify and determining

when outside air conditions are favorable to economize.

11.7.2 How Zones Work

A Zone is built by first creating a Zone application in the E2 BX. Then, all HVAC unit applications that will be a part of the Zone must be connected with the Zone application. This connection process is known as **association**.

When a rooftop unit or AHU is associated with a Zone, the E2 automatically makes a series of I/O connections between the Zone application and the individual MultiFlex RTU or AHU application. From that point on, the Zone is

responsible for passing along the following information to the individual unit:

- The heating and cooling setpoints it will use during occupied and unoccupied building times.
- A command to operate in either occupied or unoccupied mode (based on the Zone application's own time schedule input).
- Outdoor air and outdoor relative humidity values.
- A signal to enable or disable economization (based on the Zone application's own economization checking method).
- A signal to begin or end dehumidification (based on the Zone application's own humidity reading and dehumidification setpoint).
- A signal indicating the current season is either SUMMER or WINTER.
- The combined Zone Temperature and Zone humidity (based on a combination of each HVAC unit's space temperature and space humidity).
- The fallback temperature and humidity setpoints to use in case the unit loses contact with its Zone application.

11.7.3 Applications That May Be Connected To Zones

There are three different HVAC applications that may be associated with a Zone application: a MultiFlex RTU application, a MultiFlex RCB application, and an AHU application. The MultiFlex RTU and RCB applications interface with the MultiFlex RTU and RCB I/O Network boards that control rooftop units. AHU applications use input and output points on the I/O Network to control air handling units.

11.7.3.1 MultiFlex RTU Board

The MultiFlex RTU is a control board on the E2's I/O Network that controls the operation of a single rooftop HVAC unit. This board has an on-board processor with numerous inputs, relay outputs, and 0-10VDC analog outputs, and is designed for controlling advanced rooftop units with a large number of heat/cool stages, variable-position economizers, variable-speed fans, etc.

The E2's MultiFlex RTU applications serve only two purposes: to act as an interface between the user and the MultiFlex RTU processor, and to allow communications between the MultiFlex RTU board and the Zone application. The MultiFlex RTU depends on the Zone application to provide temperature setpoints, dehumidification and

economization enabling, and other information.

The MultiFlex RTU board also has the ability to act in stand-alone mode without help from the Zone application. The MultiFlex RTU has its own fallback temperature control strategy, and even has a seven-day fallback occupancy schedule that may be substituted when communications with the Zone is lost.

11.7.3.2 MultiFlex RCB Board

The MultiFlex Rooftop Control Board (RCB) (*P/N 810-3062*) is a rooftop HVAC control board for use either as a stand-alone controller or in zone control applications using a Retail Solutions E2 BX building control system. The MultiFlex RCB is capable of controlling heat and cool stages, fans, humidification and dehumidification devices, economizers using on-board I/O and control algorithms, as well as monitor and interact with other building control systems and peripherals (such as smoke alarms and CO2 sensors).

Differences Between the MultiFlex RCB and the MultiFlex RTU:

The RCB is an improved version of the MultiFlex RTU. The RCB has sixteen fully configurable analog and digital input points, whereas the RTU has only eight inputs, two of which are configurable. The RCB has four analog outputs for use in controlling variable speed fans, economizers or modulating heating and/or cooling valves, whereas the RTU has only two analog outputs for use only with VS fans and economizers. The RCB also features a more sophisticated HHT interface and updated algorithms for controlling heating, cooling, dehumidification, and air quality.

11.7.3.3 AHUs

An AHU controls all aspects of an air handling unit, including up to eight stages of auxiliary or reclaim heat, six cooling stages, dehumidification, analog or digital economization, and support for single-, two-, or variable-speed fans.

Normally, since AHUs are designed to cover a wide area of space, AHU Control applications operate on their own and are not associated with Zone applications (they are large enough to be "zones" within themselves). However, if desired, an AHU may be associated with a Zone application, which will allow the AHU to use the Zone's setpoints, occupancy state, summer/winter state, and dehumidification and economization enabling.

11.7.4 Temperature Control

As mentioned, Zone applications do not "control" temperature themselves. Zone applications simply pass along the setpoints an HVAC unit will use, and the individual unit is responsible for controlling to the setpoint using its

own temperature input.

The Zone application passes along eight different setpoints, which are shown in **Table 11-12**. Of these setpoints, the application receiving the setpoints will only use one cooling and one heating setpoint. The pair the application will use is determined by whether the current season is SUMMER or WINTER and whether the building is OCCUPIED or UNOCCUPIED (both of which is supplied by the Zone).

Cooling	Heating
SUMMER COOL OCC	SUMMER HEAT OCC
SUMMER COOL UOC	SUMMER HEAT UOC
WINTER COOL OCC	WINTER HEAT OCC
WINTER COOL UOC	WINTER HEAT UOC

Table 11-12 - Possible Heating/Cooling Setpoints

11.7.5 Zone Temperature

Each MultiFlex RTU and AHU application has a space temperature output that is equal to the unit's current Control Temperature. When associated with a Zone application, this space temperature output is connected to one of sixteen Zone Temperature inputs in the Zone application. These sixteen inputs are then combined using a user-defined combination method to yield the Zone Temperature.

Zone Temperature provides an at-a-glance view of how well the units within the Zone are doing in heating and cooling. If desired, Zone Temperature may also be used as a temperature control input by one or all of the Zone's HVAC applications.

11.7.6 Economizer Control

A Zone application is responsible for analyzing the outside air conditions and determining if the conditions are favorable for bringing in outside air. If the air condition is favorable, the Zone sends a signal to its associated HVAC units telling them economization is OK. If not, it sends a signal to disable economization.

It is up to the associated HVAC unit to process the economization information and open the dampers.

11.7.7 Economization Enable

There are five possible ways a Zone application may determine when conditions are favorable for economization:

1. **Enthalpy Switch** - An enthalpy switch is a digital device that is pre-set to detect when the temperature and humidity levels are favorable for economization. When the conditions are favorable, this

switch sends an OK (ON) signal to the Zone application. Otherwise, the switch sends a NOT OK (OFF) signal.

2. **Dewpoint Setpoint** - A dewpoint probe measuring the dewpoint of the outside air is compared to a setpoint. If the outside air dewpoint is less than the setpoint, economization is enabled. If it is higher than the setpoint, economization is disabled.
3. **Calculated Enthalpy** - The Zone application calculates the outside air enthalpy by reading the value of a relative humidity sensor and an outdoor air temperature sensor. This calculated enthalpy is compared to a setpoint. If the enthalpy is less than the setpoint, economization is enabled. If greater, economization is disabled.
4. **Dewpoint Fail-Safe** - This is similar to method #2, except an outdoor temperature sensor value is compared to the setpoint instead of a dewpoint probe's value. This comparison is a poor substitute for actual dewpoint readings and is recommended for use as a fail-safe only. When possible, use humidity or dewpoint sensors.
5. **Temperature Comparison** - The AHU Control application simply compares the temperature of the inside air with the temperature of the outside air. If the outside air is cooler than the inside air, economization is enabled.
6. **In vs. Out Enthalpy** - This strategy requires indoor and outdoor humidity sensors and also indoor and outdoor temperature sensors. The enthalpy of the outdoor air is calculated and compared to the enthalpy of the indoor air. If the outdoor air enthalpy is less than the indoor air enthalpy, economization is enabled. Otherwise, economization is disabled.

You may choose a different method for use in summer and winter months. Also, an alternate method may be specified that will be used as a fail-safe when the primary method is not available (due to sensor failure, etc.).

11.7.8 The Effect of Enabling Economization

Both MultiFlex RTU and AHU applications support the use of both two-position (digital) and variable-position (analog) economizers. Digital economizers, when enabled, behave like a first stage of cool. When analog economizers are enabled, the MultiFlex RTU or AHU will modulate the opening percentage of the dampers based on its own mixed air temperature measurements.

11.7.9 Dehumidification Control

A Zone application is responsible for reading the relative humidity level within the Zone, comparing it to a dehumidification setpoint, and sending a command to dehumidify when the humidity is above the setpoint.

Once the Zone humidity level rises above the setpoint, dehumidification will be active in all the Zone application's associated HVAC units until the indoor relative humidity falls below the setpoint minus the dehumidification hysteresis value. An example of this is shown in *Figure 11-16*.

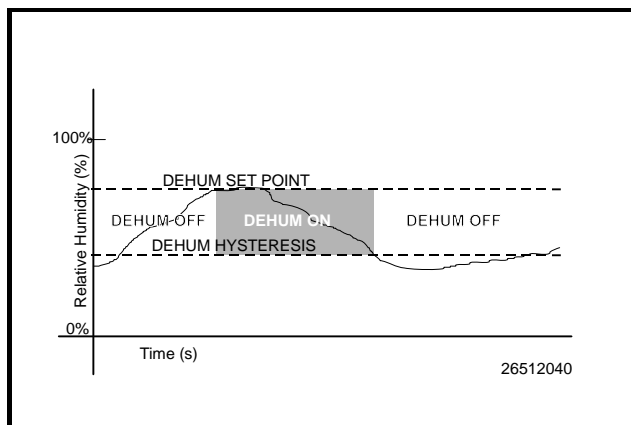

Figure 11-16 - Dehumidification Setpoint Control

The need for dehumidification may also be determined by a digital humidistat. In this case, dehumidification is active only when the humidistat input is ON.

11.7.10 The Zone Humidity Input

Note that unlike Zone Temperature, which has 16 inputs that combine into a single value, Zone humidity is designed to be provided by a single input. However, there may be some instances where one or more relative humidity sensors exist within a Zone (such as an installation where each MultiFlex RTU has its own humidity sensor for use in Stand-Alone mode). If you have multiple humidity sensors in a Zone and you wish to combine these humidity sensor values to calculate Zone Humidity, use an Analog Combiner application to make the combination,

and tie the Zone application's Zone Humidity input to the output of the combiner. Refer to **Section 11.18, Analog and Digital Combiners** for Analog Combiner application programming instructions.

11.7.11 The Effect of Enabling Dehumidification

When a Zone application determines that dehumidification is needed, it sends an ON signal to all its associated controllers, signaling them to begin dehumidification. It is up to the individual MultiFlex RTU, RCB, or AHU to perform the dehumidification.

11.7.11.1 MultiFlex RTUs and RCBs

Once the MultiFlex RTU and RCB applications acknowledge the signal to begin dehumidification, it will search its outputs for a dehumidification device. If one is configured, this device will be turned ON. Afterwards, cool stages will be cycled ON (up to a user-defined maximum number of stages) until all stages are ON or until the Zone application signals dehumidification is complete. When dehumidification is complete, the stages will cycle OFF followed by the dehumidification device.

11.7.11.2 AHUs

AHUs use a special dehumidification algorithm based on the Proportional loop in PID control. When dehumidification is enabled by the Zone application, the AHU application will activate a percentage of its total cool stage capacity, the amount of which depends on how close the current relative humidity is to the setpoint. See **Section 11.6, Air Handling Units (AHU)**, for more information.

11.7.12 Optimum Start/Stop (OSS)



NOTE: OSS applies only to Zone applications that use a time schedule to change occupancy states. Overrides initiated by the digital BY-PASS TO OCC or BYPASS TO UNOCC inputs will not initiate pre-starts or pre-stops.

Optimum Start/Stop (OSS) is a feature that works alongside the Zone application's occupied and unoccupied temperature control modes. OSS takes control of heating and cooling several minutes before the Zone application is scheduled to change occupancy states, and prepares the area for the upcoming change in setpoints. As a result, when the occupancy state changes, the temperature will be comfortably within the range of the new setpoint.

Figure 11-15 shows an example of how pre-starts and pre-stops work in a heating application. From unoccupied mode, the pre-start period ramps the temperature up slowly so that when the scheduled change from unoccu-

pied to occupied mode occurs, the temperature will already be at or near the occupied heating setpoint. During the pre-stop, which occurs before the Zone application goes from occupied to unoccupied mode, heating is suspended and the temperature is allowed to “coast” down to the unoccupied setpoint.

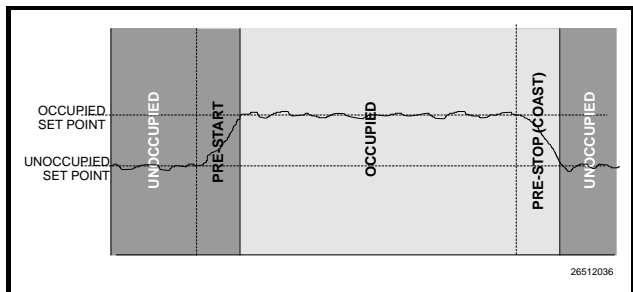

Figure 11-17 - Diagram of Pre-Start and Pre-Stop Operation

Intelligent Pre-Starts and Pre-Stops

OSS is designed to handle pre-starts and pre-stops in the most energy-efficient manner possible. Every time a pre-start or pre-stop occurs, OSS measures the amount of time it takes to bring the temperature from the previous setpoint to within the “comfort zone” of the new setpoint (a user-defined range of values above and below the setpoint within which the temperature is considered acceptable). This duration is used to determine the average rate of temperature change, called the K-factor.

The K-factor is stored in the memory along with the average value of the outdoor air temperature during the pre-start or pre-stop. Over time, collected K-factor data will be sorted and combined into a table. As a result, by constantly observing and recording the results of previous pre-starts and pre-stops, OSS will be able to intelligently guess how much time a pre-start or pre-stop mode should last based on the outside temperature.

AHU Control keeps track of three different kinds of K-factors:

- *Heat K-factor* - used to guess pre-start durations for AHUs operating in heating mode.
- *Cool K-factor* - used to guess pre-start durations for AHUs operating in cooling mode.
- *Coast K-factor* - a measurement of the change in temperature when no heating or cooling is active. This is used to determine pre-stop durations for both heating and cooling AHUs.

11.7.13 Losing Contact With Zone Applications

When a MultiFlex RTU or AHU loses contact with the Zone application to which it was assigned, it is forced to operate in Stand-Alone Mode. Each of the different applications have different stand-alone capabilities.

11.7.14 Stand-Alone MultiFlex RTUs

The MultiFlex RTU uses its own occupied and unoccupied heating and cooling setpoints when it operates in Stand-Alone Mode. These values are programmed through the MultiFlex RTU application and stored in the memory on the MultiFlex RTU board itself. During Stand-Alone Mode, the MultiFlex RTU uses its space temperature sensor value as the control input.





The MultiFlex RTU also has a seven-day fallback occupancy schedule that it may use to determine occupied or unoccupied building status. Different times may be programmed in the MultiFlex RTU application for Sunday through Saturday. Holiday scheduling is not supported.

Economization control is available if the sensor providing the economization checking is connected to an input on the MultiFlex RTU. Otherwise, economization is disabled.

As it does in Temperature Control, the MultiFlex RTU stores its own occupied and unoccupied dehumidification setpoints. If the MultiFlex RTU has its own humidity sensor, it will continue dehumidification using the stored fallback setpoints.

11.7.15 MultiFlex RTU/ARTC and AHU Zone Association

MultiFlex RTUs and AHUs are assigned to Zone applications using the Zone Association screen. To access this screen:

1. Press  for the Main Menu.
2. Press  for System Configuration.
3. Press  the Network Setup menu.
4. Press  for Associations.

11.9 MultiFlex PAK Board

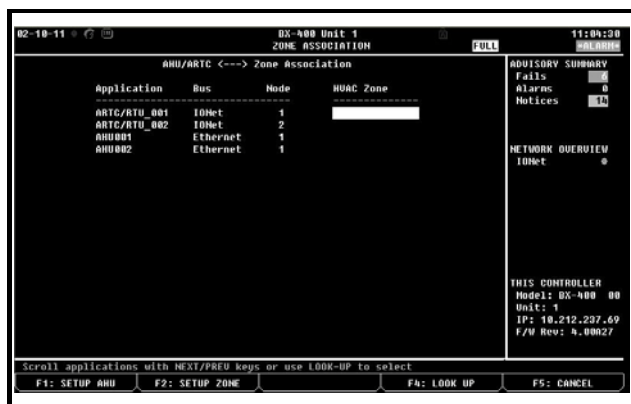

Figure 11-18 - Zone Association Screen (BX-400 Unit Shown)

The Zone Association screen lists all RTUs/ARTCs, and AHUs that are set up on the current E2. To make an association, move the cursor to the **HVAC Zone** field of the RTU/ARTC or AHU you wish to associate, and press **F4** (LOOK UP) to open the Application Selection menu and use the arrow keys to scroll to find the desired Zone name. When this menu is open, use **F3** and **F4** to move quickly to the beginning or end of the list respectively.

From this screen, you may also choose to jump to the Setup screen to configure an individual RTU/ARTC, AHU or Zone application by using the **F1** (SETUP AHU) key or the **F2** (SETUP ZONE) key.

11.8 MultiFlex CUB Board

The MultiFlex Condensing Unit Board (CUB) is a “smart” input/output board designed to control single condensing units. A single condensing unit is a self-contained compressor and condenser bearing unit which controls refrigeration in a single case line-up or walk-in cooler.

The MultiFlex CUB uses the same general hardware configuration as a MultiFlex 168AO. It is equipped with a processor and extra memory to allow it to control compressors, condensers, refrigeration, and defrost for a single condensing unit using on-board I/O and control algorithms.

The MultiFlex CUB has its own installation and operation manual, (P/N 026-1706).

The PAK is a distributed pack (rack) controller that controls compressors and condenser fans. The PAK can control up to 8 compressor groups containing up to 16 compressors. The compressor control strategy is Fixed Steps with setpoint/deadband using ON and OFF delays. Up to 20 Fixed Steps can be configured.

The PAK can control up to 4 condenser fan groups containing up to 8 total condenser fans. The PAK condenser control strategy is sequential TD control with setpoint/deadband using ON and OFF delays.

The PAK has a compressor/condenser interlock feature that will override TD control and force the condenser fans to stage off using the TD control OFF delay when all compressors are off. This feature can be disabled with an Enable/Disable setpoint or when the discharge pressure is above a configurable setpoint.

The MultiFlex PAK boards consist of two circuit boards: a bottom layer with 16 combination digital/analog inputs, and a plug-in top layer which contains a combination of 8 relay outputs and 4 digital DC voltage outputs.

The analog outputs on the Multiflex PAK drive solid state relays to control the fan stages. The relays control the compressor groups.

The communication interface is RS485 I/O using the Standard Extended Address Form for Retail Solutions Distributed Controllers. Currently, the PAK is designed to interface with the Retail Solutions Einstein and E2 controllers.

The MultiFlex PAK has its own installation and operation manual, P/N 026-1712.

11.10 Lighting Schedules

This section explains the function of E2’s Lighting Schedule application. It includes an overview of how the application works and instructions on how to program it.

11.10.1 Overview

The Lighting Schedule application provides an interface for Cut In/Cut Out control based on light level, simple time scheduling with or without use of external Time Schedule applications, proofing, minimum on/off times, solar control, and output dimming control.

Generally, the Lighting Schedule application is designed to follow a digital command from a time schedule to determine when the lights should be ON or OFF. At the same time, Lighting Schedule looks at the value of a light level sensor, compares it to a set of Cut In/Cut Out

setpoints, and overrides the schedule as the real-time lighting conditions warrant. As a result, the light level sensor and schedule both work to provide adequate light when

needed AND saving energy by keeping lights OFF when they are not necessary.

11.10.2 Functions of the Lighting Schedule Application

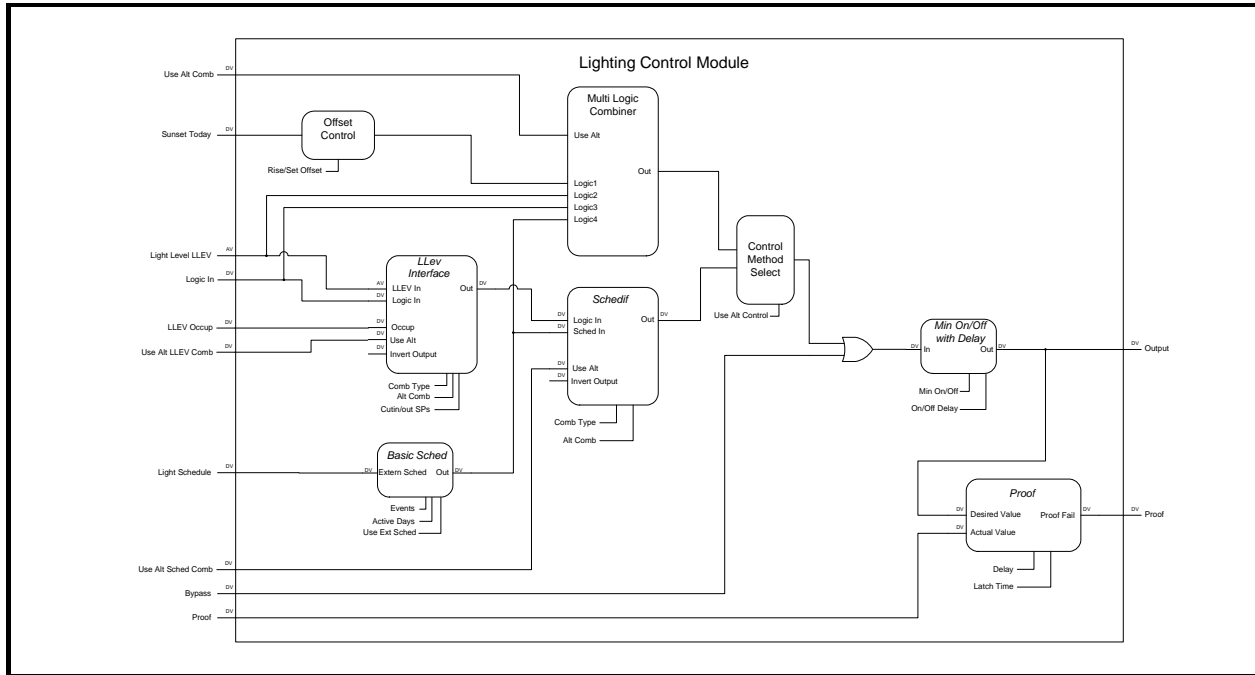

Figure 11-19 - Lighting Schedule Module Cell Diagram

Figure 11-19 shows a flowchart diagram of the Lighting Schedule application and the eight cells that work together to control the lights. A description of each cell and the functions they perform are given below.

11.10.3 Control Method Select

Control Select determines whether the Multi-Logic Combiner is used *or* the Light Level Interface and Schedule Interface are used for Lighting Control. When **Use Alt Control** is set to **Yes**, the Light Level Interface and Schedule Interface combination strategies are disabled and are not visible. When **Use Alt Control** is set to **No**, the Multi-Logic Combiner matrix is disabled and not visible.

11.10.4 Standard Control

Standard control comprises Light Level Interface and Schedule Interface strategies.

11.10.4.1 The Light Level Interface Cell (LLEV INTERFACE)

The Light Level Interface cell of the Lighting Schedule application translates the value of the light level sensor into an ON or OFF command by comparing the analog

light level to a set of Cut In/Cut Out setpoints.

From an OFF state, when the light level falls below the Cut In setpoint, the result of the light level comparison will be an ON state. When the light level rises above the cut-out setpoint, the state will transition from ON to OFF.

The ON/OFF state determined by the light level can be logically combined with LOGIC IN, a digital input from an input point or another application in E2. The result of this comparison will be the final ON/OFF light state command that is sent from the Light Level Interface cell to the Schedule Interface cell (explained below).

Logical Combination Strategies

There are several different strategies for combining the light level ON/OFF state with the value of the LOGIC IN input:

- *Logic Only* - The cell will read only the LOGIC IN input and ignore the light level sensor reading.
- *LLEV Only* - The cell will read only the light level sensor and ignore the value of the LOGIC IN input.
- *Both ON/Both OFF* - From an output=OFF

state, when both the light level state and the LOGIC IN input are ON, the resulting output command will be ON. The output command will remain ON until both the light level state and the LOGIC IN input turn OFF.

- *Both ON/LLEV OFF* - Like the Both ON/Both OFF strategy, except only the light level state must turn OFF in order to turn the output from ON to OFF.
- *LLEV ON/Both OFF* - Like the Both ON/Both OFF strategy, except only the light level state must turn ON in order to turn the output from OFF to ON.
- *Both ON/Any OFF* - Like the Both ON/Both OFF strategy, except any of the two states that turn from ON to OFF will result in the output turning OFF.

The LOGIC IN input should not be used to compare the light level state to a Time Schedule output or a similar digital state that represents OCCUPIED/UNOCCUPIED. Schedule comparisons are handled by the Schedule Interface cell. If a schedule input value is the only digital value you will be using to combine with the light level sensor value, choose the “LLEV ONLY” combination for this cell.

Occupied/Unoccupied and Alternate Settings

If desired, the Light Level Interface cell can be set up with a set of unoccupied Cut In/Cut Out setpoints. To do this, the Light Level Interface cell relies on a separate digital input to tell it when to use occupied or unoccupied setpoints.

The Light Level Interface cell can also be set up with a set of alternate occupied and unoccupied setpoints, used only when the value of the input called USE ALT LLEV COMB is ON.

11.10.4.2 The Schedule Interface Cell (SCHEDIF)

The Schedule Interface cell is similar in function to the Light Level Interface cell, except it is used to logically combine the output of the Light Level Interface cell with that of the Basic Schedule cell. The Schedule Interface cell allows you to choose how the light level sensor and the time schedule work together to control the lights.

Logical Combinations

The output of the Schedule Interface cell represents the final ON/OFF state of the lights. It determines this state by performing one of the logical combinations listed below:

- *LLEV/Logic Only* - The Schedule Interface cell uses the input from the Light Level

Interface cell as its output, ignoring the value passed to it from the Basic Schedule cell.

- *Sched Only* - The Schedule Interface cell uses the input from the Basic Schedule cell as its output, ignoring the value passed to it from the Light Level Interface cell.
- *Both ON/Both OFF* - From an output=OFF state, when both the Light Level Interface input and the Basic Schedule input are ON, the resulting output command will be ON. The output command will remain ON until both the Light Level and Basic Schedule inputs turn OFF.
- *Both ON/Sched OFF* - Like the Both ON/Both OFF strategy, except when the Schedule Interface output is ON, it will turn off only when the Basic Schedule input turns OFF.
- *Sch ON/Both OFF* - Like the Both ON/Both OFF strategy, except when the Schedule Interface output is OFF, it will turn ON only when the Basic Schedule input turns ON.
- *Both ON/Any OFF* - Like the Both ON/Both OFF strategy, except when the Schedule Interface output is ON, it will turn OFF if any input turns OFF.

If desired, the final result of any of the above combinations can be inverted by setting a parameter.

Alternate Schedule Interface Combinations

If desired, you can specify an alternate means of combining the Schedule Interface cell inputs that is used only when the Use Alt Sched Comb input is ON.

11.10.5 Alternate Control

Alternate control comprises Multi-Logic Combiner and Offset Solar Control strategies.

11.10.5.1 Multi-Logic Combiner

When the Alternate Lighting Control (**Use Alt Control**) parameter under the General tab in Setup of the application is set to **Yes**, an alternate lights on/off combination method is then used to turn lights ON and OFF. The user is then presented with a logical matrix where they can select which inputs will turn lights ON and OFF. This matrix is located under the Alt Control tab in Setup of the application.

The Number of Inputs parameter (**Num Inputs**), located under General tab in Setup of the application, specifies the number of input sources made available in the matrix. Up to four input sources may be used: Schedule, Solar, Light Level, and Logic.



TIP: *Activating the Use Alt Control parameter is the only way to use the Solar Calculation Control method for Lighting Control.*

11.10.5.2 Offset Solar Control

The Offset Solar Control cell of the Lighting Schedule application uses the Sunrise Offset and Sunset Offset parameters to determine how many minutes before or after sunrise the sun is considered to be risen, or how many minutes before or after sunset the sun is considered to be set. The resulting offset for sunrise and sunset is used by Lighting Control in its logical equations for the Solar state.

A positive value is entered if adding to the sunrise time, and a negative value entered if offsetting the sunrise to an earlier time. For example, if the user wanted to turn the lights OFF one hour before sunrise, Sunrise Offset would be set to **-60**, and if the user wanted to turn the lights ON 45 minutes after sunset, Sunset Offset would be set to **45**.

11.10.6 The Basic Schedule Cell

The Basic Schedule cell has two main functions:

- If a Time Schedule application is set up in E2 to provide ON/OFF times for the lights, the Basic Schedule cell passes the occupied/unoccupied state from this time schedule to the Schedule Interface or Multi-Logic Combiner cell.
- If no Time Schedule application is set up in E2 for light scheduling, the Basic Schedule allows you to configure a schedule for the Lighting Schedule application. This custom schedule will pass along a digital occupied/unoccupied state to the Schedule Interface or Multi-Logic Combiner cell.

If an external Time Schedule will be used, you will only need to configure the Basic Schedule by linking the schedule output to the input of the Basic Schedule cell and setting the Use External Schedule parameter to “Yes.”

If no external Time Schedule is being used, you may configure a set of schedule events and date ranges to be used by the Lighting Schedule application. Up to 15 ON/OFF schedule events can be programmed, as well as up to 12 date ranges.

Schedule events and date ranges programmed into the Basic Schedule cell are used only by the Lighting Schedule application. If more than one Lighting Control application will be using the same schedule, it is recommended you configure an external Time Schedule application so you won’t have to re-enter event and date information for each lighting application.

11.10.6.1 Slave Scheduling

If you have an external Time Schedule application providing occupied/unoccupied times, but you want to alter this schedule slightly for the Lighting Schedule application, you can designate the Basic Schedule cell’s schedule as a **slave schedule**.

A slave schedule differs from a master schedule in that its events are relative to the events of a master schedule. A master schedule’s events are absolute times (like 08:00 ON, 23:00 OFF). A slave schedule contains a set of times that are added to or subtracted from its master schedule’s events (like +00:30 ON, -01:00 OFF). As a result, the behavior of the output of the slave schedule is altered slightly from that of the master schedule.

Slave scheduling is most often used in cases where the master schedule represents the occupied/unoccupied times of a building, and slave schedules are used to control loads that need activation or deactivation earlier or later than the occupied/unoccupied times.

11.10.7 The Min ON/OFF Cell

The Minimum ON/OFF cell has three important functions:

- It receives the light state requested by the Schedule Interface cell, and applies this state to a set of minimum ON and OFF times. If the requested light state turns ON the lights before the prescribed minimum ON time, or turns OFF the lights before the prescribed minimum OFF time, the Minimum ON/OFF cell will delay the command until the minimum ON or minimum OFF time has elapsed.
- If ON and OFF delays are specified, the cell delays ON/OFF commands it receives from the Schedule Interface cell.
- It processes commands for manual bypassing of the light state. When the Bypass input is any value other than NONE, the cell ignores the light state command input, all minimum ON/OFF times, and all ON/OFF delays, and bypasses the light state to the digital value of the Bypass input.

The digital output of this cell controls the I/O board output point that activates and deactivates the lights.

11.10.8 The Proof Cell

The Proof cell verifies that the lights are turning ON and OFF as commanded by the Lighting Schedule application. The Proof cell compares the digital command sent to the I/O output that controls the lights with a digital input from a proof checking device (like a digital light level sensor). If the two inputs are not equal for an amount of time

longer than the programmed proof delay, the Proof cell turns its Proof output ON to signify a failure has occurred.

The Proof cell will deactivate the Proof output if the proof failure has been cleared longer than the programmed proof latch time.

11.10.9 Output Light Dimming

The dimming feature allows the lighting output to be varied based on a light level sensor. Dimming capability can work with both Standard Control and Alternate Control configuration. For setup, the user can:

- Specify the light levels for the minimum and maximum light output.
- Specify the ramp speed that the indoor lighting output changes.

11.11 Demand Control

Demand Control applications are used by E2 to keep the total power usage of the building environmental system below a specific demand setpoint dictated by the power company. Demand Control applications achieve this by reducing power consumption in one or more applications in the other E2 applications as necessary until the total KW is below the setpoint. This process is called load shedding.

The Demand Control application is designed to calculate power usage in much the same way power companies do, which ensures that it will be able to meet the power company's demand limit accurately. The Demand Control application is also designed with a large amount of flexibility in the way load shedding is prioritized, which allows users to maximize power economization with a minimal amount of interference into the normal operations of the building's HVAC systems.

11.11.1 Introduction to Demand Limit Control

Power companies supply power to consumers at a fixed rate per kilowatt hour until a pre-defined level of energy consumption is reached. This level is called the **demand limit**. When the demand limit is exceeded, the rate is greatly increased as a penalty for high power demand by the consumer. Typically, once the demand limit is exceeded, the increased rate is charged for the remainder of the year.

To determine if a consumer has reached the demand limit, the power company arbitrarily monitors a consumer's energy consumption for a fixed period of time (usually anywhere from 15 to 30 minutes with most power companies, although it may be as short as 5 minutes). This

monitoring period is called the **demand window**. Demand windows are always the same length of time, but they may be measured at any time the power company chooses to.

Since Demand Control applications have no way of determining when the power company will start a demand window, they simply assume that the demand window can begin at any time. As new values of the KW input are gathered, Demand Control applications "roll" their demand windows forward and recalculate their load shedding algorithms as if the power company were measuring the average power of the new window.

For example, if the power company's demand window lasts for 15 minutes, the Demand Control applications will keep a constant real-time average of all recorded KW values from the previous 15 minutes. If a Demand Control application determines from its calculations that the current KW usage might cause its demand limit to be exceeded for the current or a future demand window, it will begin shedding loads to bring the KW usage down. A graphic example of the "rolling demand window" used by the Demand Control application is shown in *Figure 11-20*.

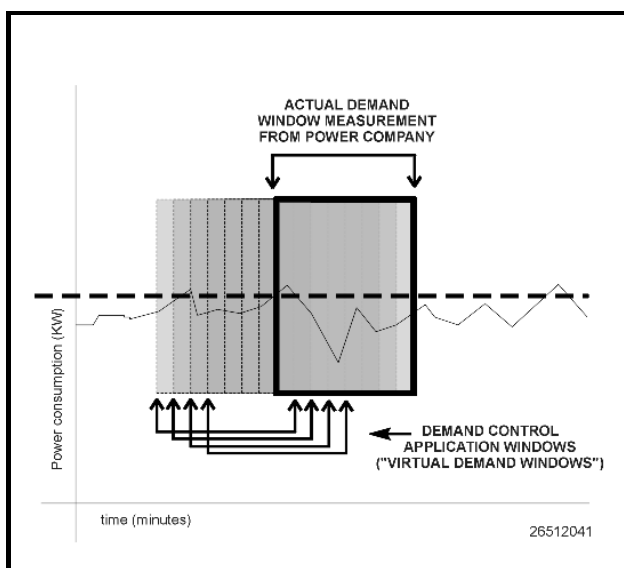

Figure 11-20 - Example of "Rolling Demand Window"

In short, the primary goal of a Demand Control application is to make sure that every possible interval of time that might be used by the power company as a demand window will be under the set demand limit. This ensures the demand setpoint will never be exceeded.

11.11.2 Demand Monitoring

The E2 either monitors power using an analog KW transducer (which sends the current KW usage via analog signal), or monitors energy consumption using a digital watt-hour transducer (which pulses to signify a fixed amount of watt-hours have been used).

As mentioned in **Section 11.11.1, Introduction to Demand Limit Control**, all KW input values are gathered together and averaged together in a demand window. The demand setpoint is then subtracted from this average. The result of this calculation is called the **integral error** (or **integral**) of the demand window. The integral error represents how far below or above the setpoint the input has been for the entire demand window.

Under non-demand conditions, the integral error will be below zero, since the average KW or watt-hour value will be below the setpoint.

The current value of the integral error and the current value of the KW input are what determine when the Demand Control application will begin load shedding.

11.11.3 Load Shedding

11.11.3.1 Definition

Load shedding is the process of curbing the amount of kilowatt usage within one or more target applications. Most applications that drive mechanical or electronic devices, such as lights, heaters, air conditioners, compressors, etc., are configured with special inputs that, when active, “shed” the application.

Physically, when a device is “shed,” its control setpoints are altered by a specified amount in a direction that will save energy. For instance, an HVAC unit with heating and cooling stages that is commanded to shed will have its heating setpoints lowered and its cooling setpoints raised. This will cause the HVAC unit to operate at a lower capacity, thus saving energy.

Table 11-13 lists a number of E2 RX-300 and BX-300 applications and how load shedding affects them.

Application	Shedding Effect
All HVAC applications (RT-100s, Multi-Flex RTUs, AHUs, Heat/Cools)	Raises cooling setpoints, lowers heating setpoints
Sensor Control and Analog Input I/O Modules	Raises or lowers Cut In/Cut Out setpoints (whichever direction saves energy)
Refrigeration Circuits	Raises case temperature setpoints
Suction Groups	Raises suction setpoint
Condenser	Raises discharge setpoint
Analog Output I/O Modules	Raises or lowers PID setpoint (whichever will save energy)
Digital Output I/O Modules	Control output is locked OFF.

Table 11-13 - Shedding Effect on Applications

11.11.4 Shedding Levels

Some applications have a single input (usually called DEMAND SHED) that, when ON, sheds the application. Each application is programmed with a specific “demand bump” value that is added or subtracted from the control setpoints when this input comes ON.

Other applications, notably HVAC applications, have two inputs: a primary and a secondary (usually called PRI DEMAND SHED and SEC DEMAND SHED). Each input has its own “demand bump” value, so that when the primary is ON, the primary demand bump is in effect, and when the secondary is ON, the secondary demand bump is in effect. When both of these inputs are ON, the demand bump values are added/subtracted together and applied to the setpoint(s). As a result, two levels of shedding are possible for a single application.

Example: An air conditioner with a cooling setpoint of 70°F has a primary demand bump value of 2 and a secondary demand bump value of 2. In a typical Demand Control application setup, the PRI DEMAND SHED input would be one of the first inputs to go into shed; when this occurs, the bump value is added to the cooling setpoint, raising it to 72°F.

The SEC DEMAND SHED would be set up to shed later (if necessary) as a second level of shedding for the air conditioner. When this input is turned ON, the setpoint is raised by the secondary demand bump value. Since the PRI DEMAND SHED input is still ON, both values are added to the setpoint, raising the setpoint to 74°F.

11.11.5 Priority Levels

Each application that you wish to set up for shedding must be assigned a priority level in the Demand Control application. When a Demand Control application sheds loads, it does so by shedding all applications that are in the first priority level, and then continuing to shed higher priority levels until the demand is at an acceptable level or until all levels are shed.

Priority levels are simply outputs that connect to the demand shedding inputs of one or more applications. When a level is shed, the output comes ON and all applications connected to the output are shed.

There are three types of priority levels:

1. First Shed

First Shed levels are the first ones to be shed when demand shedding begins. The Demand Control application first begins shedding by activating level #1 of the First Shed levels. As needed, each level thereafter is shed in succession (#2, #3, and so on to #20).

Applications that are part of the First Shed priority levels should be non-vital applications that would have no

significant effect on the system if it were to be shed for a prolonged period of time. Examples: motor room exhaust fans, satellite HVAC units and/or lights in low-occupancy rooms.

2. Rotational Shed

The Rotational Shed levels are shed in sequence only if all defined First Shed levels have already been shed and the Demand Control application needs more shedding to lower demand.

Unlike the First Shed priority levels, Rotational Shed levels do not always begin shedding by activating level #1. Instead, it shares the burden of being the first to activate among all the Rotational Shed levels. If, during one demand condition, Rotational Shed level #1 is the first of all the Rotational Shed levels to activate, it “rotates” first activation status to the next level in sequence (in this case, level #2). Thus, the next time a demand condition occurs, level #2 will activate first, and further levels will activate in sequence until it reaches level #1, which will be the last to activate.

Applications that are Rotational Shed priority should be more vital to system performance than the ones configured as First Shed priority levels. In addition, all applications assigned to Rotational Shed levels should all be of relatively equal importance, since they each will spend about the same total amount of time in shed.

Also, if you will be shedding a small amount of loads that are relatively equal in priority, you may choose to define them all under Rotational Shed levels, leaving the First Shed levels blank. Demand Control would then skip directly to the Rotational Shed levels during load shedding, and all loads would share shed time equally.

3. Last Shed

The Last Shed priority levels are shed in sequence only if all First Shed and Rotational Shed levels have been shed and the Demand Control application still requires demand reduction.

Like the First Shed priority levels, level #1 is always the first Last Shed level to be activated, followed by #2, #3, #4, and so on up to #20.

Applications that are assigned to this priority should be the most vital applications to system performance. These applications will be shed only as a last resort, and therefore will spend the least amount of time in shed.

A diagram of how Demand Control cycles through all of the three different types of priority levels are shown in the diagram in *Figure 11-21*.

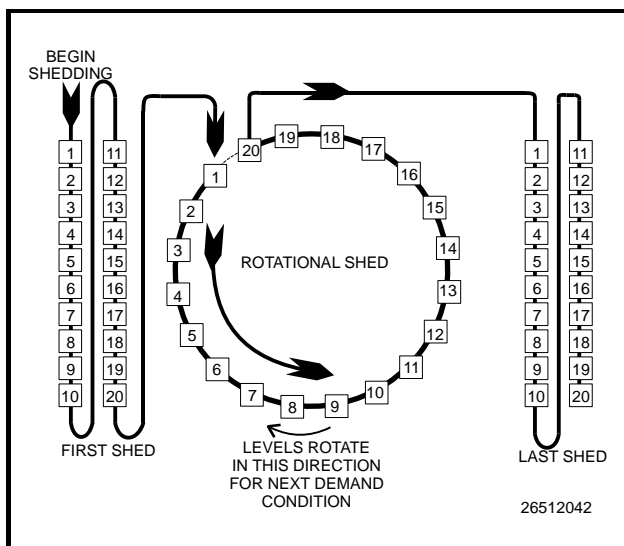

Figure 11-21 - Shedding Priority Levels

Other Notes About Priority Levels

All priority levels, whether they be First, Rotational, or Last, should be shedding relatively the same number of kilowatts. When the Demand Control application is shedding in a non-emergency situation, it usually sheds one or two levels at a time. Therefore, Demand Control would do a much better job of reducing demand quickly if each activated level were reducing the KW by an equivalent amount.

Also, each priority level has three important user-definable parameters that affect the level's time in shed:

- *Minimum Shed Duration* - the minimum amount of time a level must remain in shed. Demand Control will not restore the level until this minimum time has passed.
- *Maximum Shed Duration* - the maximum amount of time a level will remain in shed. When the level has been shed longer than this duration, it will automatically be restored regardless of the current need for demand shedding.
- *Minimum Restore Duration* - the minimum amount of time a level must be restored from shed before it may be shed again. Demand Control will not re-shed this level until this minimum time has passed.



NOTE: If a level is in **RESTORE** but its **minimum restore duration** has not been met, levels of the next highest priority category or categories will not be shed until the lower priority levels are all in shed.

11.11.6 How Demand Control Uses Load Shedding

Demand Control uses three parameters to perform load shedding: the current KW input value, the current integral error (described in **Section 11.11.2, Demand Monitoring**), and the active KW setpoint. The active setpoint is chosen from four different setpoint values depending on the season (summer or winter) and occupancy (occupied or unoccupied).

The Demand Control application is programmed with three different “modes” of operation. Under normal conditions, Demand Control operates in the first mode, then proceeds to the second or third mode if the demand is not adequately lowering.

Mode 1: KW Input Is Greater Than Setpoint

Mode 1 is usually the first stage of demand shedding used by Demand Control. It begins when the KW input rises above the setpoint.

When this occurs, Demand Control begins by shedding one level at a time, starting with First Shed #1, and continuing sequentially through all First, Rotational, and Last levels (as shown in **Figure 11-21**).

The Demand Control application will continue to shed levels in this sequence until the KW goes below the setpoint minus a user-defined hysteresis value and the integral error is less than zero. When both these conditions are met, the shed levels will be restored in last-shed-first-restore order.

Mode 2: KW Input Has Been Greater Than Setpoint for 1/4 Demand Window And Is Still Going Up

Mode 2 begins when the KW input has been above the setpoint for an amount of time equal to 1/4 the demand window duration, and the KW input has not begun to come down. In short, if Mode 1 is not working to lower demand, Mode 2 will take over.

When Mode 2 begins, Demand Control sheds two levels at a time, using the same sequence of priorities as Mode 1. Demand Control continues to shed in this manner until the KW goes below the setpoint minus a user-defined hysteresis value and the integral error is less than zero. When both these conditions are met, the shed levels will be restored in last-shed-first-restore order.

Mode 3: Integral Error Approaching Zero

If the integral error is getting too close to zero, this signifies the demand window may soon be above the power company’s demand setpoint. When this occurs, Demand Control switches to Mode 3.

Mode 3 simply calculates the amount of KW difference between the current KW input and the setpoint, and sheds enough levels to meet or exceed the KW shedding

requirement. Demand Control does this by reading the KW levels of all applications (which have been defined by the user when the applications were set up) in all the priority levels that have not yet been shed. It then sheds as many levels as necessary to bring the KW input value down (thus saving the demand window from exceeding the setpoint).

Note that though each application has a user-defined Application KW parameter that represents how much total power the application uses, the actual amount of KW used by the application may be significantly lower (especially if it is OFF when Demand Control sheds it). Demand Control compensates for this fact by assuming shedding an application will only lower the KW input value by 75% of the application’s designated KW value. For example, if a priority level contains a single AHU with a user-assigned KW value of 250, Demand Control will only expect to save 75% of this value (187.5 KW) by shedding it.

Example of a Mode 3 operation: A Demand Control application reads an integral error near zero and a KW input 300 KW above the setpoint. Mode 3 begins by determining how many levels it will need to shed to bring the KW input down to the setpoint.

First, since Demand Control assumes it will only save 75% of an application’s KW rating by shedding it, the application determines that it must shed 400 KW worth of levels to achieve the setpoint.

Second, Demand Control looks at all the applications in the next few priority levels (assume for purposes of this example that all First and Rotational Shed levels are already shed, and there are six defined Last Shed levels). The applications in the remaining levels are as follows:

Last Shed 1: Total 80 KW

Last Shed 2: Total 90 KW

Last Shed 3: Total 75 KW

Last Shed 4: Total 80 KW

Last Shed 5: Total 95 KW

Last Shed 6: Total 75 KW

Mode 3 will immediately shed stages 1, 2, 3, 4, and 5 for a total of 420KW. If 75% of this total is actually saved by this action, the total KW reduction will be 315 KW, which will bring the input 15KW below the setpoint.

After Mode 3 makes its emergency adjustment, Demand Control will recalculate. If the KW input is still above the setpoint and the integral error is still near zero, it will make another Mode 3 adjustment. If the KW is below the setpoint but not below the setpoint minus the user-defined hysteresis value, it will go back to operating in Mode 1 (shedding levels sequentially). If the KW is below the setpoint minus the hysteresis value and the integral error is below zero, Demand Control will begin restoring

loads.

11.11.6.1 Power Monitoring Input

The Input Type Selection parameter defines the way the Power Monitoring input (**INPUT** under the Inputs tab in application Setup) will be used. The parameter can be set to: **KW Analog**, or **Pulse KWH**.

Settings

When **KW Analog** is selected, verify the input is connected to a board and point that is set up with Engineering Units of KW. When **Pulse KWH** has been selected, verify the input is connected to a board and point that is set up with Engineering Units of KW.

11.12 Sensor Control

11.12.1 Overview

The E2 is equipped with numerous generic control modules that may be used both for simple monitoring of an analog or digital sensor and for simple Cut In/Cut Out control of a digital output. These modules are called Sensor Control modules.

There are two different Sensor Control Module types. **Analog Sensor Control modules** read the values from one or more analog sensors, compare them to a set of Cut In/Cut Out setpoints, and operate a digital output (such as a relay) based on the analog input in relation to the setpoints.

Digital Sensor Control modules read the values from one or more digital sensors, combine them using a series of logical commands, and operate a digital output (such as a relay) based on the result of the logical combination.

11.12.2 Analog Sensor Control

On a basic level, an Analog Sensor Control module performs three functions:

- **COMBINER:** Up to four analog inputs are combined into a single analog value.
- **CUT IN/CUT OUT CONTROL:** The combined input value is compared to a Cut In/Cut Out setpoint. Based on this comparison, a digital output will be turned ON or OFF.
- **ALARMING:** Alarms and notices can be generated based on the combined value of the inputs and its relation to a set of high and low alarm and notice setpoints.

11.12.3 Cut In/Cut Out Setpoint Control

Cut In/Cut Out setpoints work differently depending upon whether the Cut In/Cut Out setpoint is higher.

Cut In Higher Than Cut Out

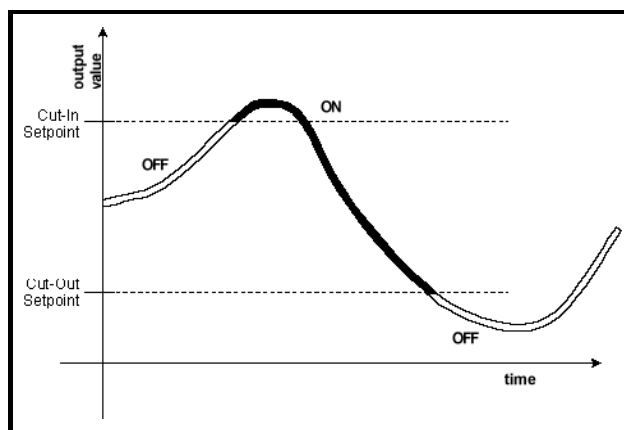

Figure 11-22 - Cut In Setpoint Higher than Cut Out

When the Cut In setpoint is higher than the Cut Out setpoint, the Sensor Control output turns ON when the sensor input goes higher than the Cut In setpoint. The Sensor Control output remains ON until the input falls below the Cut Out setpoint, at which time the output turns OFF. (See *Figure 11-22* for an illustration).

Cut/In Lower Than Cut/Out

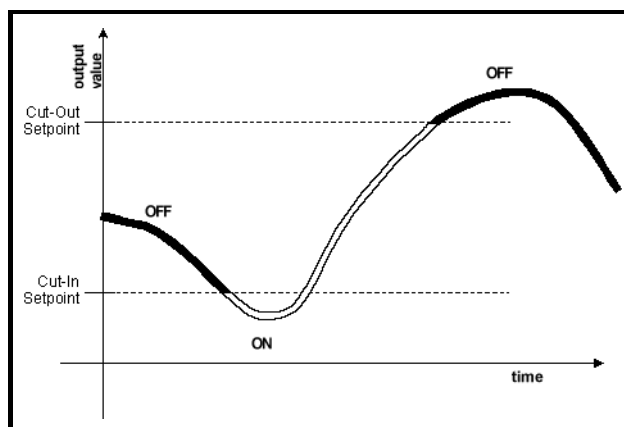

Figure 11-23 - Cut/In Setpoint Lower Than Cut/Out

When the Cut In setpoint is lower than the Cut Out setpoint, the Sensor Control output turns ON when the sensor input goes lower than the Cut In setpoint. The Sensor Control output remains ON until the input rises above the Cut Out setpoint, at which time the output turns OFF. (See *Figure 11-23* for an illustration).

11.12.4 Digital Sensor Control

The Digital Sensor Control module performs three

basic functions:

- **LOGICAL COMBINATION:** Up to four inputs may be combined using standard logical combination methods (such as AND, OR, XOR, etc.) The result is the **command output value**, which can be used to operate a relay.
- **BYPASS:** The command output may be configured to be bypassed to a fixed value by a switch or button press.
- **ALARMING:** Alarms and notices can be generated based on the command value of all the digital inputs of the cell, plus occupancy, and schedules.

11.12.5 Logical Combination

A Digital Sensor Control module has four inputs numbered 1 through 4. The logical combination of the Digital Sensor Control modules follows one of the following strategies:

- **FIRST** - The first of the four digital inputs received will be used as the logical input value. This combination first looks at input #1. If the value of this input is undefined, it looks for other valid inputs, starting with #2 and descending in numerical order to #4.
- **SELECT** - The sensor module reads an analog input, which provides a numerical value from 1 to 4. This number determines
- **AND** - The logical input value will be ON only when all sensor control inputs are ON. If one or more of them are OFF, then the logical input value will also be OFF.
- **OR** - The logical input value will be ON if one or more sensor control inputs are ON. If all of them are OFF, the logical input value will also be OFF.
- **XOR** - This combination strategy is exactly the same as OR, except when all sensor control inputs are ON, the logical input value will be OFF instead of ON.
- **VOTE** - If more than half of the sensor control inputs are ON, the logical input value will be ON. Otherwise, if 50% or less of the sensor control inputs are OFF, the logical input value will be OFF.

11.13 Loop/Sequence Control

The Loop Sequence Control application's main function is to read the value of an analog input, compare the

value to a setpoint, and generate a single analog output value. This output value is represented in three different forms: a single analog value from 0% to 100%, up to eight digital stage outputs, and a digital pulse width modulation output.

The output value(s) are generated by a PID Control cell, which takes into account both the input's instantaneous value and its rate and direction of change. The PID Control algorithm is similar to the PID algorithm used by Pressure Control, except the Loop Sequence Control application is designed to be used in a wider array of applications.

11.13.1 Layout of the Loop/Sequence Control Application

There are two different types of cells in the Loop/Sequence Control Application: control cells and output cells. The control cells have a part in determining the PID output percentage. The output cells convert this PID percentage to staged digital and pulse width modulation activations.

11.13.1.1 Control Cells

The five control cells in the Loop/Sequence Control application act as "steps" in determining the final PID percentage.

Step 1: Select - The Select cell determines whether the occupied setpoint or the unoccupied setpoint will be used by the PID cell. This cell reads in values for both setpoints, chooses the one to use based on the value of an Occupancy input, and sends the appropriate setpoint value to the next cell in line, the Setpt Float cell.

Step 2: Setpt Float - The Setpt Float cell allows alteration of the control setpoint provided by the Select cell based on comparison of a "float" input to a range of values. The floating setpoint is then sent to the next cell in line, the PID Control cell.

Step 3: PID Control

This cell makes the PID percentage calculation based on the value of the setpoint (received from the Setpt Float cell) compared to the control input, which is fed directly into the PID Control cell. The resulting percentage is sent to the next cell in line, the Filter cell.

Step 4: Filter - The Filter cell limits the rate of change of the PID percentage over time, and is typically used to keep the PID cell from over-compensating when inputs change drastically. The filtered PID percentage is sent to the final control cell, the Override cell.

Step 5: Override - Once the PID percentage is figured, the Override cell provides for overrides of the PID percentage. The Override cell, when activated by a user-initiated manual override, will block the PID percentage from

being sent to the outputs, replacing it with a fixed value specified by the user.

The value from the Override cells is then sent to the Loop/Sequence Control's PID output, and also to the two output cells for conversion to stages and PWM.

11.13.1.2 Output Cells

The two output cells make no alteration of the PID percentage determined by the control cells, but re-interpret them in a way that can be used for systems with multiple stages and/or with pulse width modulation.

Sequencer - The Sequencer cell will use the percentage to activate an equivalent percentage of its defined

stage outputs. The Sequencer supports up to eight cells, and also provides for minimum on/off times and first-on/last-off sequencing.

PWM - The PWM cell drives a digital output whose ON time per pulse width modulation period is equal to the PID percentage. In other words, if the PWM cell is set with a pulse width of 10 seconds, a PID percentage of 60% turns the output ON for 6 seconds, OFF for 4 seconds, ON for 6 seconds, etc.

11.13.1.3 Diagram

An abstract diagram of the control and output cells is shown in *Figure 11-24*.

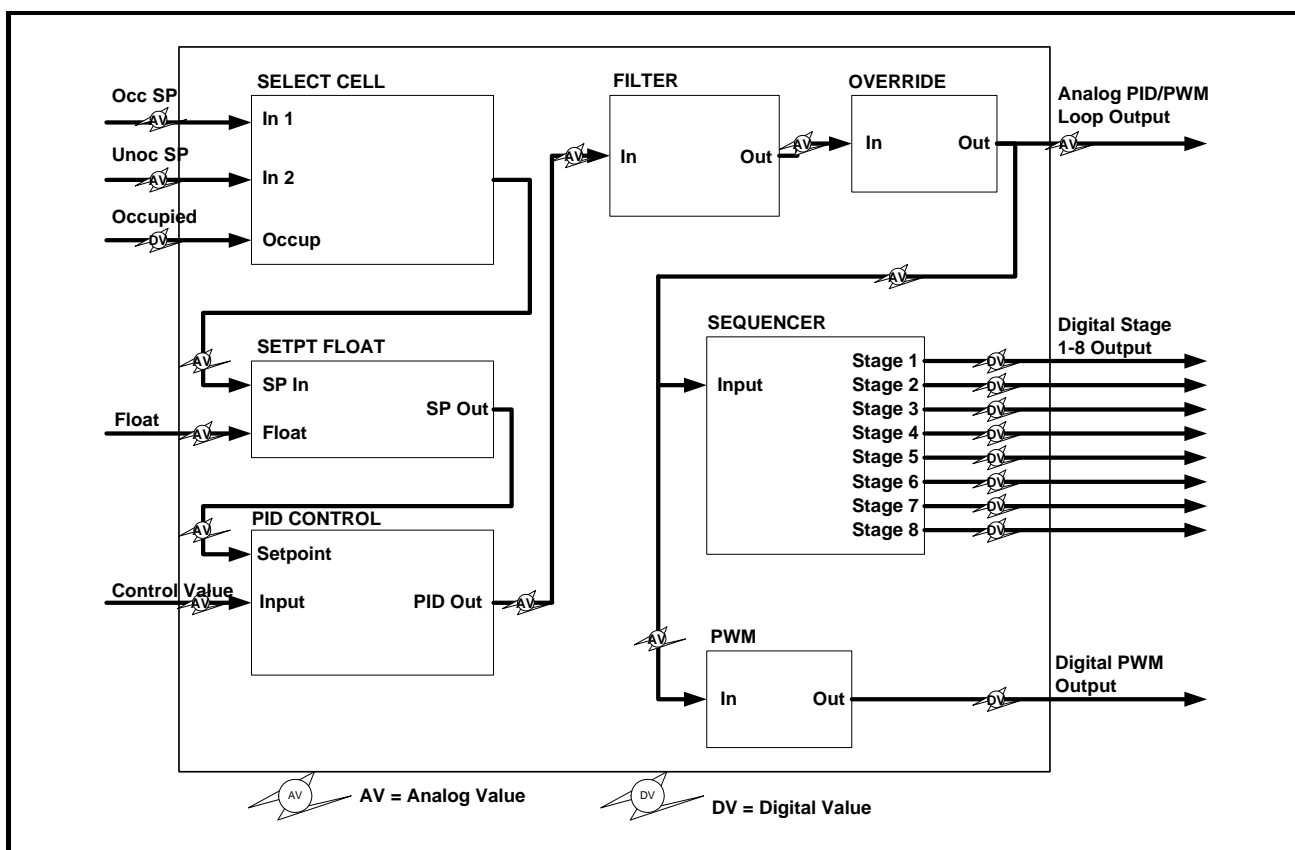

Figure 11-24 - Loop/Sequence Control Application Diagram

11.13.2 Loop/Sequence Control Cell Descriptions

11.13.2.1 The Select Cell

The Select cell's function is to provide the control setpoint to the PID Control cell, and to switch between occupied and unoccupied setpoints based on the current state of occupancy.

To determine whether to use the occupied setpoint or the unoccupied setpoint, the Select cell reads a digital

input. If this input is ON (OCC), the occupied setpoint is used. If this input is OFF (UNO), the unoccupied setpoint is used.

If the occupancy input is NONE, the Select cell will assume this application will not use occupancy-based setpoints, and will use the occupied setpoint only (no switching).

Note the Select cell does not have any on-board schedule function to determine for itself whether the building is occupied or unoccupied. It relies solely on the digital state

of the Occupancy input. If you wish to follow a schedule for occupancy, this input must be tied to the output of a Time Schedule application.

11.13.2.2 The Setpoint Float Cell

The Setpoint Float cell provides users to raise and lower the control setpoint based on the value of a sensor (called the “float” sensor). The float sensor can be any type of analog sensor, but is typically a temperature sensor, since most of the applications for floating setpoints involve HVAC and floating the setpoint based on outdoor air temperature.

To set up the Setpoint Float cell, you must provide three values: a High Float Value, a Low Float Value, and an Output Range.

The Output Range is the maximum amount that the PID Setpoint may vary. An Output Range of 4, for example, means that the control setpoint may only be increased by a maximum of 2 and decreased by a maximum of 2.

The High Float Value and Low Float Value form a range of values that determine what portion of the Output Range is applied to the final control setpoint. For example, suppose a Setpoint Float cell is given a High Float Value of 100, a Low Float Value of 0, and an Output Range of 4. When the float sensor value is at the high float value, the setpoint will be increased by its maximum amount (2). When the float sensor value is at the low float value, the setpoint will be decreased by its minimum amount (2). For all float sensor values in between the High Float and Low Float values, the amount added or subtracted to the control setpoint will vary linearly.

If floating setpoint control is not desired, this cell can be effectively disabled by setting the value of the Float Output Range to 0.

11.13.2.3 The PID Control Cell

The PID Control cell uses a PID algorithm to compare the control input value with the control setpoint value. The result of this comparison is a percentage from 0-100%. The PID Control cell repeats this sequence ever few seconds, and the result is a PID percentage that adjusts over time to provide the optimum amount of output to achieve the setpoint.

The 0-100% output from the PID Control cell is passed along to the Filter cell.

Bypassing PID

For users who simply wish to convert an analog output to a pulse width modulation or sequenced (staged) output, a Loop/Sequence Control application can be programmed to bypass PID Control altogether. If this option is selected, the Loop/Sequence Control application completely ignores the Select, Setpoint Float, and PID Control cells,

and passes on the value of the control input directly to the Filter cell.

Note that when bypassing PID, the control input must be an analog percentage from another E2 application or a 0-10VDC analog signal from an input point.

11.13.2.4 The Filter Cell

The Filter cell’s primary function is to slow the rate of change of the PID cell’s output. The filter reads the difference between the current output value and the value x seconds ago, where x = a user-specified period of time. The difference between these two values is multiplied by the filter ratio, which is a percentage between 0% and 100%. The result of this multiplication is the output value. Note that if the filter ratio is at 100%, or if the Filter cell is disabled, the input is not modified by the Filter cell.

11.13.2.5 The Override Cell

The Override cell’s function is to provide a method of overriding the analog output going to the Sequencer and PWM cells to a user-specified value instead of the value called for by the Filter cell. The Override cell can override the output to any value between 0% and 100%, and may be either fixed or timed. A fixed override remains overridden until the user deactivates the override, while a timed override remains in effect until a user-specified time has elapsed.

11.13.3 Output Cell Descriptions

The Loop/Sequence Control application has three control outputs: a standard 0-100% analog output, a set of up to eight staged outputs, and a pulse width modulation (PWM) output. The analog control output comes directly from the Override cell. However, the same control output is fed into the Sequencer and PWM cells for translation into digital staged outputs and pulse width modulation.

11.13.3.1 The Sequencer Cell

The Sequencer cell simply activates a certain percentage of the Digital State 1-8 outputs based on the percentage of the control output. For example, if the control output is 50%, the Sequencer cell will activate 50% of the total number of stages. The Sequencer cell will always round DOWN; that is, if there are four stages in a Sequencer cell and the output is 74%, the Sequencer cell will only activate two stages (or 50% of the stages). When the output climbs above 75%, the third stage will activate.

If desired, delays may be specified for stage activation and deactivation. Also, the definitions of OFF and ON may be redefined as either ON, OFF, or NONE.

11.13.3.2 The PWM Cell

The PWM cell converts the control output percentage into a periodic ON pulse. A “pulse” in this cell is a con-

stant period of time that consists of one ON event and one OFF event. The PWM cell takes the PID percentage and turns the output ON for an equivalent percentage of the total pulse period. In other words, if the PID output is 60% and the pulse period is 30 seconds, every 30 seconds the PWM output will be ON for 60% of 30 seconds (18 seconds) and OFF for the remaining portion of the 30-second period. Once the period has ended, the PWM Cell reads the PID output again and the process is repeated.

11.14 Time Scheduling and Holidays

Time Schedules are used for timed activation and deactivation of loads and for providing occupied and unoccupied building times for occupancy-driven systems (such as Sensor Control, Lighting, and HVAC).

There are four different types of schedules used by the E2. Brief description of each of these are given below:

Master schedules are the main scheduling unit used by the E2. A master schedule consists of up to 15 scheduled ON/OFF event pairs, which may be programmed to occur on any individual date and time or series of dates and times. Master schedules may also drive slave schedules.

Slave schedules are similar to master schedules, except their operation is driven by a master schedule. Slave schedules, generally, are alterations of the master schedule's event times. The ON/OFF times in a slave schedule may take place either at specific defined times of the day or relative to the times given in the master schedule. For example, a master schedule may say: "The building is occupied from 8:00 a.m. to 9:00 p.m." while one of its slave schedules says "Dim the building lights 15 minutes before the store closes."

Slave schedules may also be mastered by other slave schedules to create a series of stacked schedules.

Holiday schedules are used to tell master and slave schedules that a special day or event is occurring. For example, master schedules and their corresponding slave schedules may be programmed with special holiday events, such as "Keep all lights off during Holiday x." The holiday schedule's job is to inform the schedules to which it is connected, "Today is Holiday x."

Although holiday schedules are used exclusively by Time Scheduling applications, they are set up as individual applications separate from Time Scheduling. See **Section 11.14.2, *Holiday Schedules*** for more information.

Temporary schedules are technically not schedules but temporary override functions that may be made to

exist within an individual master or slave schedule. Temporary schedules are used to temporarily override the ON/OFF instructions of an individual master or slave schedule. Generally, temporary schedules are only used for one-shot applications, such as keeping the lights on an extra hour for a single night. Temporary schedules override all other events within a master or slave schedule, including holidays.

11.14.1 How Schedules Work

11.14.1.1 Events

Master schedules and slave schedules consist of up to 15 pairs of **events**. Events are simple commands to turn the schedule output either ON or OFF at a particular time within a range of days. Events are usually programmed in pairs, so that during a specified range of days the schedule output can be turned ON and OFF at a particular time within the same day. However, events may be programmed singularly (on OFF or one ON command per day). Events may be programmed to take place on any or all days from Sunday to Saturday. In addition, events may take place on any or all of four holiday (or "special") dates, called HD1, HD2, HD3, and HD4. Holiday schedules are used to tell the master or slave schedules when these special dates occur.

11.14.1.2 Absolute and Relative Events

Master schedule events always occur at specific times of the day. In other words, when you program an event pair in a master schedule, you must specify two specific times of the day the events will occur. These types of events are called **absolute events**.

However, when programming event times in slave schedules, you may choose to enter event times that are relative to its master schedule's ON and OFF times. These types of events are called **relative events**. They are programmed not as absolute times but as amounts of time before or after its master schedule's events.

For example, suppose a master schedule is set up to be ON at 8 a.m. and OFF at 9 p.m. every day of the week, and you wish to set up a slave schedule so that its output comes ON 15 minutes before the master comes ON and OFF 15 minutes after the master goes OFF. To do this, you would set up the slave schedule to come ON at -00:15 and OFF at +00:15 every day of the week. The slave schedule will automatically determine the correct ON and OFF times.

11.14.1.3 Temporary Schedule Events

Each schedule may also be given up to three pairs of temporary schedule events. These events start and end at specific days and times and do not continue past those dates (in other words, temporary events cannot be made to

occur weekly or annually).

11.14.1.4 Overlapping

Events may, and often do overlap within a schedule. When events overlap, the E2 uses the following priority structure, from highest to lowest:

1. Temporary Schedule Event #1
2. Temporary Schedule Event #2
3. Temporary Schedule Event #3
4. Events that occur on HD1 (Holiday #1)
5. Events that occur on HD2 (Holiday #2)
6. Events that occur on HD3 (Holiday #3)
7. Events that occur on HD4 (Holiday #4)
8. Temporary Schedule Events of a slave schedule's master schedule (if applicable).
9. Standard events within the schedule itself.

11.14.1.5 Ranges

In addition to the 15 events within a master or slave schedule, up to 12 standard ranges may be specified. Ranges are sets of dates that specify which days within the year the schedule's events will be applied. The E2 checks the list of ranges to see if the current date falls within any of the twelve possibilities; if the date does not fall within a range, none of the schedule's events will occur.

When no date ranges are specified, the schedule is considered to be active. All scheduled events will occur normally.

11.14.2 Holiday Schedules

A Holiday Schedule application's primary function is to pass along the day of the week to one or more master or slave schedules, and to tell these schedules when it is a holiday (HD1 - HD4). A holiday schedule determines holidays by cross-referencing the current date with its user-programmed list of holiday date ranges. During the time periods of these date ranges, the holiday schedule tells the schedules to perform the events programmed for one of the four holiday dates (HD1, HD2, HD3, or HD4).

Because multiple E2s on a network would likely use the same holiday schedules for determining special occupied and unoccupied building hours, holiday scheduling is handled by Global Data. This means the holiday schedule can be set up in one E2 and shared with all other E2s that use time scheduling.

11.15 Power Monitoring

A Power Monitoring application is used primarily for monitoring, recording, and to a lesser degree controlling

KW usage in a building.

11.15.1 Overview

Explanation of "Demand"

Power companies supply power to consumers at a fixed rate per kilowatt hour until a pre-defined level of energy consumption is reached. This level is called the **demand limit**. When the demand limit is exceeded, the rate is greatly increased as a penalty for high power demand by the consumer. Generally, once the demand limit is exceeded, the increased rate is charged for the remainder of the year.

To determine if you have reached the demand limit, the power company arbitrarily monitors a consumer's energy consumption for a fixed period of time. This monitoring period is called a **demand window**. Power companies can generally tell you how long a demand window period lasts, but you'll never know when the measurement will take place.

How Power Monitoring Calculates Demand

To help you make sure you do not use more power than the demand limit, the E2's Power Monitoring applications determine your current KW usage in much the same way as your power company. Power Monitoring uses a watt-hour transducer input to determine the current KW usage. Multiple KW values are averaged together into "demand windows," much like the ones power companies use.

Then, depending on how the application is configured, the most current KW value is compared to a demand setpoint. The "current KW value" in this case may be either the instantaneous value read by the power transducer, or it may be the average of all KW transducer readings taken over 1-minute intervals. This setpoint should be equal to or slightly lower than the demand limit set by your power company.

In short, since E2 doesn't know when the power company's demand window will begin, the E2 measures power as if the demand window could happen at any time. This way, E2 can more accurately determine when your site is approaching or exceeding the demand limit.

Shed Mode

If the KW usage is higher than the demand setpoint, Power Monitoring goes into Shed Mode. During Shed Mode, Power Monitoring turns on a digital output called SHED OUT. This output may be connected to the demand shed inputs of one or more E2 applications, which will in turn shut down or otherwise curb the power usage of the overall system. The SHED OUT output remains ON until the KW usage falls below the demand setpoint.

In short, the purpose of Shed Mode is to get the total KW usage below the demand setpoint as soon as possible.



NOTE: *If you do not wish to use load shedding for your building, simply do not connect anything to the SHED OUT output.*

11.15.2 Logging

Power Monitoring applications are pre-programmed with extensive logging capabilities that record the hourly, daily, and monthly power usage statistics.

Hourly

The hourly log contains a list of power usage summaries of the previous 48 hours. An hourly log entry contains:

- The time and date of the entry
- The KWh for that hour
- The maximum average KW that occurred within any demand window for that hour
- The highest instantaneous KW reading taken for that hour, and the time that reading was taken

Daily

The daily log contains a list of power usage summaries for the previous 48 days. A daily log entry contains:

- The date of the entry
- The KWh for that day
- The maximum average KW within any demand window for that day
- The highest instantaneous KW reading taken for that day, and the time that reading was taken
- The total number of minutes the Power Monitoring application was in Shed Mode
- The Heat Degree Days for that day
- The Cool Degree Days for that day

Monthly

For monthly logging, the day of month can be user-specified so the day of the month on which the utility billing period starts can be accurately compared to the utility bill. The monthly log contains a list of power usage summaries for the previous 24 months. A monthly log entry contains:

- The month and year of the entry
- The KWh for that month
- The maximum average KW within any demand window for that month

- The highest instantaneous KW reading taken for that month, and the date and time the reading was taken
- The total number of minutes the Power Monitoring application was in Shed Mode
- The Heat Degree Days for that month
- The Cool Degree Days for that month

Definition of Heat and Cool Degree Days

Heat degree-days and cool degree-days are standard industry measurements of the demand for heating and cooling. This measurement is based on the daily average outdoor air temperature.

If the daily average temperature is **below 65°F**, then the number of heat degree-days for that day is equal to 65 minus the day's average temperature in degrees Fahrenheit. Example: if the day's average temperature is 54°F, the number of heat degree-days for that day is 65-54 = 9 heat degree-days.

If the daily average temperature is **above 65°F**, then the number of cool degree-days for that day is equal to the day's average temperature in degrees Fahrenheit minus 65. Example: if the day's average temperature is 71°F, the number of cool degree-days for that day is 71-65= 6 cool degree-days.

Larger degree-day numbers indicate a larger demand for heating or cooling. Degree-day totals may be added together to indicate heating and cooling demand for weeks, months, or years. E2 does this to keep monthly logs of heat and cool degree-days.

11.15.2.1 Power Monitoring Input

The Input Type Selection parameter defines the way the Power Monitoring input (**INPUT** under the Inputs tab in application Setup) will be used. The parameter can be set to: **KW Analog**, **Pulse KWH**, **Current (Amps)**, or **Current 3-phase**.

Settings

When **KW Analog** is selected, verify the input is connected to a board and point that is set up with Engineering Units of KW. When **Pulse KWH** has been selected, verify the input is connected to a board and point that is set up with Engineering Units of KW. When **Current (Amps)** has been selected, verify the input is connected to a board and point that is set up with Engineering Units of Amps. When **Current (3-phase)** has been selected, verify the input is connected to a board and point that is set up with Engineering Units of Amps. Note that for 3-phase, three power monitoring inputs will appear under the Inputs tab of the application. All inputs must be connected to board and points set up with Engineering Units of Amps.

11.16 Anti-Sweat Setup

An anti-sweat application controls one anti-sweat zone. An anti-sweat zone is defined as one or more anti-sweat heaters that use the same dewpoint (or RH and temperature) sensors and the same control setpoints. If all the outputs on a 20-channel PMAC panel are going to use the same setpoints and dewpoint device(s), then all the heaters may be set up in a single zone.

Zones are set up in a single screen called the Anti-Sweat Control Setup screen.

11.16.1 How Anti-Sweat Works

Anti-sweat applications control anti-sweat heaters by monitoring the dewpoint. A dewpoint value may come from a dewpoint probe mounted within the Zone, or it may be calculated automatically by the E2 using a combination of a relative humidity sensor and a temperature sensor.

The dewpoint value is used to pulse the heaters ON for a certain percentage of a user-defined time interval. The dewpoint is compared to the anti-sweat application's control setpoints (the Full ON Dewpoint and the Full OFF Dewpoint). Based on this comparison, the anti-sweat heaters will do one of three things:

- If the dewpoint is equal to or above the Full ON Dewpoint, the heaters remain ON 100% of the time.
- If the dewpoint is equal to or below the Full OFF Dewpoint, the heaters will be ON 0% of the time (fully OFF).
- If the dewpoint is between the Full ON and Full OFF Dewpoint, the heaters will be pulsed ON for a percentage of the specified time interval. The percentage is determined by proportionately measuring where the dewpoint falls between the range of values formed by the two setpoints.

Figure 11-6 shows an example of an anti-sweat application. The setpoints (Full ON = 80°F, Full OFF = 20°F) form the range of dewpoints across which the heaters will be pulsed. When the measured dewpoint is 45°F (directly in between both setpoints), the percentage will be 50%, and the heaters will be pulsed ON for five seconds of the defined 10-second interval. If the dewpoint drops to 30°F, the percentage will lower to 20%, and the heaters will be on only two seconds out of every 10.

11.17 Heat/Cool Control

Heat/Cool Control is a special kind of sensor control that applies to heating and cooling devices. Heat/Cool Control applications use PID control to vary the amount of heating and cooling based on the current temperature and

its relation to the heating or cooling setpoint. Both staged and modulated (0-100%) heating and cooling outputs are supported by Heat/Cool Control.

Heat/Cool controls are available in RX units, allowing small installations with simple HVAC systems to use one controller for all refrigeration and HVAC systems.

11.17.1 Temperature Control

Heat/Cool applications use PID control to vary the output of heating and cooling devices. As is the case with all applications that use PID control, Heat/Cool control makes use of a PID setpoint and a throttling range. Refer to **Appendix D: PID Control** for more information.

Unlike normal PID loops that assume a 50% output is required to keep the temperature stabilized on the setpoint, Heat/Cools strive to stabilize the temperature on the setpoint with the output at 0%. Thus, when the temperature goes below a heating setpoint or above a cooling setpoint, the heating or cooling outputs climb from 0% to 100% as determined by the throttling range (see **Figure 11-25**).

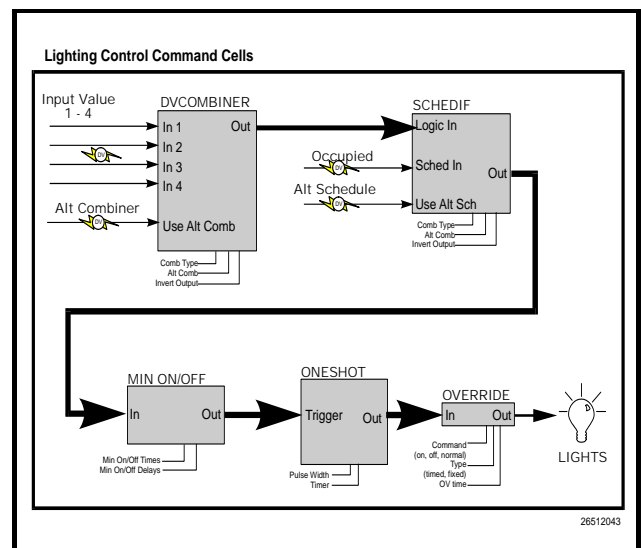

Figure 11-25 - Example of Heat/Cool PID Control

By default, only the proportional and integral modes of PID control are enabled for Heat/Cools. The user may choose to add the Derivative mode or to get rid of the Integral mode and use strictly Proportional control.

11.17.2 Unoccupied Hysteresis

When the Heat/Cool receives an indication that the building is unoccupied, the control mode changes from the PID method described previously, and uses simple ON/OFF control of the heating and cooling outputs.

The Heat/Cool application in unoccupied mode makes use of a hysteresis value to form a range of temperature values across which the heating and/or cooling will be applied. As shown in **Figure 11-26**, when the temperature

drops to the Unoccupied Heating Setpoint or rises to the Unoccupied Cooling Setpoint, the heat or cool outputs go to 100% ON. They remain in this state until the temperature rises above the heating setpoint plus the hysteresis, or below the cooling setpoint minus the hysteresis, at which time the outputs will go to 0% ON.

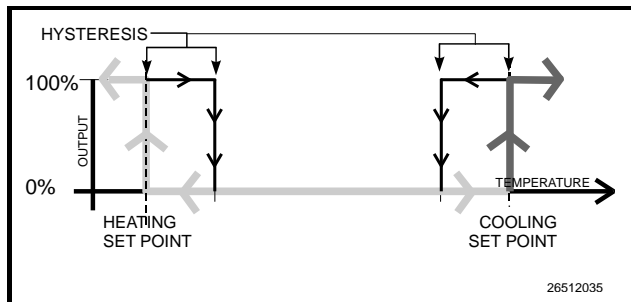

Figure 11-26 - Unoccupied Hysteresis Mode

11.17.3 Optimum Start/Stop (OSS)



NOTE: OSS applies only to Heat/Cools that use a time schedule to change occupancy states. Overrides initiated by the digital OCC STATE input will not initiate pre-starts or pre-stops.

Optimum Start/Stop (OSS) is a feature that works alongside the Heat/Cool's occupied and unoccupied temperature control modes. OSS takes control of heating and cooling several minutes before the building is scheduled to change occupancy states, and prepares the building for the upcoming change in setpoints. As a result, when the occupancy state changes, the temperature will be comfortably within the range of the new setpoint.

Figure 11-15 shows an example of how pre-starts and pre-stops work in a heating application. From unoccupied mode, the pre-start period ramps the temperature up slowly so that when the scheduled change from unoccupied to occupied mode occurs, the temperature will already be at or near the occupied heating setpoint. During the pre-stop, which occurs before the Heat/Cool goes from occupied to unoccupied mode, heating is suspended and the temperature is allowed to "coast" down to the unoccu-

pled setpoint.

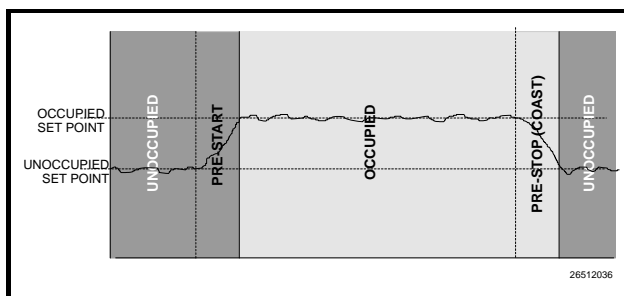

Figure 11-27 - Diagram of Pre-Start and Pre-Stop Operation

Intelligent Pre-Starts and Pre-Stops

OSS is designed to handle pre-starts and pre-stops in the most energy-efficient manner possible. Every time a pre-start or pre-stop occurs, OSS measures the amount of time it takes to bring the temperature from the previous setpoint to within the "comfort zone" of the new setpoint (a user-defined range of values above and below the setpoint within which the temperature is considered acceptable). This duration is used to determine the average rate of temperature change, called the K factor.

The K factor is stored in the memory along with the average value of the outdoor air temperature during the pre-start or pre-stop. Over time, collected K factor data will be sorted and combined into a table. As a result, by constantly observing and recording the results of previous pre-starts and pre-stops, OSS will be able to intelligently guess how much time a pre-start or pre-stop mode should last based on the outside temperature.

Heat/Cools keep track of three different kinds of K factors:

- *Heat K factor* - used to guess pre-start durations for Heat/Cools operating in heating mode.
- *Cool K factor* - used to guess pre-start durations for Heat/Cools operating in cooling mode.
- *Coast K factor* - a measurement of the change in temperature when no heating or cooling is active. This is used to determine pre-stop durations for both heating and cooling Heat/Cools.

11.17.4 Setpoint Reset

If desired, Heat/Cools may be configured with a Setpoint Reset that varies the value of the heating and/or cooling setpoints based on an analog value from a reset sensor. This is most often used to vary the value of a heating or cooling setpoint based on the outside air temperature.

To set up a setpoint reset for heating or cooling, the user must specify the minimum and maximum range of reset sensor values, and the maximum range of setpoint

adjustment.

As the value of the reset sensor varies within the minimum and maximum range, an equivalent portion of the maximum setpoint adjustment will be added or subtracted from the heating or cooling setpoint. When the reset sensor value is directly in between the minimum and maximum range values, nothing will be added or subtracted from the setpoint. Between the halfway point and the minimum value, part of the setpoint adjustment will be subtracted from the setpoint. Between the halfway point and the maximum value, part of the setpoint adjustment will be added to the setpoint. An example of this is shown in *Figure 11-28*.

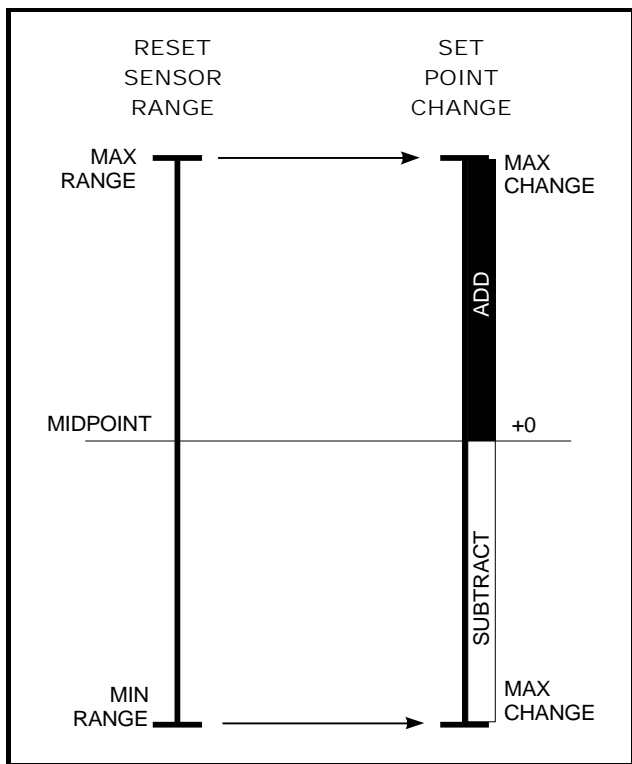

Figure 11-28 - Setpoint Reset Diagram

11.17.5 Lead/Lag

A Heat/Cool application may be linked with another Heat/Cool application in what is called a “Lead/Lag” arrangement. In this arrangement, one Heat/Cool is designated as the Lead loop and used as the primary space temperature control device. The other Heat/Cool, the Lag loop, becomes active only to support the Lead loop when it is unable to keep the space temperature within a certain proximity of the setpoint (called the setpoint delta).

Figure 11-29 shows how a pair of Heat/Cool applications using a Lead/Lag arrangement would operate in Cooling mode. When the temperature is in between the

setpoint and the setpoint delta, the Lead loop alone will control cooling. However, when the temperature is above the setpoint delta, the Lag loop will come on-line, and both Lead and Lag loops will work to bring the temperature down.

The Lead/Lag arrangement works similarly in Heating mode, except that the setpoint delta is below the Heating setpoint, and Lead and Lag are both on when the temperature is below the setpoint delta.

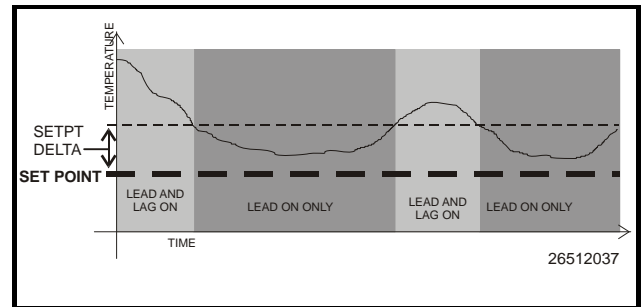

Figure 11-29 - Lead/Lag Arrangement

Heat/Cools in a Lead/Lag arrangement take turns acting as the Lead loop. The user designates the maximum amount of time a Heat/Cool will act as a Lead loop; after this duration, the current Lead loop will switch places with its Lag loop.

Lead/Lag arrangements only work when both Heat/Cools are in Occupied mode.

Dehumidification control uses the AHU’s existing cool stages (and a separate dehumidification device such as a desiccant wheel, if available) to remove moisture from the air.

The dehumidification setpoint is placed at the 0% end of the dehumidification PID throttling range. In other words, the dehumidification output will start at 0% when the humidity is equal to the setpoint and increase to 100% when the humidity is equal to or above the setpoint plus the throttling range.

The dehumidification output percentage is used much like a heating or cooling output percentage is used in Temperature Control. The percentage represents the percentage of total dehumidification capacity available to the AHU (including cool stages and other dehumidification devices).

11.18 Analog and Digital Combiners

Instead of using a single output source as an application input, you may use a combination of up to sixteen input sources. To use multiple inputs, a Multiple Input cell

must be used.

A Multiple Input cell is a simple application that reads data values from its inputs, combines them using a user-defined combination strategy, and sends the combined value to the desired application input.

A common application for this is in HVAC control, where a single heating control value might come from an average of a number of temperature sensors throughout the building.

Two different types of Multiple Input cells may be used, depending upon whether the inputs to be combined are analog or digital sources.

11.19 TD Control

11.19.1 Overview

The TD Control application controls fans sequentially based on the temperature differential (TD) of the condenser. When an increase is called for, the next fan will turn on when the time since the last fan state change is greater than the Fan On Delay Time setpoint (or will turn on immediately if the last change was more than the Fan On Delay). Additional fans will be staged on at Fan On Delay intervals while an increase in capacity is called for. When a decrease is called for, the next fan will stage off when the time since the last fan state change is greater than the Fan Off Delay Time setpoint (or will turn off immediately if the last change was more than Fan Off Delay). Additional fans will be staged off at Fan Off Delay intervals while a decrease in capacity is called for.

11.19.2 Temperature Differential (TD) Strategy

TD strategy attempts to maintain a constant difference (i.e., TD setpoint) between the temperature of the refrigerant and the ambient temperature. The TD setpoint allows you to set the constant that is to be maintained.

TD strategy uses drop leg temperature for the refrigerant temperature and plenum temperature for the ambient temperature. The formula for determining the TD control value is:

$$TD = (\text{dropleg temp}) + (\text{dropleg offset}^*) - \text{plenum temp.}$$

* *DropLeg Offset is a user-configured parameter to allow fine-tuning of the drop leg temperature measurement.*

In TD condenser control operation, when the TD rises above $TD \text{ setpoint} + (TD \text{ deadband} / 2)$, an increase in fan capacity is called for. Similarly, when the TD drops below $TD \text{ setpoint} - (TD \text{ deadband} / 2)$, a decrease in fan capacity is called for. TD can control up to four condenser fans.

11.19.3 TD Control Fail-Safes

TD Control operates as long as plenum and drop leg temperature inputs are available and the drop leg temperature remains within a minimum/maximum range configured by the user. Otherwise, TD control uses various fail-safe modes to control the condenser fans.

In the event drop leg temperature is not available (due to probe failure), all fans will be staged on.

Drop Leg Temperature Above Maximum Drop Leg Setpoint

If the Drop Leg temperature (Drop Leg Temp) rises above the maximum drop leg temperature setpoint (Drop Leg Max), an increase will be called for until Drop Leg Temp drops below Drop Leg Max. This protects against the possibility of the Drop Leg Temp rising too high as a result of high plenum temperature.

Drop Leg Temperature Below Minimum Drop Leg Setpoint

If the Drop Leg temperature drops below the minimum drop leg temperature setpoint (Drop Leg Min) a decrease will be called for until Drop Leg Temp rises above Drop Leg Min. This protects against the possibility of the Drop Leg Temp falling too low as a result of low plenum temperature.

Plenum Temperature Not Available

If plenum temperature is not available (due to probe or communication failure), control will be based on the Drop Leg Min and Max setpoints.

11.19.4 Configuration

TD Control allows the user to operate a condenser at its designed temperature differential and saves energy by maintaining optimal condenser TD with the least amount of fans on as possible.

Standard discharge pressure control may attempt to operate the condenser below its designed TD and turn on more fans than necessary.

Set the number of condenser fans to be controlled in the **Num Cond Fans** field under Setup (**4** is the default value).

11.19.5 Setpoints

TD setpoints are configured to allow control of the condenser at its designed TD during swings in ambient temperature.

For the Drop Leg Minimum setpoint, if the drop leg temperature falls below this setpoint, condenser fans will be cycled OFF regardless of the value of the TD setpoint.

For the Drop Leg Maximum setpoint, it is the maximum allowable value of the drop leg temperature. If the

drop leg temperature rises above this setpoint, the condenser fans are cycled ON regardless of the value of the TD.

The Drop Leg Offset setpoint is an adjustment entered, if needed, after measuring liquid subcooling during operation of an individual condensing unit.

The TD setpoint is the optimal difference between the refrigerant drop leg temperature and the ambient (plenum) temperature. When the TD (i.e., *drop leg temp + drop leg offset - plenum temp*) begins to climb above this setpoint, fans will be cycled ON to bring down the drop leg temperature, thus lowering the TD measurement.

The TD deadband setpoint is a range of values around the TD Setpoint within which the value of the TD calculation is acceptable. When the TD rises above the setpoint plus 1/2 the deadband value, fans will begin cycling ON. When the TD falls below the setpoint minus 1/2 the deadband value, fans will cycle OFF.

For the Condenser Fan On Delay setpoint, fans are cycled ON when the TD is above the setpoint at the rate set for Condenser Fan On Delay. For example, if this field is set to **30** seconds, each fan is staged ON in 30-second intervals until all fans are ON, or until the TD falls back below the setpoint.

For the Condenser Fan Off Delay setpoint, fans are cycled OFF when the TD is below the setpoint at the rate set for Condenser Fan Off Delay. In other words, if this field is set to **30** seconds, each fan is staged OFF in 30-second intervals until all fans are OFF, or until the TD rises back above the setpoint.

11.19.6 Inputs

The Drop Leg Temperature input is the current drop leg temperature used for TD control.

The Plenum Temperature input provides the current value of the ambient temperature used for TD calculation.

11.19.7 Alarms

For Drop Leg High alarm, the alarm setpoint is the drop leg temperature that, if exceeded, will cause an alarm to be generated. If you wish to generate an alarm for high drop leg temperature, enter the desired setpoint. Otherwise, to disable this alarm, leave the value set to **NONE**.

For Drop Leg Delay, if the drop leg alarming feature is used, enter the amount of time the drop leg temperature must be higher than the setpoint before an alarm will be generated (HHH:MM).

For TD High alarm, the TD alarm setpoint is the value of the TD calculation that, if exceeded, will cause an alarm to be generated. If you wish to generate an alarm for high TD, enter the desired setpoint. Otherwise, to disable this alarm, leave the value set to **NONE**.

For TD Delay, if the TD alarming feature is used, enter the amount of time the TD must be higher than the setpoint before an alarm will be generated (HHH:MM)

11.20 Pulse Accumulation

11.20.1 Overview

The Pulse Accumulation application counts incoming pulses and converts that consumption value into a rate value once per minute. Pulses are user-specified by the Input Type parameter (power, gas, liquid, or volume) to represent what is being measured.

The Pulse Accumulator input can support many types of pulse counting applications, such as flow meters for water and gas applications. In addition, application-specific logging, such as hourly, daily and monthly usages are supported for pulse type inputs.

11.20.2 Configuration

Set the Input Type parameter to the desired measurement (power, gas, liquid, or volume).



NOTE: *The engineering unit for the Pulse Accumulator Type Input is specified by the active EU parameter. This parameter is located in the General Controller Information screen under the Engineering Units tab and determines what unit of measure will be used when the Input Type is set.*

The analog input connected to the board and point number must be configured as a Pulse Accumulator Type input. The engineering unit of the analog input must match the engineering unit that is being used in the Pulse Accumulation application.



TIP: *The engineering unit that is active in the Pulse Accumulation application can be determined by viewing the Total Accumulation output on the application Status screen.*

11.20.3 Outputs

All output information is available from the main Status screen or from under the Outputs tab in application Setup. Current output status, average output, high trip,

total accumulation, and the last accumulated total information can be viewed.

The current output shows the rate of consumption of the quantity represented by pulses. Average output shows the average rate value accumulated over the period set in the Average Window parameter. The High Limit Trip output will turn on if the total accumulation exceeds a user-specified high limit. Total accumulation shows the total accumulated value since the last reset. Last Total output shows the total accumulated value when the last reset occurred.

11.20.4 Accumulator Reset Types

The Pulse Accumulator is a register that is increased by the value of each update of the Quantity Accumulation input. Each time the Accumulator is reset, before clearing, its value is saved to a Last Total output. The type of reset the Accumulator uses can be user-specified with the Accumulator Reset Type parameter. The Accumulator can be set to reset at a certain time of day, day of the month, when a high-limit trip occurs, or not to reset at all.

11.20.5 Logging

Rate and usage data is logged and stored using application logging. Data is stored in hourly, daily, and monthly formats. All logged data can be erased from memory by using the Applications Command menu. In addition, application logs show the total and peak rates of consumption for the last day, hour, and month.

The Hourly log will be updated every hour at the top of the hour and contain data for the last 48 hours. Time, date, total accumulation for that hour, maximum average for that hour, maximum peak value, and time of peak value, are stored in this log.

The Daily log will contain data for the last 48 days. Date, total accumulation for that day, maximum average for that day, maximum peak value, time of peak value, and minutes tripped are stored in this log.

The Monthly log will contain data for the last 24 months. The log will be updated on a user-specified day of the month. Date, total accumulation for that month, maximum average for that month, maximum peak value, time of peak value, and date of peak value are stored in this log.

Application graphing generates hourly, daily, and monthly graphs from the application log data. All graphs show the total and max average.

On the main Status screen, consumption for the current hour, day, and month are displayed.

11.20.6 High Trip

A high-trip output can be triggered if the Accumulator's total quantity exceeds a user-defined setpoint. The

trip point output can be controlled by any of three input sources. The output will be turned ON when the input source is equal to or greater than a user-specified value. The total amount of time the application has been in a high trip condition is shown in the Time In Trip Today output.

11.21 Irrigation Control

11.21.1 Overview

Irrigation control is an application used for the controlling of sprinkler systems. This application controls watering by duration of time or water usage parameters. Days of the week and times for watering are set by the user with a maximum of two Irrigation applications allowed in the CX controller.

The master water valve is turned ON and OFF as water is needed for a zone. When disabled, no application control of any outputs will be possible and the System Status output will indicate **Disabled**.

Under normal control only one zone will be active at a time.

11.21.2 Zones and Cycles

A zone is defined as a single line of irrigation fed from a main water supply valve (i.e., a group of sprinklers that are attached to the same line of irrigation). Up to 16 zones of irrigation per application are supported with six start times for watering. The user will be able to configure each zone to function on different days of the week or odd or even days of the month.

Zones are turned ON one at a time starting from the first enabled zone. The zone that is ON is considered to be the active zone. Its state is set to ON and its valve output is also set to ON. When the active zone completes its time duration, its state will be set to Done and its valve output set to OFF.

For enabled zones that are not active or complete, the states will be set to Pending and the valve output set to OFF.

A cycle is the sequence of all defined zones irrigating one at a time. A cycle is considered complete when the last defined zone finishes irrigating and shuts OFF. Each zone turns ON one at a time, starting with the first defined zone until the last defined zone in the list turns OFF.

The **Number of Zones** parameter (with a default value of 4) specifies how many zones the application will use. No two zones are ever ON at the same time; each zone starts and stops independently and waits for the other to finish before another zone starts.

11.21.2.1 Cycle Control Types

By default, Timed cycles are always used unless the user has configured a flow sensor (optional). If a flow sensor is configured, a control type parameter will become visible where the user can select *either* a Timed or Volume cycle control type.

During any cycle, the disabled zone states and valve outputs will be set to OFF.

For midnight crossover times, a cycle will be completed if the duration extends into the next day.

11.21.2.2 Timed

Instead of start and stop times entered to define the length of time a zone is on, the user enters a *duration* of time. The default parameter called **On Time** (with a default value of 2 hours entered in HHH:MM format) is used when a certain length of time is desired for watering. Irrigation begins per cycle start time and lasts for all zone durations that are active for the current day. For example, if a time of 30 minutes (0:30) is entered, that zone will stay ON for 30 minutes and then shut OFF.

11.21.2.3 Volume

Under volume control, enabled zones will be cycled until the set volume of water for each zone has been dispensed for the current cycle or an amount of time has elapsed equal to the duration parameter. (This is a feature to prevent water runoff.) When irrigation is stopped for a zone due to elapsed time, control will cycle to the next active zone.

11.21.3 Cycle Scheduling

Irrigation cycles can only be started during a user-defined irrigation “season.” The **Season Source** parameter allows the user to select how to determine the season by either using the Dates parameters or the Summer/Winter input.

If the user selects **Dates**, start and stop day and month parameters will become visible and are used to specify the season. Each zone will have parameters to configure what days of the month it should participate in irrigation cycles. If the user selects **Summer/Winter**, an input of the same name will become visible under the **Inputs** tab. The season will be active when this input indicates **Summer**.

The Summer/Winter input is automatically connected to the Global Data output of the same name.

If the season is not active, the System status will be set to **Off Season** and no normal or manual cycles will be possible. This prevents accidental cycles from occurring after the system has been “winterized.”

11.21.4 Zone Inhibit

Inhibiting sensors enable a zone to terminate irrigation early when enough water has been dispensed for the current cycle, or completely removes a zone from the cycle. Each zone is equipped with a digital inhibit input called Zone Inhibit.

If the inhibit input is ON, the zone status will be set to **Inhibit** and the valve output will be set to **OFF**.

11.21.4.1 Timed

If the zone is inhibited for Timed control types, it will be excluded from the cycle. If Zone Inhibit turns ON during the cycle, control will transfer to the next defined zone.

11.21.4.2 Volume

For Volume control types, the inhibited zone will be excluded from the cycle only while the inhibit input is ON. If the inhibit input turns off and the cycle is still in progress, the zone’s state will again be set to **Pending** and will again be included in the cycle.

11.21.4.3 Rain Delay

The rain inhibit input should be connected to a rain sensor and will only function during the ON season. In the event of rain, a programmable rain delay of 0-7 days will prevent irrigation cycles for the user-defined number of days from when the rain sensor has detected rain. Active cycles will not be terminated if the input turns ON; however, Rain Inhibit will begin when the active cycle ends.

An entry of 0 days will disable this parameter.

11.21.4.4 Freeze Lockout

An irrigation cycle should be terminated if the current environmental conditions will result in freezing of dispensed water. This is to prevent the sheeting of ice on any adjacent paved surfaces or sidewalks, which could create hazardous conditions for motorists and/or pedestrians.

Zones are inhibited from watering if the outside air temperature falls below the entered setpoint for Freeze Lockout.

11.21.4.5 Alarm

If the zone is inhibited for more than the number of days specified in the Inhibit Alarm setpoint, an Inhibit alarm will be generated for the zone. This alarm will return to normal when the zone is no longer inhibited.

11.21.5 Zone Bypass Inputs

Each zone has a digital bypass input called Zone Bypass Inputs. A zone can be bypassed to ON at any time while the application is enabled. A zone cannot be bypassed to OFF.

When a zone is bypassed to ON, the main water valve will be turned ON immediately.

11.21.5.1 Bypass Failsafe

While each zone is bypassed to ON, a timer is checked. If time has elapsed equal to or greater than the zone's cycle duration parameter, the bypass input will be ignored and the zone will return to normal operation.

For a zone in Bypass Failsafe, its bypass input must be set to **OFF** or **NONE** to reset the Bypass Failsafe and to use the bypass input again.

11.21.6 Flow Sensor-Related Tests

11.21.6.1 Leak Test

For both Timed and Volume control types, if a flow sensor is configured, water flow will be checked via a leak test that is performed at the beginning of the cycle. During the leak test the main water valve will be turned ON and all zone valves will be set to OFF. After an amount of time has elapsed equal to the Flow Alarm Delay, the Water Flow input will be compared to the Minimum Flow for Alarm setpoint. If the water flow is greater than the setpoint, the flow alarm output will be set to ON and a Leak alarm will be generated. If a Leak alarm occurs the cycle will terminate. While a Leak alarm is active, no normal cycles will run and the system status will be set to **Leak Detected**.

A Leak alarm must be cleared by the user or the alarm will return to normal after passing a leak test run by a manual cycle. If an enabled zone is overridden to ON during a leak test, it will cause the test to fail, resulting in a false alarm.

11.21.6.2 Obstructed Zone Test

When a zone becomes active during a cycle, a timer is reset. After time has elapsed equal to the flow alarm delay, the water flow input will be compared to the Min Flow alarm setpoint. If the water flow is less than the setpoint, the flow alarm setpoint output will be set to ON, an Obstructed alarm generated, and the zone will be removed from the current cycle.

11.21.7 Service Modes

The Service Check cycle allows a service technician to visually look for malfunctioning valves and leaks by cycling each zone ON one at a time, starting with the first zone. The active zone uses the **Service On Time** parameter and remains ON for the programmable time period entered for **Service On Time**.

While in the Service Check cycle, any active irrigation cycles will be terminated. The Service Check cycle will continue looping until stopped by the user or the programmable value in the **Suspdn Failsafe** field is reached.

11.21.8 Heat Cut In/Cut Out Setpoints For Each Stage

If the current space temperature is greater than or equal to the heat stage Cut Out setpoint, or the individual cooling stage is currently ON due to a call for cooling (Cut In setpoint or dehumidification), and the current space temperature is greater than the individual COOL stage Cut In setpoint, then begin turning the stage OFF by starting the heat stage Off Delay countdown timer.

Or if the current space temperature is less than or equal to the heat stage Cut In setpoint, begin turning the stage ON by starting the heat stage On Delay countdown timer.

11.21.9 Cool Cut In/Cut Out Setpoints For Each Stage

If the current space temperature is less than or equal to the cool stage Cut Out setpoint, begin turning the cool stage OFF by starting the cool stage Off Delay countdown timer. If the current space temperature is greater than or equal to the Cut In setpoint, begin turning the cool stage ON by starting the cool stage On Delay countdown timer.

11.21.10 Dehumidification Control

Dehumidification control is implemented on an AHU basis, not individual cooling or heating stages. Because of implementation on an AHU basis, dehumidification control is "woven" throughout the cool Cut In/Cut Out as well as the heating Cut In/Cut Out control algorithms by calling for increases or decreases in heating and cooling capacities. The dehumidification algorithm does not directly change the states of the heating or cooling, instead it "influences" the staging process by calling for more, less, or the same amount of cooling, and limit the amount of heat used if a call for heating is necessary during dehumidification.

If the current space temperature is less than the dehumidification minimum space temperature, call for the *end* of dehumidification.

If the current control value used for dehumidification is greater than the dehumidification setpoint plus the deadband divided by two (2), call for an *increase* in dehumidification capacity.

If the current control value used for dehumidification is less than the dehumidification setpoint minus the dehumidification deadband divided by two (2), call for a *decrease* in dehumidification capacity.

11.21.11 Two Speed Fan Control

To determine proper fan speed, determine which heating and cooling stages are ON and if the user has set any of the fan speeds for those stages to High. If any of the

stages have been set to High, then the fan speed should be set to High; otherwise, the fan speed should be set to Low.

If for any reason the algorithm thinks that the high speed and the low speed should both be ON, the high-speed fan should be turned ON only.

Proper fan speed should be set when there are no heating or cooling stages ON, and the Fan Always On Setpoint is enabled.

11.21.12 Configuration

Set the Strategy type under application Setup under the **General** tab to **Separate Setpoints**. Enter the desired values for heating and cooling stages. Cooling, heating, alarm, and miscellaneous setpoints can be edited under additional tabs. Press Control + zero (0) while the **More** tab is highlighted to bring up the list of additional tabs.

11.22 Flexible Combiner

The Flexible Combiner application, a new feature of E2 versions 2.20 and above, is a highly advanced and versatile I/O control program used to combine multiple analog and digital input values using programmed equations similar to those used in spreadsheets.

A Flexible Combiner application may have up to eight analog outputs and four digital outputs, each of whose values are determined by user-programmed equations that mathematically combine up to eight analog inputs and eight digital inputs. Four of the analog outputs have the ability to remember their output state over an E2 power cycle. Additionally, up to four alarms can be set up whose trigger and alarm delays are equations. Alarm type, priority, and the message for each alarm are user-configurable.

Equations used to calculate output values and time delays may use mathematical combinations of any of the Flexible Combiner's analog and digital inputs, as well as numeric and named constants, operators, functions, and even rudimentary if-then logic functions. For control of digital outputs, the Flexible Combiner also supports separate equations that determine ON and OFF delays.

For E2 versions 2.40 and above, the user can set up to four alarms whose trigger and alarm delays are equations. The user may also choose the alarm type, priority, and the message for each alarm.

The Flexible Combiner may also be programmed to operate a digital output as a PWM (pulse width modulation) output. In this instance, the equation written for a PWM output determines its period and pulse width. A typical Flexible Combiner application consists of three types of components: inputs, equations, and outputs. For more information about this application, see the Flexible Com-

biner manual (*P/N 026-1620*).

11.23 Modular Chiller Control (MCC)

The Modular Chiller Control is available for the E2 RX model controllers version 2.82 and above. In the RX-300, a maximum of one MCC is allowed. In the RX-400, a maximum of two MCCs are allowed.

11.23.1 Overview

A Modular Chiller is made up of a single compressor connected to a brazed plate heat exchanger that provides a chilled water and glycol mixture for cooling display cases and coolers. Multiple Modular Chillers are connected together to meet the capacity requirements of the system. Modular Chillers are designed to provide cooling by paralleling the hydronics side of the secondary system instead of the refrigeration side of the system. These units also use a water and glycol mixture as a condensing fluid for compressor heat of rejection. This design eliminates the long refrigerant piping runs thereby significantly reducing refrigerant charge.

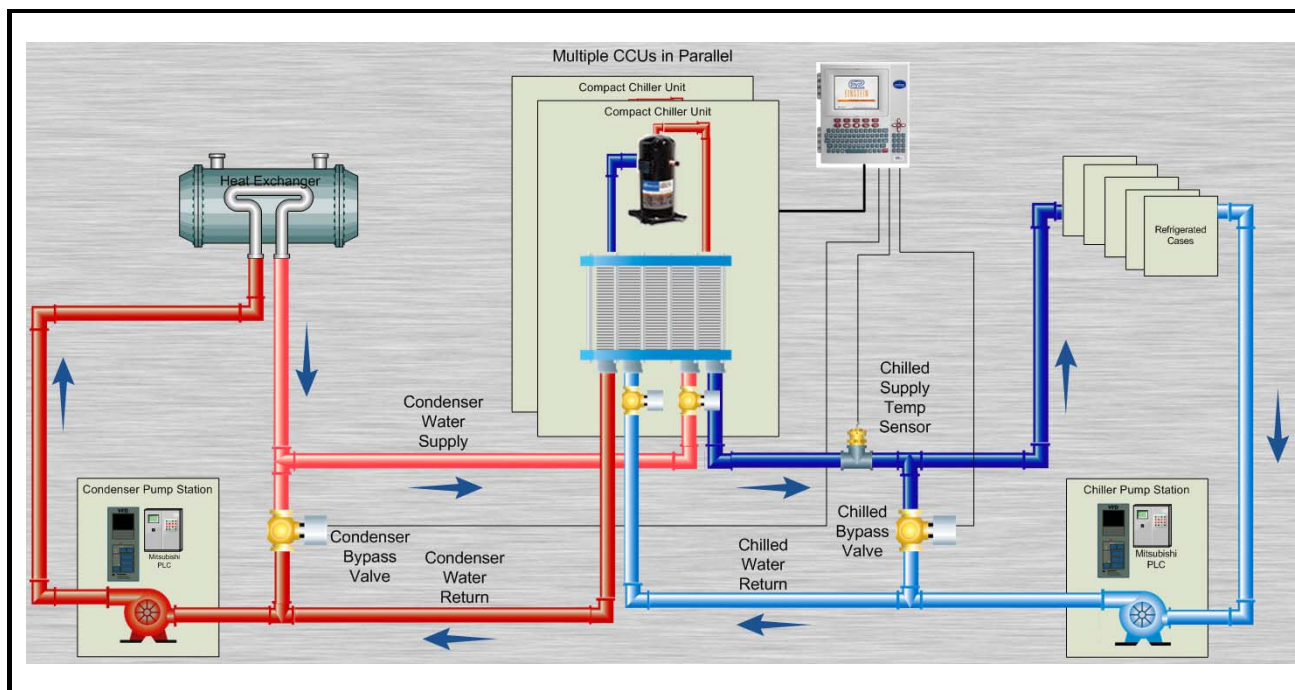

Figure 11-1 - Compact Chiller System

11.23.2 Learning Mode

When an MCC application runs for the first time, it undergoes a "Learning Mode" period to collect data on the chiller stages. During Learning Mode, the MCC will control the chilled water temperature, but it will purposely cycle the chiller stages in different combinations to measure the effect they have on the temperature input value.

The Learning Mode lasts for several minutes. After Learning Mode ends, the MCC will require up to 24 hours of operation before compressor cycling is operating at maximum efficiency. If compressor cycling seems too frequent after 24 hours of operation, you may reduce compressor cycling by changing the Control/Cycles parameter.

11.23.3 The Control/Cycles Parameter

The MCC has one parameter with five preset settings to allow users to alter temperature control performance or compressor cycling frequency. The default setting, "Moderate Control," seeks to balance good temperature control with efficient cycling. If tighter control is needed, setting the field to "Tight Control" or "Tightest Control" will increase the application's reaction to temperature changes, resulting in tighter control (usually at the expense of more frequent cycling). If fewer compressor cycles are desired, setting the field to "Less Cycling" or "Least Cycling" will decrease the number of cycles but also increase the amount of fluctuation in the temperature control.

11.23.4 Compressor Control

MCC can utilize up to 32 compressors for maintaining the chilled supply temperature at a user specified setpoint. This is accomplished by either turning on or off any of the compressors defined in the application. As Supply Temperature rises above setpoint, compressors will be turned ON. As Supply Temperature falls below setpoint, compressors will be turned OFF. The Chilled Supply Temperature sensor should be located very close to the Compressor Control Unit so no minimal control lag is expected to be present.

When a compressor has been shut down on an alarm, the compressor will remain out of the active rotation until the alarm has been cleared. Additionally, the user will have the option of specifying that the alarmed compressor be re-tried the next time it comes up in the rotation. To prevent damage to a compressor, the user will have the option of specifying a number of trips per day before the compressor is permanently locked out. Once this condition has occurred, the compressor alarm will require a manual reset to bring it back into the active rotation.

The controller will monitor the Chilled Differential Pressure and if it falls below a user specified threshold, the controller will start to shut down compressors one at a time based on a user specified time delay. This shutdown operation will be suspended if the Chilled Differential Pressure rises above a user defined setpoint.

11.23.4.1 Digital Scroll Compressor

MCC can also utilize a single Digital Scroll Compressor. The assumption is that one of the Compressor Control Modules in the system may have a digital scroll instead of a standard scroll compressor installed. The Digital Scroll Compressor may not be the same size as the fixed scroll compressors. When a Digital Scroll Compressor is defined in the application, MCC will utilize the compressor control modules with the digital scroll at all times, modulating the capacity of the compressor to maintain the Chilled Supply Temperature setpoint. All other compressor control modules will be turned ON or OFF based on the rotation sequence defined above. Based on this strategy, the digital scroll compressor will have the fewest cycle counts and the most runtime of all the compressors in the system.

11.23.4.2 Variable Frequency Drive Compressor

MCC can utilize one compressor with a variable frequency drive. The method of control will be similar to the digital compressor strategy. The application will continue to allow only one variable capacity device to be defined in the system, making the Variable Frequency Drive and Digital compressor options mutually exclusive.

If a Variable Frequency Drive compressor is to be used and it is a Control Techniques drive using the Modbus communication interface, the Control Techniques Drive association menu will support associating the drive to an MCC.

11.23.4.3 Unequal Capacity Compressors

Optionally, the MCC can support different capacity compressors. When this option is selected, the capacity of each defined compressor will be user specified. The controller will evaluate the capacities of all the compressors to determine the appropriate compressor to switch on or off in order to maintain the Supply Temperature at setpoint.

When unequal capacity compressors are defined, the controller will not use a simple round robin approach to switching compressors on or off (as with equal capacity compressors) and therefore compressor runtimes may vary significantly over time. However, for those compressors defined with identical capacity, the algorithm will attempt to keep both runtimes and cycle counts as even as possible.

11.23.5 Bypass Valve Control

MCC can utilize the Chilled and Condenser Bypass Valves. These valves will be modulated to maintain user defined differential setpoints. For each valve, as the differential pressure rises above the setpoint, the valve will modulate open. When the differential pressure falls below setpoint, the valve will modulate closed.

11.24 Boiler

The BX-300 and BX-400 will default to a maximum of two Boiler applications. Other models will have to license the Boiler Application. The Boiler will be available only for E2 versions 2.85 and higher.

11.24.1 Overview

The Boiler can be controlled two ways, via the boiler temperature or the boiler pressure. The E2 uses the current outside air temperature to calculate a new boiler control setpoint. If the boiler temperature (or boiler pressure) is less than the setpoint value then the boiler is turned ON. Otherwise it is turned OFF. The algorithm will work in an inverted fashion if the Minimum Outside Air Temperature is greater than the Maximum Outside Air Temperature.

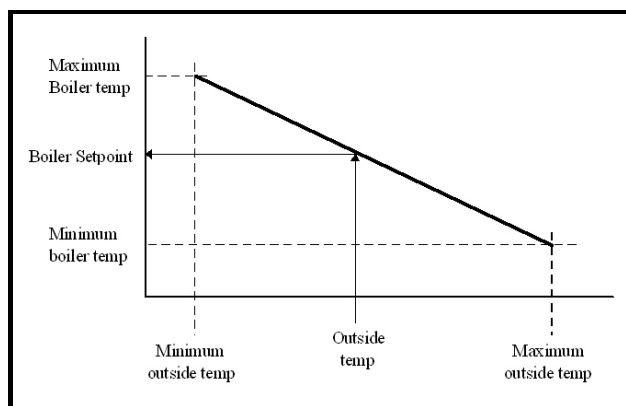

Figure 11-1 - Temperature Ranges

An Outside Air Temperature Boiler On and an Outside Air Temperature Boiler Off can be defined. If the outside air temperature is lower than the Outside Air Temperature Boiler On the boiler is turned ON. If the outside air temperature is higher than the Outside Air Temperature Boiler Off the boiler is turned OFF.

If defined, the Outside Air Temperature Boiler Off must be greater than the Outside Air Temperature Boiler On.

11.24.2 Alarms

There are four advisories generated by the Boiler Application:

- High Temperature
- Low Temperature
- High Pressure
- Low Pressure

Each advisory will have an associated type, priority, and delay.

11.25 Refrigerant Monitoring System (RMS)

The RMS enables the E2 ability to measure the refrigerant used to add, remove and repair an asset that has a refrigerant charge. RMS is available for E2 versions 3.01 and above. The RMS comes with two components that are installed together, the RMS asset and the RMS scale. A total of 99 RMS applications can be supported by the E2. The RMS is a licensed application. For licensing instructions, refer to the software licensing section (see **Section 10.15, License Management**). When an RMS Asset is licensed, this automatically includes one RMS Scale.

11.25.1 RMS Asset

There will be one E2 RMS asset instance for each refrigerant charged asset. A refrigerant-charged asset can include HVAC, Rack, and Small Appliance.

The RMS asset can perform the following functions;

- **Charge Asset** - The asset will be filled with refrigerant. The Cylinder Accumulated Weight and the Total Accumulated Weight will be reset to 0.0. If an RMS Scale is not present, manually input the ending weight and the starting weight of the cylinders. (This applies during charging or reclaim, if more than one cylinder is needed.)
(Note to *cancel* charging, press Enter from the Status screen and select Application Commands, **3**. **Close Ticket**. Enter a reason in the **Tech Comment** field and press F10 to cancel the charge.)
- **Reclaim Refrigerant** - The refrigerant will be removed from the asset. The Cylinder Accumulated Weight and the Total Accumulated Weight will be reset to 0.0. If an RMS Scale is not present, manually input the ending weight and the starting weight of the cylinders. (This applies during charging or reclaim, if more than one cylinder is needed.)
(Note to *cancel* charging, press Enter from the Status screen and select Application Commands, **3**. **Close Ticket**. Enter a reason in the **Tech Comment** field and press F10 to cancel the charge.)
- **Change Cylinder/New Cylinder** - The container of refrigerant will be removed and replaced with a new one. If an RMS Scale is not present, manually input the ending weight and the starting weight of the cylinders. (This applies during charging or reclaim, if more than one cylinder is needed.)
(Note to *cancel* charging, press Enter from the Status screen and select Application Commands, **3**. **Close Ticket**. Enter a reason in the **Tech Comment** field and press F10 to cancel the charge.)

- **Close Ticket** - Select to confirm charging, reclaiming or changing refrigerant. An ending weight, and the total accumulated weight will be displayed. If an RMS Scale is not present, manually input the ending weight and the starting weight of the cylinders. Close Ticket will open the Charge Asset or Reclaim Refrigerant Ticket screen depending on which action is being performed. If adding or removing refrigerant, the refrigerant ticket screen should be filled out. Press F1 to send.
- **Cancel Ticket** - Select to cancel the process. An entry for a reason for cancelling the ticket will be required. An entry will be written to the log.
- **Refrigerant Ticket** - When changing, adding, or removing refrigerant, the RMS Ticket screen for charges or reclaims (depending on whether refrigerant is added or removed) is filled out. Press F1 to send.

11.25.2 RMS Scale

The RMS scale used for weighing the refrigerant tank for a specific asset. The RMS scale communicates using MODBUS. The RMS scale will appear as a device in the device summary list and will be consistent with other devices and their online/offline status.

11.25.2.1 Device Constraints

The RMS scale communicates using the ASCII MODBUS protocol. It can exist on the same MODBUS route as RTU MODBUS devices as long as the baud rate, and serial settings are the same (# of bits, Parity, # of Stop Bits). On a mixed network (RTU and ASCII MODBUS) address 58 is not supported. 58 is the ASCII value for a “:”

11.26 Detailed Setpoint Change Logging

Detailed Setpoint Change Logging stores in a log any setpoints that change, when the setpoint was changed, what the original value was, and what the value was changed to.

The log is always enabled except for start-up and restore and cannot be disabled by the user. This data is retrieved and displayed on the E2 front panel.

11.26.1 Log Information

The following information will be stored for detailed setpoint change logging:

- **Time Stamp** – the time and date of the setpoint change in local time.

- **Port** – the port the change was made through.
- **User** – the user name.
- **Application Name** – the name of the cell that was changed.
- **Property Name** – The name of the property that was changed.
- **FromValue** – The value of the setpoint
- **To Value** – The new value of the setpoint

11.26.2 Logged Changes

A log will be appended with changes as they occur:

- Any setpoints that are directly changed by a user.
- Custom property values that are changed. These properties are changed by the system as a result of a user changing a value. These will be logged as changed by the user.
- Application inputs that are set as fixed values and changed by user.
- User Associations
- Changes in input/output pointers.

11.26.3 Unlogged Changes

There are some kinds of changes that occur that will *not* have logs created for them:

- User overrides – Overrides are input/output changes to the value outside of the setup screen or application control.
- Real-time value on cell inputs that are connected to other application outputs.

12 Operator's Guide to Using the E2

12.1 The E2 Home Screen

The Main Status or Home screen (*Figure 12-1* and *Figure 12-2*) is divided into sections that display the current status in areas of importance in the system (i.e., for RX: suction groups, compressor stages active, circuits, condensers, sensor control, and for BX: OAT, demand control, power monitoring, light schedules, zones, AHUs, and sensor control). Time, date, and alarm status are displayed along the top of the screen. The display is backlit, but turns off to save energy after a determined amount of time. Press any key to bring the display back up.

The Home screen acts as a master and default screen for all the functions of E2 and can be customized according to the user's needs (see *Section 12.5, Customizing the Home Screen*).

12.1.1 RX Home Screen

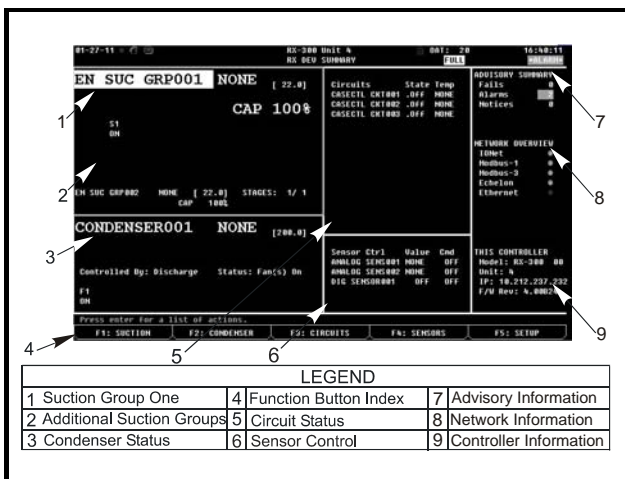

Figure 12-1 - RX Home Screen

Suction Groups Section

The first section of the RX Home screen is the Suction Groups section located in the top left corner. The large letters have the name of Suction Group 1 along with information on compressor stages active, and the current pressure setpoint. Setpoints, status, percentages of capacities, and which stages are active for each suction group are displayed as well. The suction group that is displayed in the large block at the top left of the screen is the group that is named *alphabetically* first of the suction groups.

Circuit Status Section

To the right of the Suction Groups section is the Circuit Status section. Both the Standard Circuits and the Case

Controllers are listed in this screen. The circuit names, their current status, and temperatures are listed.

Condenser Section

This section is located at the bottom left of the screen and contains information on the status of the condenser, such as the discharge setpoint and individual fan states.

Sensor Control

Below the Circuits section at the bottom right of the screen is the Sensor Control section where Control Value and Command information are displayed.

12.1.2 BX Home Screen

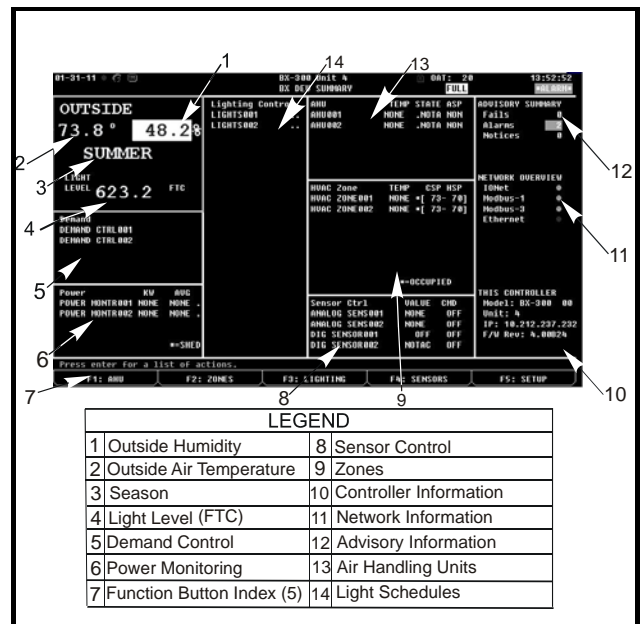

Figure 12-2 - BX Home Screen

OAT Section

The upper-left hand section of the BX Home screen contains status information for four different values, including outside air temperature, humidity percentage, season, and light level.

Demand Control Section

Directly below the OAT section is demand control status information, which shows the number of applications and number of loads being shed.

Power Monitoring Section

In the lowest left-hand corner of the BX Home screen is the power monitoring section, containing active KW and average power information.

Light Schedules Section

In the center of the BX Home screen is ON and OFF status information for light schedules.

Air Handling Units Section

Located at the top right-hand corner of the BX Home screen, the AHU section shows the number of AHUs, temperature, state, and ASP information for each.

Zones Section

Directly below the AHU section is the Zones section, which shows the number of zones, temperature, whether or not the application is in occupied mode, CSP and HSP.

Sensor Control Section

Sensor Control is at the bottom right-hand corner of the BX Home screen and contains analog and digital sensors, value, command, and status information.

12.1.3 CX Home Screen

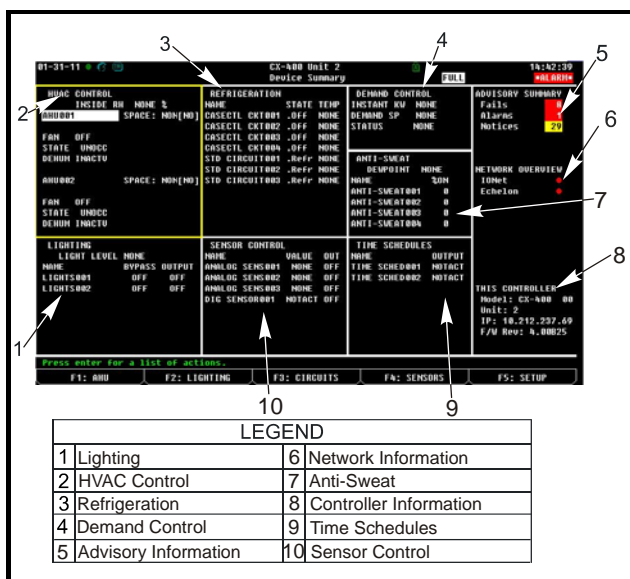

Figure 12-3 - CX Home Screen

Lighting Control Section

The lower left-hand corner of the screen shows name and bypass output for the lighting circuits.

HVAC Control Section

The top left-hand corner of the screen shows whether the fans are ON or OFF, state, and dehumidification status of the first two air handlers in the sequence.

Refrigeration Control Section

The top center of the screen shows the name, state, and current temperature of standard circuits.

Demand Control Section

The top right-hand corner of the screen shows the status of the Demand Control application.

Anti-Sweat Control Section

The middle right-hand section of the screen shows name and percent ON information for each anti-sweat application.

Sensor Control Section

The bottom center section of the screen shows both analog and digital sensor control, name, and command output.

Time Schedules Section

The lower right-hand section of the screen shows the name and current status of time schedules.

12.2 Logging On and Access Levels

An E2 may be programmed with up to 25 different users. A user basically consists of a username, a password, and an access level. Whenever a username and password are entered during login, the E2 searches the user records for the username and password. If found, the E2 will log the user in at the access level configured for the user in the user records.

The access level determines how many of the E2's features the user may use. The E2 uses four access levels, one being the lowest, and four being the highest. **Table 12-1** gives a description of each level and the capabilities they have access to.





Level 1	Read-only access. Users may generally only view status screens, setpoints, and some system settings.
Level 2	Setpoint and bypass access. Users may perform all the tasks a level 1 user may, and they may also change control setpoints and bypass some devices.
Level 3	Configuration and override access. Users may perform all the tasks a level 2 user may, and they may also override system settings, create new cells, and program new applications.
Level 4	System Administrator access. All E2 functions are accessible by a level 4 user.

Table 12-1 - User Access Levels

12.3 Toggling Full Options

Toggling Full Options on allows you to have full access to programming applications. To Toggle Full

Options on:

1. Press the  key
2. Select  (System Configuration)
3. Select  (System Information)
4. Select  (Toggle Full Options)

FULL will appear in the top right corner of the screen when Full Options is enabled. Pressing  toggles Full Options on and off.

12.4 Navigation

12.4.1 Menus

Main Menu

The Main Menu is accessed by pressing the  key. This menu gives you direct access to applications such as Suction Groups, Condensers, Circuits, Air Handling Units, Zones, Light Schedules, and Sensor Controls applications, (depending on which controller type you are using) as well as all configured applications in the controller. The Main Menu also allows you to add and delete applications, gives system configuration abilities, and shows status information for inputs and outputs, network, graphs and logs.

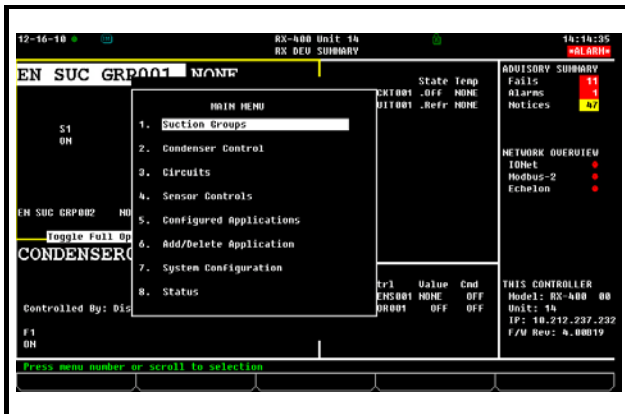

Figure 12-4 - Main Menu

The System Configuration Menu

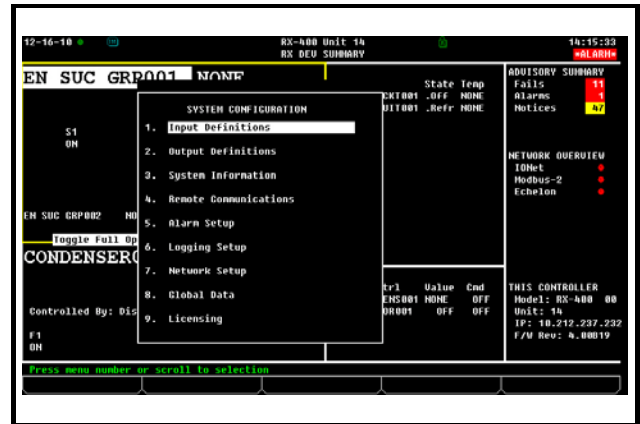

Figure 12-5 - System Configuration Menu

The System Configuration Menu is one of the menus used to set up the E2. Included options are Input/Output Definitions, internal system information, remote communications, global data, alarm, logging, and network setup information.

To open the System Configuration menu:

1. Press 
2. Press  (System Configuration)

The System Configuration menu contains nine menu items:

Menu Option	Description
1 - Input Definitions	View the status of all input boards, as well as set up individual points on the I/O boards.
2 - Output Definitions	View the status of all output boards, as well as set up individual points on the I/O boards.
3 - System Information	Menu that gives access to more E2 setup options and information.
4 - Remote Communications	Gives access to modem information, dial-out setup, and TCP/IP.

Table 12-2 - System Configuration Menu Options

Menu Option	Description
5 - Alarm Setup	Set up dial-outs and alarm reporting for the current E2.
6 - Logging Setup	Enter information about Logging Group applications such as the sampling frequency and total number of samples.
7 - Network Setup	Accesses the Network Setup menu where you can view and/or change the configuration of the Echelon and RS485 I/O Networks, set up boards, controllers, routers, and make controller associations.
8 - Global Data	Configure one or more analog or digital sensors to be used as “global” values by all E2s.
9 - Licensing	Select this option to access the License Report screen that lists all the applications in E2 that are currently licensed and the number of each type of applications that are in use. You can also add additional licenses by pressing F1.

Table 12-2 - System Configuration Menu Options

The System Information Menu

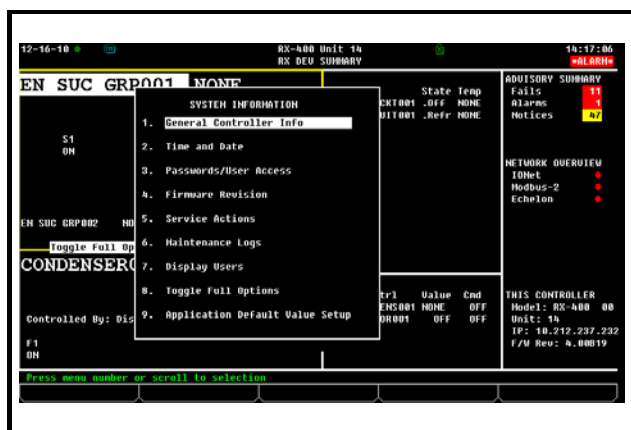

Figure 12-6 - System Information Menu

The System Information menu is used to set up the E2. The options in this menu allow setting up time and date, passwords, toggle full options, general information about the controller, and other important data.

The System Information Menu is another menu used to set up the E2. The options in this menu allow setting up time and date, passwords, toggle full options, general

information about the controller, and other important data.

To open the System Information Menu:

1. Press
2. Press (System Configuration)
3. Press (System Information)

The System Information menu contains nine menu items:

Menu Option	Description
1 - General Controller Info	Edit general information about the E2, such as engineering units, and summer/winter change-over specifications.
2 - Time and Date	Change the current date and time, and specify date formats.
3 - Passwords/User Access	Set up usernames and passwords, and define security level requirements.
4 - Firmware Revision	Read-only information screen that contains current system version information
5 - Service Actions	Set up system diagnostics (memory and execution info), and perform advanced functions (system resets and firmware update).
6 - Note Pad	Writable field for technician to make notes about changes made or general information.
7 - Display Users	Enter information about Logging Group applications such as the sampling frequency and total number of samples.
8 - Toggle Full Options	When set to on, FULL will appear at the top right of the screen and gives user full access to options and applications.
9 - Application Default Value Setup	Choose the default values most appropriate to the refrigeration control components in the system.

Table 12-3 - System Information Menu Options

Actions Menu

Functions such as graphing, point logging, overriding, expanded information, setup, detailed status, and manual defrosting can be initiated from the Actions Menu box by pressing the key from the Home screen or any sta-

tus screen. When you press the Enter key, only the options that are appropriate to the current field and application will be displayed; all others will be hidden.

For example, if Enter is pressed when a circuit is highlighted, the Actions Menu would display all available options for that circuit, such as Manual Defrost, meaning that by selecting Manual Defrost the Manual Defrost screen would come up for that particular circuit.



Figure 12-7 - Example Actions Menu for Standard Circuit

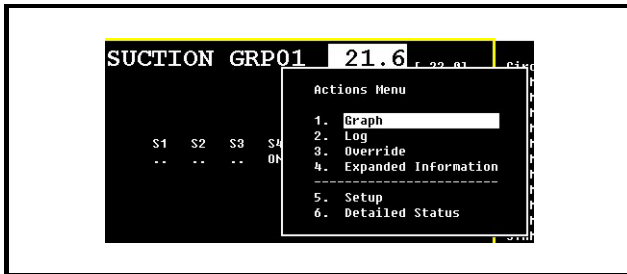

Figure 12-8 - Example Actions Menu for Suction Group Value

12.4.2 Screen Types

Summary Screens

Summary screens let you view status information for multiple applications of the same type. For example, (Figure 12-9) is the Circuits Summary screen in the E2 RX controller. This screen shows the name, state, temperature, setpoint, alarm, refrigeration, and defrost information for all defined standard and case control circuits displayed. To see a more detailed status when on an application summary screen, highlight the desired application from the list with the arrow keys and press . This will take you to the Status screen.

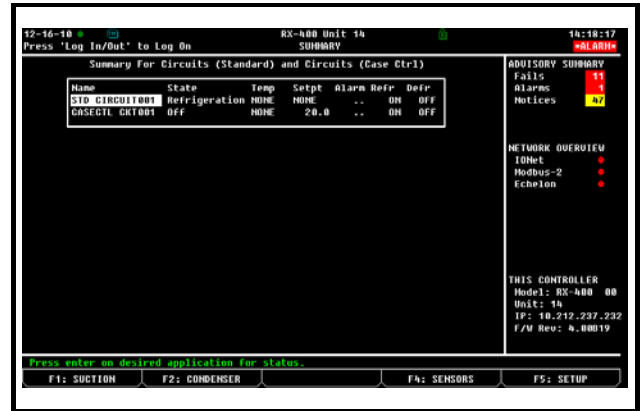

Figure 12-9 - Summary Screen (RX-400 Version Shown)

Status Screens

Status screens are real-time views of application functions. They show the current status of all outputs, the current values of all inputs, and other important data such as control setpoints, run times, and whether or not bypasses or overrides are active.

Each status screen is specially designed to provide a concise at-a-glance view of how one or more systems are functioning.

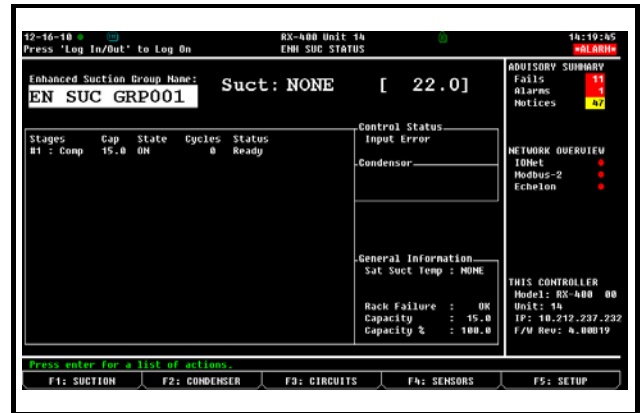

Figure 12-10 - Status Screen (RX-400 Version Shown)

Setup Screens

The Setup utility is the interface used to change settings and setpoints, and define inputs and outputs in the E2. Figure 10-11 shows a typical Setup screen and its primary elements.

Index Tabs:

status, and more.

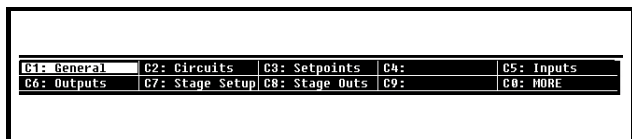

Figure 12-11 - Index Tabs (RX-400 Version Shown)

The 10 boxes at the top of the screen labeled **C1** through **C0** are known as the index tabs. These tabs provide you with a short index of the screens that are used to set up an application. **C1** through **C0** represent the screen numbers (**C1** being screen 1, **C2** being screen 2, and so on.) Press the **Ctrl** key and the number of the index tab (next to the **C**) and the cursor highlights that index tab.

Each of the Setup screens that you may access will have a name beside its number. In **Figure 10-11**, for example, you will notice some tabs have names, while others are blank. This is because there are only four screens in the Setup for this particular application; **C3** is not an accessible screen.

There are several reasons why a tab may be inaccessible (i.e., without a name next to the number):

- The tab (and the corresponding screen) is unused and reserved for later revisions.
- The screen may only be accessed when running in Full Options mode (see **Section 12.2, Logging On and Access Levels**).
- The screen may require one or more fields to be set to certain values before the screen may be accessed. For example, a screen containing nothing but compressor proof input definitions might be hidden if there is a field on another screen that tells the system there are no proof checking devices on the group's compressors. To access this screen, you would have to set this field to **YES**.

The screen you are currently in is always highlighted in the screen's index tab. For example, because Screen 1 is displayed, tab **C1** is highlighted.

As you move to other screens within Setup, the highlight will move to different tabs to indicate which screen will be displayed.

Header Icons:



Figure 12-12 - Header Icons

At the very top of every screen in the E2, there are icons that indicate various stages of activity, number of users logged into the controller, battery alerts, connectivity

Icon	Description
	Single user is logged in
	Multi-users are logged in
	Terminal mode in use
	E2 is connected to Ethernet
	Wait, or system is busy
	Disk activity, or saving to disk
	Caps lock is ON

Table 12-4 - Header Icons and Descriptions

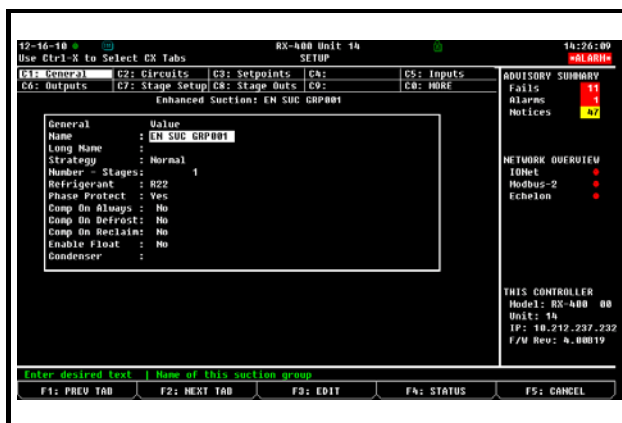

Figure 12-13 - Setup Screen (RX-400 Version Shown)

12.4.3 The E2 Keypad



The Cursor

The cursor highlights individual fields on the E2 screen, allowing you to change their contents and/or select them to perform other functions like viewing logs/graphs or setting alarm parameters. The E2 includes arrow keys for the user to easily navigate the cursor around each screen. Areas can be accessed for detailed information and certain functions by guiding the cursor with the arrow keys.

The Tab Key

When an E2 screen is split into multiple areas (like the default Main Status screen), the Tab key moves the cursor to each section of the current screen. The border around each section is highlighted by the cursor so the user will know which section the cursor is on.

The Enter Key

Pressing the  key from the Home screen or any application status screen will pop up the **Actions Menu**. If an option is highlighted when  is pressed, that highlighted option is selected. Pressing  on an application summary screen will bring you to the status screen of that application.

Keypad





Key	RX and BX Function	Description
	PREV TAB	Moves backward one screen
	NEXT TAB	Moves forward one screen
	EDIT	Opens the Edit Menu box
	STATUS, OVERRIDE, or LOOK UP	Opens the Detailed Status screen, Opens the Override Update screen, or Look Up Tables
	SETUP, or CANCEL	Opens the Setup screens, or Cancels an operation

Table 12-5 - Function Keys for Setup Screens





Key	RX Function	BX Function
	SUCTION GROUP	AHU
	CONDENSERS	ZONES
	STANDARD and CASE CIRCUITS	LIGHTING
	SENSOR CONTROL, POWER MONITORING	SENSORS
	SETUP, CANCEL	SETUP, CANCEL

Table 12-6 - Function Keys for Status Screens



















Key	Function
	The Help key opens the Help menu
	The Alarms key opens the Alarms Advisory Log
	The Home key opens the Home screen
	The Menu key opens the Main Menu
	The Back key moves you back to the previous screen

Table 12-7 - Icon Function Keys

- The Help  key opens a pop-up window containing either information about the screen or menu you are currently on, or information about the input, output, or setpoint you have highlighted with the cursor (if available). After the Help  key has been pressed,  will open the General Help menu containing Troubleshooting options. Press the  and  keys together at any time to open General Help.
- The Alarms  key displays the alarm advisory log that shows all the current alarms in the E2.
- When the Home  key is pressed from any location, the Home screen opens.
- When the Menu  key is pressed from any location, the Main Menu opens.
- The Back  key will take you to the previous screen.

Pressing  from an application status screen, Home screen, or Input/Output Status screen brings up the Actions Menu and gives the user access to controller functions such as graphing, logging, setup, and detailed status.

The Log In/Out Key

The Log In/Out  key brings up the current E2 User Login Screen when logging in. If the Log In/Out  key is pressed in order to log out and there is data on the screen that has been edited and not saved, a dialog box opens asking if the data should be saved. If **Yes** is selected, the data is saved, the user is logged out and returned to the Home screen. If **No** is selected, the dialog box closes and the screen is refreshed as necessary. Pressing the Log In/Out  key in order to log out when no data needs to be saved simply logs the user out and returns to the Home screen.

Four Directional Arrow Keys

Directional arrow keys move the cursor in the direction of the arrow pressed. The arrow keys are always functional on menus and can be used to move from section to section on the Home and Status screens.

Page Up/Page Down Keys

The Page Up and Page Down keys scroll the user through menus, application summary screens, and setup screens too large to fit on one screen.

Ctrl Page Up/Ctrl Page Down Keys

The Ctrl Page Up or Ctrl Page Down keys on an application setup screen take the user to the next or previous application on the same screen.

Numeric Keypad

The numeric keypad is fully functional from both the front panel and an external keyboard.

Hot Keys

Hot Keys are quick and easy shortcuts to frequently used functions and applications. For a complete menu screen that lists all Hot Keys and how to access them, press the key and the key together.

Use the control keys to access Insert Mode, Edit Mode, and Names. Pressing and (INS will appear on the top right of the screen) activates Insert Mode. Insert Mode toggles between Insert and Overwrite edit modes. Pressing and (ED will appear on the top right of the screen) activates Edit Mode. Edit Mode allows you to change the name of the application to something besides the name of the application and the number. Pressing and (NAMES will appear on the top right of the screen) switches from a Point number to a Point Name when setting up Board and Points in a Setup screen.

Keys	Function
Application	
+	All Applications
+	AHU Summary
+	Time Schedule Summary
+	Sensor Control Summary
+	Lighting Control
+	Power Monitoring
+	ARTC/RTU Summary
+	HVAC Zones Summary
+	Suction Summary
+	Case Control Summary
+	TD3 summary
+	Case Control Summary
+	Condenser Summary
+	Time Schedule Summary
+	Sensor Control Summary
+	Power Monitoring
+	Suction Summary
+	Circuit Summary
General	
+	Global Data Status
+	Expanded Info
+	Graph Current Application
+	Input Definitions
+	Output Definitions
+	Log Current Application
+	Maintenance Log
System	
+	Add/Delete Application

Table 12-8 - Shortcut Keys

Keys	Function
Alt + F	Toggle Full Options
Alt + M	Serial Setup
Alt + N	Network Status
Alt + T	TCP/IP setup
Alt + V	Firmware Version
Alt + =	System Logs and Stats
Edit	
Ctrl + E	Edit Mode
Ctrl + I	Insert Mode
Ctrl + N	Names Mode





Table 12-8 - Shortcut Keys

12.5 Customizing the Home Screen

The Home screen can be customized to show different information depending on the user's needs. If you wish to change the Home screen from the default screen, follow the steps below. There are eight different screen options available with the **Device Summary** screen as the default choice.





NOTE: Toggle Full Options must be on in order to customize the Home screen. FULL will appear at the top right of your screen when Full Options are enabled. To toggle quickly to Full Options, press the Alt key and F together.

1. Press the  button to open the Main Menu screen.
2. Press  for the System Configuration screen.
3. Press  for the System Information screen.
4. Press  for General Controller Info and scroll down to **RX Home Screen** or **BX Home Screen** depending on which controller you are using.
5. Press  (LOOK UP) to open the Option List Selection menu.
6. Choose the desired Home screen from the list.
7. Log off to save changes.

12.6 Manual Defrost and Clean Mode

A circuit can be placed in manual defrost from the RX Home screen or a Circuit Status screen. If a refrigeration circuit needs to be placed in manual defrost, follow these steps:

1. Press  (CIRCUITS) to go to the Circuits Status screen, or place the cursor on the desired circuit from the Home screen and press  to open the Actions Menu. Select **Manual Defrost**.
2. Once inside a Circuits Status screen, press  to open the Actions menu.
3. Select **Manual Defrost** from the list and the Cir-

circuit Bypass screen opens.

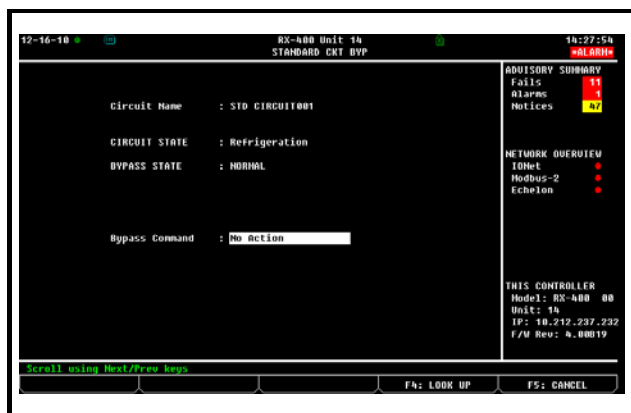

Figure 12-14 - Circuit Bypass Screen (RX-400 Version Shown)

- The Circuit Bypass screen (see Figure 12-14) will display the circuit name, its current state, and the bypass state. The **Bypass Command** field will be highlighted.

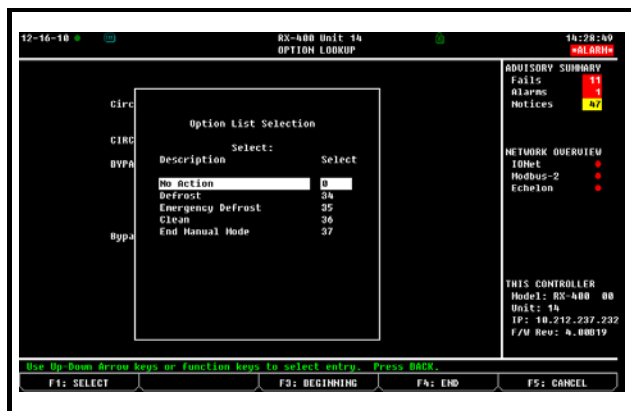

Figure 12-15 - Option List Selection Screen

- Press **F4** LOOK UP. The Option List Selection screen (see Figure 12-15) will give you five choices of defrost modes.
 - No Action** - Normal (no manual defrost) state.
 - Defrost** - This is the normal defrost mode. The defrost ends according to the terminating device (sensor) or fail-safe time, whichever occurs first.
 - Emergency Defrost** - The defrost time goes the full duration of programmed defrost time and ignores any defrost termination sensors.
 - Clean** - This mode disables all refrigeration and defrost so that the case can be cleaned or serviced.

NOTE: If the case circuit has been placed in Clean Mode, it must be taken out of Clean Mode. Follow the procedures up to the Option List menu and choose “End Manual Mode.”

- End Manual Mode** - Selecting this command will end any defrost cycle or the Clean Mode initiated manually.

If the defrost time needed is shorter than what the normal programmed defrost time allows or if in Clean Mode, follow the procedures to the Option List menu and select **End Manual Mode**.

12.7 Overrides

If a compressor stage or a fan on the condenser needs to be bypassed, follow these instructions:

- From the default Home screen, arrow to either the **COMPRESSOR STGS** or **FAN STAGES** sections and highlight the stage or fan to be bypassed. Press Enter to access the override option from the menu.

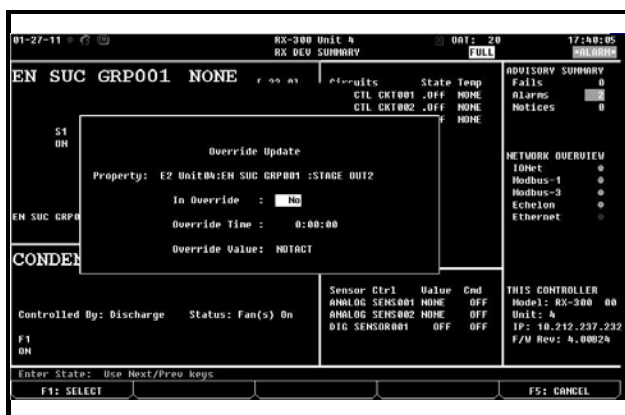

Figure 12-16 - Override Update Screen (RX Version Shown)

- The Override Update screen appears (see Figure 12-16). Press the **Prev** or **Next** to enter **Yes** to place the stage in override. Scroll down one space to enter the **Override Time**.
- Choose the **Override Value** of either **OFF** or **ON** using **Prev** or **Next**.

The compressor stage or condenser fan stage in override mode will be marked with a cyan blue background in the Main Status screen indicating that the override is in effect.

12.8 Checking Boards Online

Name	Type	Network Address	Rev	Status
E2 Unit14	RS400-Refrig	Ethernet: 14	4.00019	This Controller
CASE DISP_001	100-Case Display	00050330000	2	0.00 Online
EC2 391 CC_001	EC2-39X Control		0	0.00 Offline
1001_001	1001	IONet:	1	0.00 Offline
800_001	800	IONet:	1	0.00 Offline
800_001	800	IONet:	1	0.00 Offline
CL RSC_001	CtrlLink RSC	Modbus-2:	1	4.10003 Online
ESD EOP_001	ESD 2.0 Comp	Modbus-2:	-	0.00 Unknown
DISCUS_001	Discus	Modbus-2:	-	0.00 Unknown
XR75CX001	XR75CX	Modbus-2:	0	0.00 No Part
XR75CX001	XR75CX	Modbus-2:	0	0.00 No Part
E2 Unit01	RS400-Refrig	Ethernet: 1	3.00017	Offline

Figure 12-17 - Network Summary Screen

You can check all boards that are on either the Echelon Network (E2 controllers) or the I/O Network from the Network Summary screen (See *Figure 12-17*). This screen displays information such as board status, name of the device, type of device (board, controller, etc.), firmware revision, the network address for each device, the number of Echelon controllers (E2s) that are online or offline, and the number of I/O boards online or offline. After determining which board is offline, turn to *Appendix F: Troubleshooting* for more information.

To access the Network Summary screen:

1. From the Main Menu screen, press **8** (Status) for the Status menu.
2. Press **3** (Network Summary) and the Network Summary screen will be displayed.

The Network Summary screen can also be accessed by:

1. From the Main Menu screen, press **7** (System Configuration).
2. Press **7** (Network Setup) for the Network Setup menu.
3. Select **1** (Network Summary) and the Network Summary screen opens.

NOTE: Jump directly to the Network Summary screen by pressing the **Alt** and **N** keys together. For a complete list of Hot Keys, press the **Alt** and the **?** keys together.

12.9 Checking Status Screens



Figure 12-18 - RX Function Button Menu

The E2 RX controller has four status screens that are each accessible (from the Home screen) by pressing the corresponding function key (see *Figure 12-18*). The Suction Group status screen, the Condenser status screen, the Circuits status screen, and the Sensors status screen can all be accessed by pressing one of the function keys (**F1** - **F4**) if the application has been added to the E2.

Suction Group Status Screen

Press **F1**. The suction group selected will be displayed with information such as active stages, discharge temperature, current setpoint, associated condenser, and other general information.

Condenser Status Screen

Press **F2**. Information on the condenser such as control setpoints, detailed fan status, and other general information will be displayed.

Circuit Status Screen

Press **F3**. Select which circuit status to view with the arrow buttons and press **Enter**. Information such as current temperature, current state, individual case information, and other information are given.

Sensor Status Screen

Press **F4**. Select an analog or digital sensor and press **Enter**. Information such as control value, and command values will be displayed. The analog sensor will have Cut In/Cut Out temperature values.



Figure 12-19 - BX Function Button Menu

The E2 BX controller has four status screens that are each accessible (from the Home screen) by pressing the corresponding function key.

AHU Status Screen

Press **F1**. The AHU information such as control temperature, season mode, space humidity, apparent temperature, heat/cool mode, fan state, economization status, dehumidification, and humidity status are all included on this screen.

Zones Status Screen

Press **F2**. Zone information including outdoor and zone temperature, outdoor humidity, season mode, occupied state, and economization status are displayed in the Zone Status screen.

Lighting Status Screen

Press **F3**. Lighting status information can be found on this screen. Check light level, bypass, and other modes from here.

Sensors Status Screen

Press **F4**. Select an analog or digital sensor and press **Enter**. Information such as control value, and command values will be displayed. The analog sensor will have Cut In/Cut Out temperature values.

Other Status Screens

Other status screens in the E2 controller may be accessed by selecting **5** (Configured Applications) from the Main Menu. This menu gives you access to Summary and Status screens such as Anti-Sweat, Power Monitoring, Time Schedules, Holidays, and many more. To gain access to any of the given applications, select the corresponding number and press **Enter**.

12.10 Alarms

This section describes how to view and use the Alarm Advisory Log.

12.10.1 Accessing the Alarm Advisory Log

The Alarm Advisory Log can be accessed by pressing the alarm icon key  on the controller.

12.10.2 Viewing the Controller Advisory Log

The current number of advisory log entries (the log that is highlighted) is displayed at the top right of the Advisory Log Screen. The total number of alarms and/or notices in the Advisory Log is displayed below the current field. To move between Advisory Log entries, press the up or down arrow key.

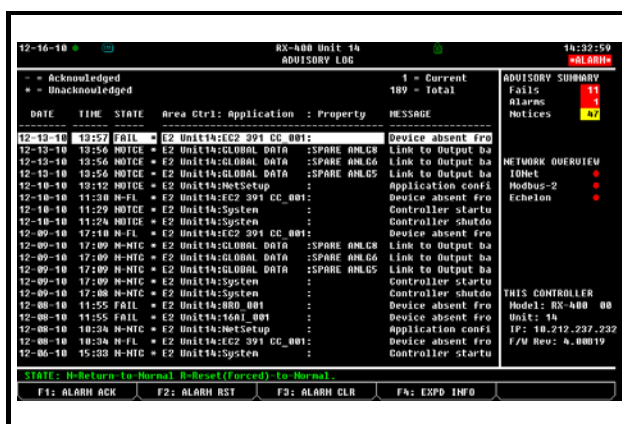

DATE	TIME	STATE	Area Ctrl:	Application	Property	MESSAGE
12-10-10	10:57	FAIL	E2 Unit1A	IC2 391 CC 001		Device absent fro
12-10-10	10:59	NOTICE	E2 Unit1A	GLOBAL DATA	:SPARE ANL G5	Link to Output ba
12-10-10	10:56	NOTICE	E2 Unit1A	GLOBAL DATA	:SPARE ANL G6	Link to Output ba
12-10-10	10:56	NOTICE	E2 Unit1A	GLOBAL DATA	:SPARE ANL G5	Link to Output ba
12-10-10	10:12	NOTICE	E2 Unit1A	NetSetup		application confi
12-10-10	11:20	N-FIL	E2 Unit1A	IC2 391 CC 001		Device absent fro
12-10-10	11:29	NOTICE	E2 Unit1A	System		Controller startu
12-10-10	11:24	NOTICE	E2 Unit1A	System		Controller shutdo
12-09-10	17:10	N-FIL	E2 Unit1A	IC2 391 CC 001		Device absent fro
12-09-10	17:09	N-MTC	E2 Unit1A	GLOBAL DATA	:SPARE ANL G5	Link to Output ba
12-09-10	17:09	N-MTC	E2 Unit1A	GLOBAL DATA	:SPARE ANL G6	Link to Output ba
12-09-10	17:09	N-MTC	E2 Unit1A	GLOBAL DATA	:SPARE ANL G5	Link to Output ba
12-09-10	17:09	N-MTC	E2 Unit1A	System		Controller startu
12-09-10	17:09	N-MTC	E2 Unit1A	System		Controller shutdo
12-08-10	11:55	FAIL	E2 Unit1A	BR0 001		Device absent fro
12-08-10	11:55	FAIL	E2 Unit1A	1601 001		Device absent fro
12-08-10	10:34	N-MTC	E2 Unit1A	NetSetup		application confi
12-08-10	10:29	N-FIL	E2 Unit1A	IC2 391 CC 001		Device absent fro
12-06-10	15:30	N-MTC	E2 Unit1A	System		Controller startu

Figure 12-20 - Alarm Advisory Log

The Advisory Log is divided these categories:

- Date
- Time
- State
- Area Ctrl: Application: Property
- Message

12.10.3 Date and Time

The Date and Time columns simply display the date and time when the alarm or notice was generated and logged into the controller.

12.10.4 State

The State column describes the alarm type, the current alarm state, and whether or not the alarm has been acknowledged. There are three possible alarm states:

- **ALARM** - A high-priority warning, usually signifying a condition that requires attention.
- **NOTICE** - A low-priority message, usually signifying a condition or a system change that requires no attention or may require attention in the future.
- **FAIL** - A failure is a special message that signifies a failure in an E2 system, an application, or in an input or output device controlled by an application (such as a sensor or fan). Returned-To-Normal and

Forced-To-Normal Alarms

For as long as the condition that caused the alarm message exists, the State field will show either **ALARM**, **NOTICE**, or **FAIL** as appropriate to the alarm type. However, if the condition that caused the alarm, notice, or failure is corrected, the message shown in the State field will change to signify the correction.

There are two ways an alarm, notice, or failure condition may be corrected:

- **Return-To-Normal** - “Return-To-Normal” means the condition that generated the alarm, notice, or failure has returned to normal on its own, or the E2 has automatically corrected the condition. If an alarm returns to normal, a “N-” will appear in front of the alarm state in the State field.
- **Reset (Forced)-To-Normal** - “Reset-To-Normal” means the E2 has been forced by a user to consider the condition “normalized” for purposes of alarm control. A Reset-To-Normal occurs when an alarm is reset using the Alarm Reset button **F2** (ALARM RST). If an alarm is forced to normal, an “R-” will appear in front of the alarm state in the State field.

Table 12-9 lists the nine possible state messages as they appear in the State field.

Advisory Type	Condition Still Exists	Condition Returned To Normal	Condition Reset to Normal
Alarms	ALARM	N-ALM	R-ALM
Notices	NOTICE	N-NTC	R-NTC
Failures	FAIL	N-FL	R-FL

Table 12-9 - Alarm States

12.10.5 Ack/Reset State

The State field also shows whether or not an advisory record has been acknowledged or reset by a user. If an alarm has been acknowledged or reset, a dash “—” will appear at the end of the State field. If an alarm has not been acknowledged or reset, an asterisk “*” will appear at the end of the State field.

12.10.6 Area Ctrl: Application: Property

This column describes where the alarm, notice, or failure was generated from. Alarms and notices can either be generated within the E2 system or from an input value that is higher or lower than an alarm or notice setpoint defined during the system configuration process.

12.10.7 Advisory Message

The Advisory Message column is a brief description of the alarm, notice, or failure. Because of screen size constraints, it is often the case that the full advisory message will not be displayed in the Message field. To view the full advisory message, as well as the alarm priority and other important alarm information, press **F4** (EXPD INFO) for Expanded Information.

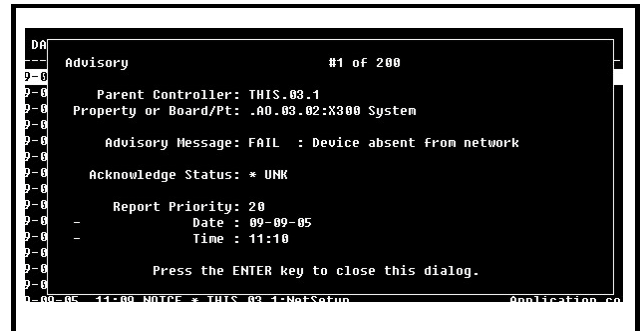

Figure 12-21 - Expanded Info Screen

12.10.8 Acknowledging, Resetting, and Clearing Log Entries

12.10.8.1 Acknowledging

When an alarm, notice, or failure is **acknowledged**, the alarm stays in the Alarm Log, but all annunciation of the alarm is suspended until the alarm is reset or cleared. As stated in **Section 12.10.5**, the state of the alarm or notice will also change to a dash “—” indicating acknowledgement.

When you acknowledge an alarm, you prevent it from ever annunciating again in any way until you **manually** reset or clear the alarm. A condition that causes an alarm will never automatically return to normal when it is acknowledged.

For setting acknowledging permissions, see **Section 10.12.1, Changing Required User Access Levels**.

TIPS: ACKNOWLEDGEMENT VS. RESETTING

- **Reset** an alarm if you believe the condition that caused it is fixed, but you wish for a new alarm to occur if the problem happens again.
- You **MUST reset** an alarm that has been previously acknowledged to re-enable alarming for the alarm. Failure to do so will cause the alarm to remain in ACK, and the alarm will not be generated again. **AN ACKNOWLEDGED ALARM WILL NOT AUTOMATICALLY RESET.**
- **Acknowledge** an alarm to silence alarm panel horns or lights, **ONLY IF** technicians have been notified of the problem and have been dispatched. Technicians, after fixing the problem, **MUST reset or clear the alarm to re-enable alarming.**

To acknowledge an alarm or notice, highlight the desired log entry and press **F1** (ALARM ACK). A screen will come up prompting the user to either acknowledge the selected advisory, acknowledge all advisories, or to cancel the operation.

- Press **A** to acknowledge the selected advisory.
- Press **B** to acknowledge all advisories.
- Press **C** to cancel the operation.

12.10.8.2 Resetting

When a log entry is reset, it is forced to a normal condition and the log entry remains in the Controller Advisory Log.

An alarm, notice, or failure can be reset by highlighting a log entry and pressing **F2** (ALARM RST) while at the Advisory Log screen. A screen will come up prompting the user to either reset the selected advisory, reset all advisories or to cancel the operation.

1. Press **A** to reset the selected advisory.
2. Press **B** to reset all advisories.
3. Press **C** to cancel the operation.

12.10.8.3 Clearing

The option to clear logs completely removes a log entry from the Advisory Log.

Advisory Log entries may be cleared by highlighting the log entry and pressing **F3** (ALARM CLR) while viewing the Advisory Log screen. A screen will come up

prompting the user to either clear the selected advisory, clear all advisories or to cancel the operation.

1. Press **A** to clear the selected advisory.
2. Press **B** to clear all advisories.
3. Press **C** to cancel the operation. Expanded Advisory Information

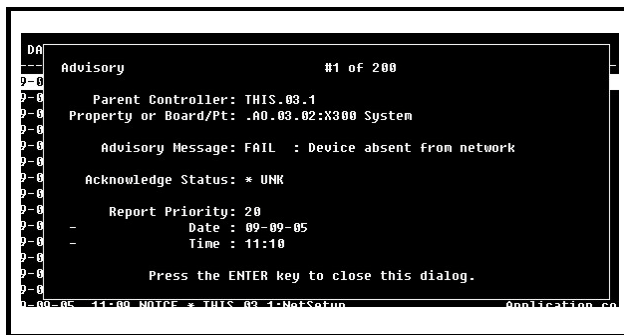

Figure 12-22 - Expanded Info Screen

To view expanded information on a log entry, highlight the desired log and press **F4** (EXPD INFO). A screen will come up telling the user what advisory is being viewed out of a total number of advisories.

Property or Board/Point

This message shows the location where the advisory was generated. This will be a board and point address or an application input or output (in Area Ctrl:Application:Property) format.

Advisory Message

The advisory message is displayed below the Property or Board/Point. The Advisory Message describes the advisory log entry (what went wrong in the system).

Acknowledge Status

Acknowledge Status describes the state of the advisory. If an advisory has been acknowledged or reset, the user name or the person who acknowledged or reset the alarm will appear below the acknowledge status. The date and time when the advisory was acknowledged or reset will also be displayed below the user's name.

If the advisory has not been acknowledged or reset, this field will display an asterisk "*" along with the word "UNK."

Report Priority

The report priority fields describe the priority level of the advisory, as well as the date and time the advisory occurred.

Return To Normal

If the advisory has returned to a normal state, either on its own or because of a user-ordered alarm reset, the date

and time on which the reset occurred will be shown beside the report priority.

12.10.9 Facility Status Display (FSD) Alarms

The FSD can be used to handle alarms. Information such as time stamp, alarm ID string, current status, the reason an alarm was triggered, (if a case temp limit was exceeded) configured priority of the advisory, Return-To-Normal information, and if available, the limit that was exceeded can be viewed through the FSD. Alarms cannot be configured from the FSD unit.

If more than one E2 controller is at a site, one E2 must be set up as the alarm annunciator for that site. The FSD will receive alarms from that alarm-annunciator E2 for the entire site. The FSD will point only to a single E2 at a site (it will not poll multiple controllers for alarms). For more information, refer to the FSD Manual (*P/N 026-1400*).

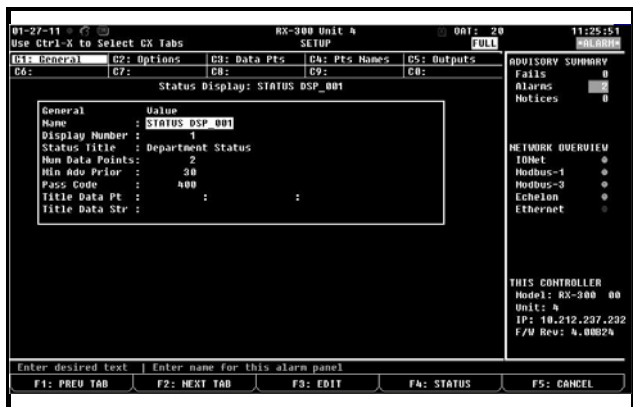

Figure 12-23 - FSD General Setup

12.11 Viewing Logs and Graphs

There are two basic forms used by the E2 to display data: logs and graphs.

A log is simply a list of sampled values for a particular input or output along with the sampling times and dates. When you view logged data in this form, it is usually listed with the most recent sample at the top of the list, and the other samples listed below it in reverse chronological order.

A graph is a graphical representation of these log entries that shows how the sampled value has changed over time. Graphing is a quick, easy way to get an idea of how the application has been behaving. Special graphing features also allow you to zoom in on specific areas of the

graph.

12.11.1 Locating Logged Inputs/Outputs

12.11.1.1 Home/Status Screens

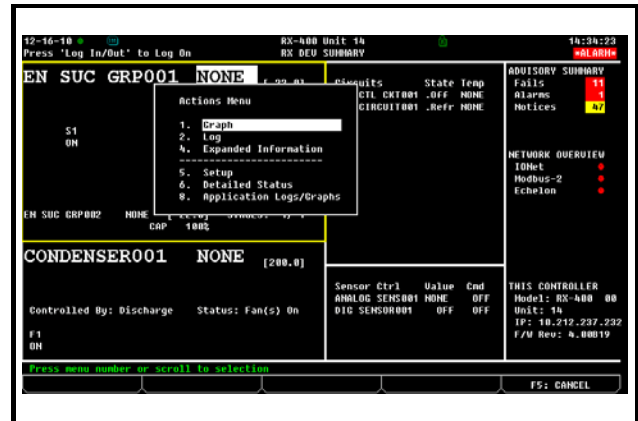

Figure 12-24 - Sample Actions Menu From RX Home Screen

The easiest way to access a log or graph is from the Actions menu while on the Home screen or an application's Status screen. These screens contain a number of different input and output values from the application. If a particular input or output is being logged by the E2 and has log data stored in the system, you can view the log or graph by following the instructions below:

1. Use the arrow keys to highlight the desired input or output on the Home or a Status screen.
2. Press **Enter** to call up the Actions Menu, and select either option **1** to view a graph or **2** to view a log.

If Graph and Log options are not listed in the Actions Menu, this means the property you have selected is not set up to be logged.

It may also be the case that there are currently no logged values to be viewed (this often happens when a controller is first set up or after a log has been cleared). If this is the case, E2 will tell you that no logged samples exist. For a complete list of items in the Actions Menu, refer to **Section 10.7.3, The Actions Menu**.

12.11.1.2 Setup Screens

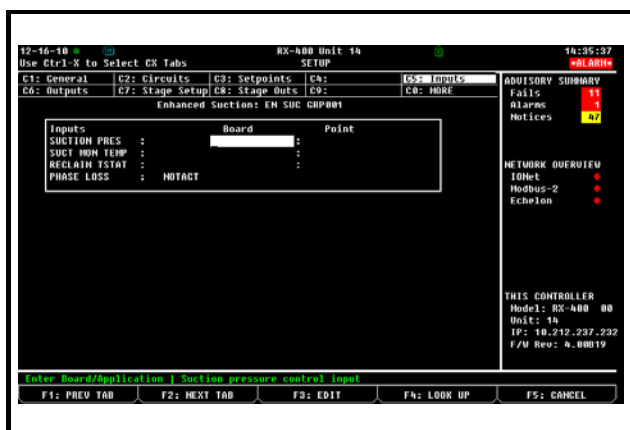

Figure 12-25 - Example Setup Screen (Setpoints)

When setting up an application using a Setup screen (see [Section 10.7.2, Status Screens](#)) all inputs and outputs that are set up to be logged will be marked with an L on the right-hand side. From the Setup screen, you may access the logs of these inputs by pressing **F3**.

12.11.1.3 Setting Up Input and Output Pointers

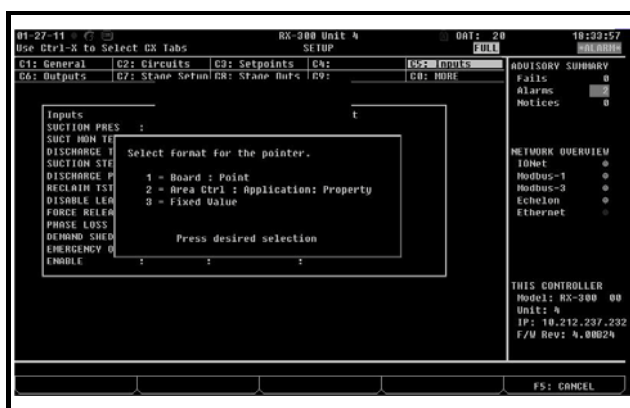

Figure 12-26 - Pointer Format Box

Pointers allow a property to get or send its value to another property, and are a way to transfer information or values (input and outputs) from one application to another within a controller.

For example, if you are setting up a Suction Pressure pointer, you are specifying the location of where the Suction Pressure is coming from. Note that:

- An output pointer can be connected to multiple input pointers
- A single input pointer *cannot* be connected to multiple output pointers
- Pointers can be set up for all applications

To set up pointers from a Setup screen:

1. Press **F5** (SETUP) from the desired application's Status screen. (If starting from the Home screen, move the cursor to the desired application's value and press **Enter** to open the Actions Menu. Choose **Setup**. This will take you to the Setup screen.)
2. Once inside the application's Setup screen, use the **F1** and **F2** keys to highlight the **Inputs** and **Outputs** index tabs.
3. Press **F3** (EDIT) to open the Edit menu.
4. Choose **Alternate I/O Formats** to open the format menu.
5. Choose one of the pointer formats.

If you are in the **Inputs** setup and have selected **Area Ctrl: Application: Property** as the pointer format, the third column (the **Output** field) is the output that you are pointing (connecting) the input to. If you are in the **Outputs** setup and have selected **Area Ctrl: Application: Property** as the pointer format, the third column (the **Input** field) is the input that you are pointing (connecting) the output to.

Changing the format to a **Fixed Value** will give you the option of entering a value in the field that will be read by the input instead of being hooked to a board:point or another cell.

For information on naming conventions for E2 controllers, applications, and points, see [Section 12.12, Naming Conventions for E2 Controllers, Applications, and Points](#).

12.11.2 Log View

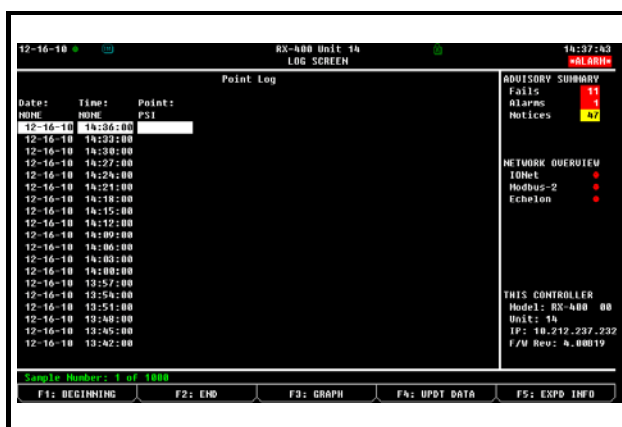



Figure 12-27 - Sample Log View



The Log view shows logged data in a tabular format arranged by the date/time of sample.

1. Highlight a value from any screen and press

 to open the Actions Menu.

2. Select **Log**, and the Log screen opens.

Several function keys may be used to navigate the Log view and provide additional information:

- **F1** BEGINNING - Move the cursor to the top of the table (the most recently recorded sample).
- **F2** END - Move the cursor to the bottom of the table (the oldest sample).
- **F3** GRAPH - Displays logged data in a graph format (see *Sample Graph View Figure 12-28*).
- **F4** UPDT DATA - Pressing this key updates the Log View by adding all newly recorded samples to the top of the table.
- **F5** EXPD INFO - Pressing this key will display the board/point address or the controller/application/property address for the point that is being logged.
-  Page Up - Scrolls up one page.
-  Page Down - Scrolls down one page.

12.11.3 The Graph View

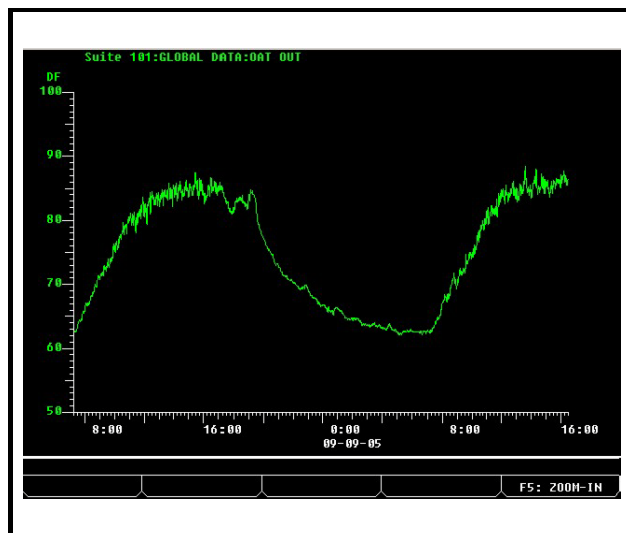



Figure 12-28 - Sample Graph View

The Graph view shows logged data in a graphical format with sample times as the X (horizontal) coordinate and sample values as the Y (vertical) coordinate. To access a graph view:

1. Highlight a value from any screen and press  to open the Actions Menu.
2. Select **Graph**, and a graphed view of the selected value opens.

Upon first entering the Graph view for a logged value, all available samples are displayed. The X axis (sample time) ranges from the time and date of the earliest available sample relative to the time and date of the latest sample. The Y axis (sample value) ranges from the minimum sensor reading to the maximum sensor reading.

In the case of an input point log, (e.g., suction pressure) assume the Log Group setup specifies Samples as 1000 and Log Interval as 0:03:00. Also assume that the system has been running continuously with no interruptions for one week. The X axis would span a time interval starting approximately six days and six hours ago all the way up to the present.

If suction pressure ranged from 18 psi to 25 psi during the time period of the log, the Y axis of the graph would be just large enough to show all samples in the log.

12.11.4 Zooming In and Out

For a more detailed view of a graph, zoom in by pressing **F5**. This results in half of the samples of the current view being redrawn to fill the entire view. Using the above example, the graph would now show three days and three hours of samples from the middle of the original graph.

Pressing **F5** again zooms in even farther.

Pressing **F4** zooms out, resulting in a graph whose time scale spans twice that of the previous view. This doubles the number of displayed samples.

Navigating a Zoomed View

While zoomed in on a graph, only a subset of the total number of samples are visible. To view samples that were recorded earlier or later than those in the current view, press the left and right cursor keys. The availability of earlier or later samples is indicated by the presence of arrows at either end of the X (time) axis.

12.12 Naming Conventions for E2 Controllers, Applications, and Points

- Do not name applications, controllers, or points with all numeric characters.
- Do not use colons (:) in the names of applications, controllers, or points.

Appendix A: Case Type Defaults

The table below lists the sixty-four default case types that may be used in Standard Circuit or Case Control Circuit applications along with the recommended defaults for each case type.

When one of these sixty-four case types is selected, the E2 automatically enters the following information from the table into the Circuit application:

- The setpoint
- The number of defrosts per day and the defrost time length from the “Elec” column under Defrost types

For example, if you select #14 “RIFF” (reach-in frozen food), the E2 sets the circuit’s setpoint at -10, the number of defrosts at 1, and the defrost time at 60 minutes.

The other columns in this table, such as the High and Low Alarm/Dly columns and the Hot Gas, Rev. Air, and Timed columns, are suggested values that are not automatically entered into the Circuit application.

High Alarm, Low Alarm, and Delay

The High Alarm, Low Alarm, and Delay columns are the suggested high and low case temperature alarm setpoints and the report delay. To set up these alarm setpoints and delays, locate the Case Temperature control input and select the Generic Alarm Setup action from the Actions Menu. Enter the High and Low setpoints in the Normal Hi and Normal Low fields respectively. Enter the Delay in the Report Delay field.

Defrost Type

The E2 assumes by default that all cases have electric defrost. If this is not the case, you will have to enter new values for the Number of Defrosts and the Defrost Time in the circuit. The suggested defaults are listed under the Hot Gas, Elec, Rev. Air, and Timed columns. The number to the left of the slash indicates the suggested number of defrost times per day, and the number to the right of the slash indicates the recommended Defrost Time length.

Type	Abbr.	Description	Set-Point	High Alarm	Low Alarm	Delay	Defrost Type			
							Hot Gas	Elec. (DEF)	Rev. Air	Timed
0	****	Undefined								
1	SDIC	Single deck ice cream	-25	-5°	-30°	01:00	2/18	1/45	1/60	1/60
2	MDIC	Multi-deck ice cream	-25	-5°	-30°	01:00	3/22	3/45	2/60	2/60
3	SDFJ	Single deck freezer juice	-18	0°	-30°	01:00	2/18	1/45	1/60	1/60
4	MDFJ	Multi-deck freezer juice	-10	5°	-25°	01:00	3/22	3/45	2/60	2/60
5	RIIC	Reach-in ice cream	-15	-5°	-25°	01:00	2/22	1/45	1/60	1/60
6	ICBX	Ice cream freezer box	-20	-5°	-30°	01:00	3/20	2/45	2/60	2/60
7	SDFJ	Single deck freezer food	-15	5°	-25°	01:00	2/18	1/60	1/60	1/60
8	RIFF	Reach-in freezer juice	-15	-5°	-20°	00:15	2/22	1/45	1/60	1/60
9	FRBX	Frozen food box	-12	-5°	-20°	00:15	3/18	3/45	2/60	2/60
10	FFBX	Frozen fish box	-12	-5°	-20°	00:15	3/18	3/45	2/60	2/60
11	FJBX	Frozen juice box	-12	-5°	-25°	01:00	3/18	3/45	2/60	2/60
12	MDFJ	Multi-deck freezer food	-10	0°	-20°	01:00	2/22	1/45	2/60	2/60
13	FZBK	Multi-deck freezer bakery	-10	0°	-20°	01:00	2/22	1/45	2/60	2/60
14	RIFF	Reach-in freezer food	-10	5°	-15°	01:00	1/20	1/60	1/60	1/60
15	SDMT	Single deck meat	22	32°	12°	01:00	3/18	3/45	3/60	3/60
16	SDPF	Single deck prepared	22	32°	12°	01:00	3/18	3/45	3/60	3/60
17	PZZA	Single deck pizza	22	32°	12°	01:00	3/18	3/45	3/60	3/60
18	KOSH	Single deck kosher	22	32°	12°	01:00	3/18	3/45	3/60	3/60
19	SDFH	Single deck fish	22	32°	12°	01:00	3/18	3/45	3/60	3/60
20	MDMT	Multi-deck meat	23	34°	18°	01:00	4/18	4/45	4/60	4/60
21	MDPO	Multi-deck poultry	23	34°	18°	01:00	4/18	4/45	4/60	4/60
22	MDFH	Multi-deck fish	23	34°	18°	01:00	4/18	4/45	4/60	4/60
23	RIMC	Reach-in meat	25	35°	15°	01:00	2/18	2/45	2/60	2/60
24	SVMT	Service meat	22	35°	15°	01:00	2/18	2/45	2/60	2/60
25	SVFH	Service fish	22	35°	15°	01:00	2/18	2/45	2/60	2/60
26	MTBX	Meat cooler	30	42°	22°	01:00	3/18	3/45	2/60	2/60

Table A-1 - Case Type Default Settings



Type	Abbr.	Description	Set-Point	High Alarm	Low Alarm	Delay	Defrost Type			
							Hot Gas	Elec. (DEF)	Rev. Air	Timed
27	HDBX	Meat holding box	30	44°	22°	01:00	3/18	3/45	2/60	2/60
28	DYCS	Multi-deck dairy	35	44°	24°	01:00	4/20	4/45	2/60	4/60
29	RFDY	Rear load dairy	28	38°	18°	01:00	4/20	4/45	2/60	4/45
30	RIDY	Reach-in dairy	30	40°	20°	01:00	4/20	4/45	2/60	2/60
31	DYBX	Dairy cooler	34	44°	24°	01:00	2/22	2/45	2/60	2/60
32	BKBX	Bakery Cooler	36	46°	26°	01:00	2/22	2/45	2/60	2/60
33	PRBX	Produce cooler box	36	50°	30°	01:00	2/22	2/45	2/60	2/60
34	MILK	Milk case	34	40°	20°	01:00	4/20	4/45	2/60	2/60
35	PKDL	Packaged deli	32	38°	18°	01:00	4/20	4/45	2/60	2/60
36	DLDS	Deli display case	34	38°	18°	01:00	4/20	4/45	2/60	2/60
37	CHEZ	Cheese case	34	40°	20°	01:00	3/18	3/45	2/45	2/60
38	POBX	Poultry box	36	42°	22°	01:00	4/20	4/45	2/45	2/60
39	BEER	Beer/Beverage	34	44°	24°	01:00	2/18	2/45	2/45	2/60
40	BVCS	Beverage case	34	44°	24°	01:00	2/18	2/45	2/45	2/60
41	DLBX	Deli cooler box	36	46°	26°	01:00	3/18	3/45	2/45	2/60
42	FHBX	Fish cooler box	36	46°	26°	01:00	3/18	3/45	2/45	2/60
43	SVDL	Service deli	32	42°	22°	01:00	2/16	2/45	2/60	1/40
44	PRCS	Produce case	35	45°	25°	01:00	2/16	2/45	2/60	3/40
45	ISPR	Produce case (island)	35	45°	25°	01:00	2/16	2/45	2/60	1/60
46	SALD	Salad table	36	50°	30°	01:00	2/16	2/45	2/60	1/60
47	FLBX	Flower cooler box	40	54°	34°	01:00	2/16	2/45	2/60	2/40
48	FLWR	Flower cooler	40	54°	34°	01:00	2/16	2/45	2/60	2/40
49	CTBX	Controlled temp box	50	75°	40°	00:15	2/16	2/45	2/60	2/45
50	SDPO	Single deck poultry	24	38°	18°	01:00	2/16	2/45	2/45	2/60
51	CAKE	Bakery cake case	40	55°	35°	01:00	2/16	2/45	2/45	2/60
52	BART	Bakery retarder	35	60°	40°	01:00	2/16	2/45	2/45	2/60
53	RTDR	Bakery retarder	35	60°	40°	01:00	2/16	2/45	2/45	2/60
54	MTPK	Meat packaging room	45	60°	40°	01:00	2/16	2/45	2/45	2/90
55	MTCU	Meat cutting room	45	60°	40°	01:00	2/16	2/45	2/45	2/90
56	MTPR	Meat prep room	45	60°	40°	01:00	2/16	2/45	2/45	2/90
57	MTWR	Meat wrapping room	45	60°	40°	01:00	2/16	2/45	2/45	2/90
58	FHPR	Fish prep room	45	60°	40°	01:00	2/16	2/45	2/45	2/90
59	SBCL	Subcooler	55	60°	45°	00:15	2/16	2/45	2/60	2/45
60	PRPR	Produce prep room	55	65°	45°	01:00	2/16	2/45	2/45	2/90
61	SDFM	Single deck freezer meat	-10	0°	-20°	01:00	2/18	2/40	1/35	1/45
62	RIFM	Reach-in freezer meat	-10	2°	-18°	01:00	2/18	2/40	1/35	1/45
63	MDFM	Multi-deck freezer meat	-10	0°	-20°	01:00	2/18	2/40	2/60	2/45
64	BKFZ	Bakery freezer box	-12	-2°	-22°	01:00	2/18	2/30	2/60	2/45

Table A-1 - Case Type Default Settings

Appendix B: Pressure/Voltage and Temperature/Resistance Charts for Eclipse Transducers & Retail Solutions Temp Sensors

Retail Solutions Temperature Sensors	
Resistance (ohms)	Temperature (F)
336,450	-40
234,170	-30
165,210	-20
118,060	-10
85,399	0
62,493	10
46,235	20
34,565	30
26,100	40
19,899	50
15,311	60
11,883	70
9,299	80
7,334	90

Table B-1 - Temp Sensor Temperature/Resistance Chart

Eclipse Transducers			
Voltage (VDC)	Pressure (PSI)		
	100 lb. xducer	200 lb. xducer	500 lb. xducer
0.5	0	0	0
0.7	5	10	25
0.9	10	20	50
1.1	15	30	75
1.3	20	40	100
1.5	25	50	125
1.7	30	60	150
1.9	35	70	175
2.1	40	80	200
2.3	45	90	225
2.5	50	100	250
2.7	55	110	275
2.9	60	120	300
3.1	65	130	325
3.3	70	140	350
3.5	75	150	375
3.7	80	160	400
3.9	85	170	425
4.1	90	180	450
4.3	95	190	475
4.5	100	200	500

Table B-2 - Eclipse Voltage to Pressure Chart

Appendix C: Alarm Advisory Messages

The table below is a list of all alarm messages that may appear in E2's Alarm Advisory Log. Each alarm message is listed by its Alarm Name, which is the text recorded in the Alarm Advisory Log when the error occurs, and the Default Priority, which is the default priority value for the alarm. A Default Priority of "User" indicates the alarm type's priority is programmed by the user during application setup.

Alarm Name	Default Priority	Definition
# Of Events Exceeded Limit	User	A digital value has transitioned ON more times than its defined Number of Events setpoint.
50/60 Hz Line Clock Is Bad	20	E2 is not successfully synchronizing its clock with the 50/60 Hz pulse of its incoming power.
A FreezeStat Input Is Too Low	User	A temperature sensor on an HVAC cooling stage is lower than the programmed freezestat setpoint, indicating possible coil freeze.
Access Log Lost - CRC Error	20	An internal error has caused the loss of E2's user access log.
Advisory Log Lost - CRC Error	20	An internal error has caused the loss of E2's alarm advisory log.
Alarm Limit Exceeded	User	An Analog Sensor or a Suction Group has an input value greater than one of its high limit setpoints.
Alarm(s) Were Cleared	99	A user has erased one or more alarms from the alarm advisory log.
Alarm(s) Were Reset	99	A user has reset one or more alarms from the alarm advisory log.
All Config/Logs Were Cleared	30	A user has performed a clean out on this E2, removing all programming and stored data.
All Lights On	User	A Global Data application's All Lights On input has turned ON to switch on all the lights.
All network connections used	50	Echelon controller has reached its limit of bound NVs
Alternate Hi Limit Exceeded	User	An analog value in an application using "alternate" setpoints has risen above its programmed Hi Limit setpoint.
Alternate Low Limit Exceeded	User	An analog value in an application using "alternate" setpoints has risen above its programmed Lo Limit setpoint.
Appl Not Keeping Setpoint	User	An Air Handling Unit or Heat/Cool Heat/Cool application has not achieved setpoint for a prolonged period of time.
Application Cell Is Lost	15	An internal error has caused the loss of an entire application cell.
Application Config Has Changed	99	A user has changed the configuration of one of E2 applications.



Alarm Name	Default Priority	Definition
Application Setpoint Has Changed	99	A user has changed a setpoint in one of E2's applications.
Application Was Created	99	A user has created a new application in this E2.
Application Was Deleted	99	A user has deleted an existing application in this E2.
ARTC/MultiFlex RTU Override Switch Stuck	20	An override switch on an ARTC/ MultiFlex RTU has been ON for a prolonged period of time, suggesting a possible switch failure.
ARTC/MultiFlex RTU Reset From Power Failure	50	An ARTC/MultiFlex RTU lost power and reset when power was restored.
Attempt To Write Past Mem. EOB	50	The E2 attempted to write data to memory, but the memory was full.
Average Log Stuck-No Memory	15	The Average Log cannot be written because there is not enough memory.
Bad Modem	20	The modem on this E2 is not functioning properly.
Battery backed memory lost	30	Battery backed memory loss not due to cleanout.
Batt Runtime Limit	99	Battery runtime has exceeded 80% of the battery lifetime.
Binding Input To Output Failed	20	A valid connection could not be made between an input and an output.
BIOS/BIOS Ext. Update Failed	20	An update to the E2's BIOS has failed.
BIOS/BIOS Extension Updated	50	The E2's BIOS was successfully updated.
Can't Set Hardware Clock	20	The E2 is unable to change the time on its hardware clock.
Case Cleaning Was Started	User	A case circuit has entered clean mode.
Case Temp Hi Limit Exceeded	User	A single temperature sensor in a Standard Circuit or Case Control Circuit is recording a temperature higher than its defined case temperature high setpoint.
Case Temp Low Limit Exceeded	User	A single temperature sensor in a Standard Circuit or Case Control Circuit is recording a temperature lower than its defined case temperature low setpoint.
Cell Config Not Restored	15	E2's attempt to restore configuration data to its applications has failed.
Cell Create Failed For Restore	20	E2 attempted to create new applications as part of the configuration restoration process and failed to do so successfully.
Checkit Sensor Has Failed	User	A Checkit sensor is returning an invalid temperature value, indicating a sensor failure.
Checkit Sensor Is Alarming	User	A Checkit sensor on a Suction Group application is recording a high temperature.
Checkit Sensor Is In Notice	User	A Checkit sensor's temperature is above its programmed notice setpoint.

Alarm Name	Default Priority	Definition
Comb Temp Hi Limit Exceeded	User	The combined temperature of an entire Standard Circuit or Case Control Circuit has risen above its programmed high temperature setpoint.
Comb Temp Low Limit Exceeded	User	The combined temperature of an entire Standard Circuit or Case Control Circuit has fallen below its programmed low temperature setpoint.
Commission failed-chk network	50	Commission of Echelon controller failed; binding of NV was not successful. Check the Echelon network.
Communication Port 1 Is Down	20	E2 cannot communicate with the RS232 port on the E2 main board. The E2 main board likely needs repair or replacement.
Communication Port 2 Is Down	20	E2 cannot communicate with the RS485 network port on the E2 main board. The E2 main board likely needs repair or replacement.
Communication Port 3 Is Down	20	E2 cannot communicate with the modem slot on the E2. The E2 main board likely needs repair or replacement.
Communication Port 4 Is Down	20	COM4 is used by service personnel to attach hardware used in test or debug functions. This alarm indicates the port that allows E2 to communicate with these devices is faulty. The E2 board likely needs repair or replacement.
Communication Port 6 is down	20	E2 cannot communicate with port 6 on the E2 main board.
Completed Firmware Update	50	The E2's firmware was successfully updated.
Config Loss - Chg In Tmpl Rev.	15	Due to a difference between configuration templates in a previous E2 version and templates in the current version, configuration data could not be restored.
Config Loss-CRC Error	15	Due to an internal error, E2 has lost configuration data.
Config Loss-File CRC Error	15	Due to an internal error, E2 has lost configuration data.
Config Not Saved To Flash	20	E2 could not save configuration data to flash memory.
Controller (or Device) Absent From Network	20	The current E2 could not find the specified E2, I/O board, or Echelon controller
Controller Reset	50	An ARTC/MultiFlex RTU has gone through a reset.
Controller Shutdown	50	The E2 has gone through a shutdown.
Controller Startup	50	The E2 has re-started after a shutdown.



Alarm Name	Default Priority	Definition
Controller Type Mismatch	20	A device on the Echelon network is of a different type than the user has specified. In other words, a user might have wired a device such as a CC-100P to the network but set it up in the E2 software as a CC-100LS. Check your network setup and if necessary reconfigure the device with the correct type.
Controller Was Warm-booted	50	A user has reset the E2 using the “reset” button on the main board.
Couldn't Get File Handle	20	E2 tried to get a file from its memory and failed to do so. This alarm likely indicates one or more templates in the E2 software have been corrupted. Contact Retail Solutions service for further assistance.
Curtail On	User	A Curtailment device set up in Global Data has activated to begin curtail.
DFMC Standby Mode	20	A DFMC is put into standby by a service technician; it indicates the unit is not actually controlling.
DFMC Check Clock Settings	99	Sent by the DFMC when it has lost its internal time-of-day, E2 will resend the time upon receipt and this alarm should return-to-normal without user interaction.
DFMC Over Max Defrost	20	A defrost duration was in excess of the maximum limit defined. For example, the case is not defrosting within spec.
DFMC Over Max Fan Delay	30	Maximum fan delay time has been exceeded.
DFMC Inject Alarm	30	Related to the case's ability to get refrigerant into the coil. For example, this alarm may occur if the case is not being supplied with the proper temperature refrigerant.
DFMC Door Alarm	99	Door to a case has been left open too long.
Defrost terminated on Time	30	EC2, EC3
Defrost terminated on Temp.	30	EC2, EC3
Dest. Mem. Not Allocated Block	50	An internal error has occurred in the E2.
Dest. Mem. Out Of Stack Bounds	50	An internal error has occurred in the E2.
Device Absent From Network	20	The current E2 could not find the specified E2, I/O board, or Echelon controller
Diagnostic Rate Change Failed	20	A user tried to change the update rate of a CC-100, RT-100, or similar Echelon device, but the change was not accepted. Try the update rate change again. If this alarm persists, call Retail Solutions service.
Dial To Day Time Site 1 Failed	20	E2 tried to dial out to the site listed as Day Time Site 1 and was unsuccessful.
Dial To Day Time Site 2 Failed	20	E2 tried to dial out to the site listed as Day Time Site 2 and was unsuccessful.

Alarm Name	Default Priority	Definition
Dial To Day Time Site 3 Failed	20	E2 tried to dial out to the site listed as Day Time Site 3 and was unsuccessful.
Dial To Night Site 1 Failed	20	E2 tried to dial out to the site listed as Night Site 1 and was unsuccessful.
Dial To Night Site 2 Failed	20	E2 tried to dial out to the site listed as Night Site 2 and was unsuccessful.
Dial To Night Site 3 Failed	20	E2 tried to dial out to the site listed as Night Site 3 and was unsuccessful.
Did Not Defrost	User	A case circuit did not enter defrost at its scheduled time.
Did Not Exit Defrost	User	A CC-100 or CS-100 that entered defrost did not terminate or exit defrost at its programmed time.
Did Not Exit Wait	User	A CC-100 or CS-100 terminated defrost and entered the WAIT state, but did not exit the WAIT state when refrigeration re-started.
Did Not Exit Wash	User	A CC-100 or CS-100 did not exit Clean Mode.
Did Not Respond To command	User	A CC-100 or CS-100 did not respond to an E2 command.
Did Not Terminate Defrost	User	Defrost in a standard circuit lasted for its entire programmed time duration and did not terminate. Usually this means the termination sensor did not record a temperature higher than its setpoint, but it could also mean sensor failure has occurred.
Did Not Wash	User	A case circuit that was ordered to go into cleaning mode did not successfully enter Clean Mode.
Differential Limit Exceeded	User	The difference between the supply air temperature and the return air temperature in an HVAC application was less than the programmed heating or cooling differential setpoint. This might indicate a problem with cooling or heating.
Dirty Filter Detected	30	A filter-checking device connected to an ARTC/ MultiFlex RTU is detecting a dirty filter.
Discharge Trip	User	A high discharge pressure detected by a Suction Group application has caused an emergency shut-down of the compressor rack.
Door Open	30	EC2, EC3
Duplicate Controller Names	20	Two controllers on the network have the same names. One of them will need to be renamed to prevent communications problems.
Events Per Hour Exceeded Limit	User	A digital value has transitioned ON more times in the past hour than its defined Events Per Hour setpoint.



Alarm Name	Default Priority	Definition
External Fault	30	An external fault input defined in a Multiflex PAK controller has indicated a failure. External fault inputs in the PAK are used to detect a Rack (Pack) failure produced by some device out of the PAK's control.
Failed Attempt To Bind Input	50	A valid link could not be made between an E2 application and an input assigned to it.
Failed Sensor Or Bad Wiring	20	E2 is unable to get a valid sensor value due to a possible hardware problem.
Failed To Create logging	20	E2 is unable to create logs for the input or output shown.
Failed to Obtain DHCP Lease	20	Failed to obtain a DHCP lease from the DHCP Server, when a lease is requested. This happens at system startup, if a DHCP lease is requested, or if the user switches to using DHCP.
Failed to Renew DHCP Lease	20	DHCP Lease failed to renew altogether. DHCP Leases are renewed at an interval of half the time of the requested lease. If the lease is for 5 days, then a renewal will happen at 2.5 days. If this fails, it will retry at the $\frac{3}{4}$ of the lease time. If both attempts fail, the alarm is generated.
Fax Init String Is Not Valid	30	The fax initialization string for the E2's modem is incorrect and may need editing.
Features denied during restore	99	License manager has denied permission to access a feature during a restore. Either the license for that feature is invalid or it does not exist, or the number of licenses for that feature is less than the number needed for the configuration. Further information may be found in the service log.
Features denied during startup	99	License manager denied permission to access a feature during startup. Either the license for that feature is invalid or it does not exist, or the number of licenses for that feature is less than the number needed for the configuration. Further information may be found in the service log.
File Not Found	50	An internal error has occurred in the E2.
Firmware File Bad - AI200	15	A 16Aie has corrupted firmware.
Firmware File Bad - RO200	15	An 8ROe has corrupted firmware.
Firmware File Bad - CC100 Liq	15	A CC-100P or CC-100LS has corrupted firmware.
Firmware File Bad - CC100 Suct	15	A CC-100H has corrupted firmware.
Firmware File Bad - CS100 Ckt	15	A CS-100 has corrupted firmware.
Firmware File Bad - ESR8	15	An ESR8 has corrupted firmware.
Firmware File Bad - RT100	15	An RT-100 has corrupted firmware.

Alarm Name	Default Priority	Definition
Firmware Is Not Compatible	20	The firmware in a unit controller is not compatible with the current version of E2.
Firmware Update Failed	10	The firmware on a unit controller was not successfully updated.
Flash File Has A Bad CRC Error	50	An internal error has occurred in the E2.
Flow obstructed	30	Irrigation pipe obstruction detected.
Fuse Is Blown - ESR8	20	A fuse has blown on an ESR8 board and will require replacement.
Global Spare Dig1 On	User	The Spare Dig 1 input in Global Data has switched ON.
Gradual Change Limit Exceeded	User	An analog value has undergone a gradual change greater than its programmed Minimum Change set-point.
Heap Memory Corrupted - Reboot	30	A problem with memory has resulted in a reset of the E2.
High Discharge Limit Exceeded	User	A high discharge pressure detected by a Suction Group application is causing the suction group to operate at a reduced capacity.
High Limit Alarm	User	An HVAC application (AHU, Zone, RT-100, or ARTC/MultiFlex RTU) has a temperature above one of its cooling setpoints.
High Limit Notice	50	Network variable high limit exceeded.
High Suction Limit Exceeded	User	The suction pressure has risen above a Suction Group's high suction setpoint.
HVAC Phase Loss	User	A phase loss device connected to Global Data has switched ON to shut down all HVAC systems.
HVAC Shutdown	User	A Global Data application's HVAC Shutdown input has turned ON to shut down all HVAC systems.
Incomplete Advisory Setup	15, 99	An important setting used in advisory and/or dial-out set up were not configured correctly.
Inhibit Sensor Failed	User	A Demand Defrost Inhibit sensor on a case circuit is not functioning correctly.
Input Bypass Failure	15	A command to bypass an input was not successfully carried out.
Input Sensor Is Open	20	An analog input sensor is OPEN, possibly due to a severed connection or sensor failure.
Input Sensor Is Short	20	An analog input sensor is CLOSED, possibly due to a short-circuit or sensor failure.
Instance limit exceeded	20	Maximum number of a particular type of licensed Open Echelon controllers has been reached. A new instance cannot be commissioned.
Invalid Cell ID In Scratch Pad	30	An internal error has occurred in the E2.
Invalid Nxt Ptr In Scratch Pad	30	An internal error has occurred in the E2.
Invalid Scratch Pad Block Size	30	An internal error has occurred in the E2.



Alarm Name	Default Priority	Definition
IRLDS: Absorption Data Error	20	An internal error has occurred in the IRLDS. Check the IRLDS display for error code information, and call Retail Solutions service.
IRLDS: ADC Error	20	An internal error has occurred in the IRLDS. Check the IRLDS display for error code information, and call Retail Solutions service.
IRLDS: Data Error	20	An internal error has occurred in the IRLDS. Check the IRLDS display for error code information, and call Retail Solutions service.
IRLDS: Detector Data Error	20	An internal error has occurred in the IRLDS. Check the IRLDS display for error code information, and call Retail Solutions service.
IRLDS: Drift Fault	20	An internal error has occurred in the IRLDS. Check the IRLDS display for error code information, and call Retail Solutions service.
IRLDS: General Fault	20	An internal error has occurred in the IRLDS. Check the IRLDS display for error code information, and call Retail Solutions service.
IRLDS: Line/Filter Flow Fault	20	A zone on an IRLDS unit has a dirty filter or a crimped tube.
IRLDS: Pressure Data Error	20	An internal error has occurred in the IRLDS. Check the IRLDS display for error code information, and call Retail Solutions service.
IRLDS: Self-Test Failure	20	An IRLDS has failed its self-test procedure.
IRLDS: Temperature Data Error	20	An internal error has occurred in the IRLDS. Check the IRLDS display for error code information, and call Retail Solutions service.
IRLDS: Unknown Error	20	The IRLDS has experienced an error not recognized by the E2.
IRLDS: Voltage Data Error	20	An internal error has occurred in the IRLDS. Check the IRLDS display for error code information, and call Retail Solutions service.
ISD Missing Phase Lockout	20	After 10 consecutive missing phase trips, the compressor is locked out on missing phase lockout.
ISD Missing Phase Trip	99	If any of the 3 phases of power is missing after the compressor is called to be on, this advisory is generated.
ISD Oil Pressure Lockout	20	If we have been in Low Oil warning for 2 minutes we will lock out the compressor.
ISD Welded Contactor	20	If there is voltage on the 3 phase sense inputs 0.5 seconds after the compressor is called to be off, this advisory is generated.
ISD Compressor Module Failure	20	A hardware failure has occurred in the ISD module.

Alarm Name	Default Priority	Definition
ISD Discharge Pressure Lockout	20	The discharge pressure has gone above the high discharge cut out, and this condition is set to only generate a lock out.
ISD Discharge Temp Lockout	20	A lock out has occurred on the compressor because the discharge temperature sensor has gone above its alarm set point.
ISD Supply Voltage Trip	99	If the supply voltage to the ISD falls below 170V, this advisory is generated.
ISD Motor Temp Trip	99	The motor winding temperature sensor has gone above their preset value on compressors equipped with them.
ISD Low Oil Warning	99	Low oil pressure is sensed on starting the compressor.
ISD Internal Line Break	99	The internal line breaks have opened on compressors equipped with them.
ISD Discharge Pressure Trip	99	The discharge pressure has gone above the high discharge cut out, and this condition is set to only generate a trip.
ISD Discharge Temp Trip	99	A trip has occurred on the compressor because the discharge temperature sensor has gone above its alarm setpoint.
ISD Suction Pressure Trip	99	The suction pressure has fallen below the low pressure cut out.
ISD No 3 Phase On Start	99	If there is no 3 phase power on the 3 phase sense inputs when the compressor is called to be on.
ISD No Command Communications	99	The ISD will only accept run commands from the Einstein when the communications jumper is installed. If this jumper is not installed, an advisory will be generated.
KW Demand Limit Exceeded	User	The power measurement taken by a Power Monitoring or Demand Control application is higher than the programmed demand setpoint.
Link To Output Bad-No Output	50	A valid link could not be made between an E2 application and an output assigned to it.
Last Off Time Expired	99	Notice or alarm generated in digital generic alarming.
Last On Time Expired	99	Notice or alarm generated in digital generic alarming.
Leak detected	30	Irrigation pipe leak detected.
Log Data Loss-SRAM Data Bad	50	A memory error has resulted in lost log data.
Log Stamp Loss-Flash Data Bad	50	A memory error has resulted in lost log time stamp data.
Log Stamp Loss-SRAM Data Bad	50	A memory error has resulted in lost log time stamp data.
Logging Group Stuck-No Memory	15	A Logging Group is unable to save logging data because there is not enough memory.



Alarm Name	Default Priority	Definition
Lost Log Data-CRC Error	30	An internal error has occurred in E2, resulting in lost log data.
Low Battery Voltage	99	The backup battery that keeps the time and date resident on the E2 main board may need to be replaced.
Low Limit Alarm	User	An HVAC application (AHU, Zone, RT-100, or ARTC/MultiFlex RTU) has a temperature below one of its heating setpoints.
Low Limit Notice	50	Network variable low limit exceeded.
Low Pack Superheat	11	Multiflex Pak ProAct superheat low limit exceeded.
Low Suction Limit Exceeded	User	The suction pressure has fallen below a Suction Group's low suction setpoint.
MIP Receive Buffer Overflow	20	Messages from the Echelon network are coming into E2 too fast for the controller to process. This might be caused by an E2 having too many applications and/or logs running, or there may be too many Echelon devices on the same segment as the E2 (i.e., more than 63). If this message persists, call Retail Solutions service.
Modem Didn't Initialize	20	E2 attempted to initialize the modem but failed.
Modem Init String Is Not Valid	30	The dial-out initialization string for the E2's modem is incorrect and may need editing.
Neuron Not Responding	20	The chip that handles Echelon networking on the E2 is either defective or in a mode that makes it non-responsive. Contact Retail Solutions service for assistance.
No Configuration Template	15	There is an internal error in the E2 software. Notify Retail Solutions service.
No Description File	20	The Description File has failed to load onto the E2 when the Echelon device was commissioned. No description file exists for the Open Echelon controller being commissioned.
No Refrigerant flowing	Varies depending on application type	Low or no refrigerant flowing.
No update has been received	Varies depending on application type	No update has been received from the output point connected to.
Normal Hi Limit Exceeded	User	An analog value has risen above its programmed Hi Limit setpoint.

Alarm Name	Default Priority	Definition
Normal Low Limit Exceeded	User	An analog value has fallen below its programmed Lo Limit setpoint.
Not Enough Backed Memory	10	The E2 tried to save data to the battery-backed memory, but the memory was full.
Not Enough Flash Memory	20	The E2 tried to save data to the flash memory, but the memory was full.
Not Enough Memory	10	The E2 tried to save data to unbacked memory, but the memory was full.
Not Enough Scratch Pad Memory	50	The E2 tried to save data to the scratch pad memory, but the memory was full.
Notice Limit Exceeded	User	An analog sensor's programmed notice limit has been exceeded.
Num. Of Events Exceeded Limit	User	A digital value has transitioned ON more times than its defined Number of Events setpoint.
Occupied Hi Limit Exceeded	User	An analog value has risen above its defined high limit setpoint during OCCUPIED mode.
Occupied Low Limit Exceeded	User	An analog value has fallen below its defined low limit setpoint during the OCCUPIED mode.
Off Time Exceeded Limit	User	A digital value has been OFF longer than its defined Time Off Last setpoint.
Oil Failure Occurred	User	An oil sensor for a compressor has detected a failure.
On Time Exceeded Limit	User	A digital value has been ON longer than its defined Time On Last setpoint.
Open Wire	30	MultiFlex ESR controller has detected an open wire on the valve input.
Overcurrent	30	MultiFlex ESR controller has detected an overcurrent condition on the valve.
Override Log lost - CRC Error	20	An internal error in the E2 has resulted in a loss of the override log.
Override Lost Output Cleared	20	A user tried to override an output on a CC-100, RT-100, or similar Echelon device, but the override was not performed successfully. Try the override command again. If this alarm persists, call Retail Solutions service.
Override Operation Didn't Take	20	The E2 tried to carry out an override and was unsuccessful.
Override State Not Restored	50	An overridden input or output has remained in the override state longer than its programmed time.
Pad Memory Corrupted - Reboot	30	A problem with memory has resulted in a reset of the E2.
Part Cnfg Loss-Ptr	15	Due to an internal error, part of E2's configuration data has been lost.



Alarm Name	Default Priority	Definition
Point Log Cleared-Stamps Ahead	50	After a power failure or reset, E2 tried to recover log data from its memory, but the log data was corrupted. E2 cleared all data from its point logs and started over.
Point Log Stuck-No Memory	15	A Point Log is unable to save new values because there is not enough memory.
Point Logs Not Restored	15	The point logs stored in memory were not restored after the last reset or upgrade.
Pressure Table Lost-Being Rblt	50	A Suction Group's internal list of possible compressor combinations became temporarily invalid, requiring a rebuild.
Product Temp Hi Limit Exceeded	User	A product temperature probe in a standard or case-controlled circuit has measured a product temperature above the low limit setpoint.
Product Temp Lo Limit Exceeded	User	A product temperature probe in a standard or case-controlled circuit has measured a product temperature below the low limit setpoint.
Program ID mismatch	20	Open Echelon controller Program ID does not match expected Program ID.
Proof Fail	User	A proof checking device is registering a failure in one of the Application's control devices.
Proof Failure Occurred	User	A proof checking device is registering a failure in one of the Application's control devices.
Proof Reset-Stage In retry	50	Due to a FAIL signal from a proof checking device, the E2 is attempting to reset the proof failure.
Rack Failure Occurred	User	A Suction Group application is registering a total rack failure.
REFR Phase Loss	User	A phase loss device connected to Global Data has switched ON to shut down all refrigeration systems.
REFR Shutdown	User	A Global Data application's REFR Shutdown input has turned ON to shut down all suction groups, condensers, and circuits.
Relativ Adv: No Active Setpt	99	An application that is supposed to be generating an alarm for a specified input has no active setpoint to use for alarming. This usually occurs when alarm setpoints are supplied by other applications or inputs, and the application or input fails.
Resize bad! Logging Terminated	10	The number of samples was changed in a log group and the resizing of the file storing data was not successful. Check memory.
Runtime Log Stuck-No Memory	15	A Runtime Log is unable to save new data because there is not enough memory.
Runtime Logs Not Restored	15	The runtime logs stored in memory were not restored after the last reset or upgrade.

Alarm Name	Default Priority	Definition
RX/BX Firmware Update Failed	20	The E2's firmware update was not successful.
RX/BX Firmware Was Updated	50	The E2's firmware was successfully updated.
Smoke Detected	30	A smoke detector input on an ARTC/MultiFlex RTU has detected smoke.
SRAM Memory Corrupted - Reboot	30	A problem with memory has resulted in a reset of the E2.
State Switched 'On'	User	A digital value that has been set up to alarm when ON has switched ON.
Status Config Loss-CRC Error	30	An internal error has occurred in the E2.
Stuck	30	MultiFlex ESR controller has detected a stuck valve.
System date needs manual reset	20	The date/time of the box is not valid.
System In Pump Down	User	The suction pressure has fallen below the pump down setpoint for a Suction Group, causing shutdown of the rack.
Template File Bad - CC100 Liq	15	A template file in E2 for a CC-100P or CC-100LS is bad.
Template File Bad - CC100 Suct	15	A template file in E2 for a CC-100H is bad.
Template File Bad - CS100 Ckt	15	A template file in E2 for a CS-100 is bad.
Test Dial Successful	50	E2 performed a test dial-out with its modem, and the dial-out was successful.
Time Updated By A User	99	A user changed the time in the current E2.
Time Updated Over Network	99	The time in the current E2 was updated by another controller or user on the network.
Timed Out Waiting For FW Updt.	50	The E2 waited for a firmware update to begin, and it never did.
Too Many Reboots: Flash erased	50	A number of successive reboots has erased the Flash RAM.
Too Many Reboots: SRAM erased	50	A number of successive reboots has erased the SRAM.
Total On Time Exceeded Limit	User	A digital value's total ON time has exceeded its defined Time ON Total setpoint.
Trip Alarm	30	Generic pulse trip alarm.
Tripped	20	WPK condenser fan or compressor trip.
Unit Ctr Cell Create Failed	20	The E2 unsuccessfully tried to create a unit controller cell.
Unknown FW Update Attempted	50	An error has occurred during a firmware update of E2. Call Retail Solutions service for assistance.
Unknown Heap Operation Error	50	There is an internal error in the E2 software. Notify Retail Solutions service.
Unoccupied Hi Limit Exceeded	User	An analog value has risen above its defined high limit setpoint during UNOCCUPIED mode.
Unoccupied Low Limit Exceeded	User	An analog value has fallen below its defined low limit setpoint during UNOCCUPIED mode.



Alarm Name	Default Priority	Definition
User Cleared All Applications	50	A user has cleared out all data from all applications in this E2.
User/Appl. Forced Reset	50	A user or an application has forced a reset of this E2.
VS Alarm	20	Multiflex PAK variable speed device alarm.
VS Inverter Fail	User	A variable-speed inverter driving a variable-speed fan or compressor has failed.
WCC Controller Alarm	20	Woodley case controller alarm.
WPK Controller Alarm	20	Woodley Pack Amps Fail alarm.
Watchdog Countdown Hit Zero	20	E2 locked up while trying to perform a task. If this alarm occurs often, there may be a problem with your system. Contact Retail Solutions service.
Watchdog Reset Timer Failed	20	E2 tried to reset itself to clear a hung task, but the “watchdog” feature on the E2 was disabled. Check the jumper J19 labeled “Watch Dog” on the E2 main board. This jumper should be either be set to “ENABLE” or it should not be present at all.
X300<->X300 Links Lost-CRC Err	20	An internal error has caused a loss of communication between E2s.

Appendix D: PID Control

Introduction to PID Control

PID Control is a specialized method of closed-loop control that strives to maintain equality between an input value and a user-defined setpoint by operating a device or a number of devices at somewhere between 0% and 100% of full capacity.

PID Control works by making adjustments to the output at a constant rate called the **update rate** (usually 2-6 seconds). For every update that occurs, PID Control takes a reading from the input sensor or transducer, measures the distance between the input and the setpoint (also called the **error**), makes a series of calculations, and adjusts the output percentage in such a way as to move the input towards the setpoint in the most efficient manner.

The “calculations” that determine the new value of the

P Proportional Mode	Tries to stop the error from changing. Measures difference between current and previous error, and adjusts output percentage to prevent any further movement.
I Integral Mode	Tries to bring the error to zero (input = setpoint).
D Derivative Mode	Tries to slow or stop a rapidly changing error so P and I Modes may effectively work to eliminate it.

Proportional (“P”) Mode

The Proportional Mode in PID determines the system’s immediate reaction to a change in the error. Proportional Mode simply analyzes the difference between the current error and the previous error. Based on the size of this difference, Proportional Mode will make a change to the output in an attempt to stabilize the input value and keep it from changing any further.

Mathematically, the following equation determines the “P” Mode adjustment for a single update:

$$\text{“P” mode adjustment} = K_p (E - E_{-1})/TR$$

K_p = proportional constant

E = current error

E_{-1} = error during last update

TR = throttling range

Throttling Range

In simplest terms, the Throttling Range is the number

output after each update are made by three different modes of control: Proportional (“P”) Mode, Integral (“I”) Mode, and Derivative (“D”) Mode. Each mode of control makes its own adjustment to the output percentage, and the three adjustments are added to the previous output percentage to determine the new output percentage. In mathematical terms, every update will affect the output percentage as follows:

$$\text{NEW OUT\%} = \text{OLD OUT\%} + (\text{“P” mode adjustment}) + (\text{“I” mode adjustment}) + (\text{“D” mode adjustment})$$

Each of the three modes (P, I, and D) serves a different and important purpose, as described below:

of input value units between a 0% output and a 100% output. For example, in a Case Control application, the Throttling Range would be the number of degrees between the input temperature that would result in a 0% output and the temperature that would cause a 100% output. Therefore, the Throttling Range essentially determines the percentage of the output adjustment that will be added to the previous percentage when a change in input occurs.

PID Control places this Throttling Range around the setpoint. As a result, Proportional Mode works to keep the temperature near the setpoint and within the throttling range. In most cases, the Throttling Range straddles the setpoint evenly on both sides, as shown in **Figure D-1**. However, in some applications such as Condenser Control, the Throttling Range may be placed elsewhere see

Throttling Range on page D-1.

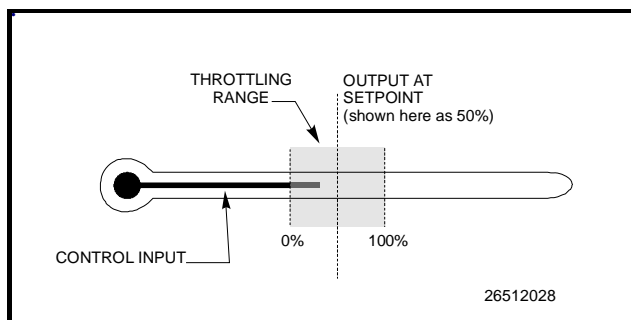

Figure D-1 - Throttling Range

Example 1: Suppose a Case Control application has a throttling range of 10 degrees. Also, for simplicity's sake, assume only the Proportional Mode is active and the proportional constant K_p is one. The system begins with a 0% output at the bottom of the Throttling Range and with an input value of 24°F. Because the throttling range is 10 degrees, Proportional Mode will gradually add 100% to the output percentage as the input changes to 34° over time.

Suppose, for example, the input increases by one degree every time an update occurs. The following adjustment would then likewise occur after every update:

$$\text{"P" mode adj.} = (1.0)(1 \text{ degree}) / 10 \text{ degrees} = 0.1 = 10\%$$

After 10 updates, the input value would be 34°F and the output would be 100%. The same would happen if it were five updates at two degrees each or one hundred updates at 0.1 degrees each. In every case, the temperature travels a total of 10 degrees, and because the throttling range is also 10 degrees, the output travels from 0% to 100% proportionally.

Higher Throttling Range values will result in a wider 0-100% range, and therefore will result in smaller reaction to changes in input values.

Proportional Constant (K_p)

The Proportional Constant is simply a multiplier that can be used to fine-tune the size of the Proportional Mode adjustment. Raising the value of K_p results in a greater reaction to input value changes, while lowering it results in a smaller reaction.

Changing K_p is essentially the same thing as changing the value of the throttling range. For example, having a TR of 10 and a K_p of 2 is the same as having a TR of 5 and a K_p of 1. Mathematically speaking, the effective proportional range is calculated by dividing the Throttling Range by K_p .

If Proportional Mode is functioning incorrectly in your system, it may be more appropriate for you to change the Throttling Range value to a more appropriate value. K_p is designed as a fine-tuning constant (for example, it might be used to speed up reaction slightly by setting it to 1.04, or to slow down reaction by setting it to 0.98).

Integral Mode

The Integral Mode (also called "I" Mode) is the portion of PID control that seeks to make the input equal to the setpoint. When an update occurs, the Integral Mode measures the difference between the current input value and the setpoint. The size of this difference determines Integral Mode's output percentage adjustment.

Why "I" Mode is Necessary

Though Proportional Mode handles the majority of the workload during PID control, there are two major shortcomings that make the "I" Mode necessary.

Proportional Offset

Proportional Mode, if left to operate all by itself, is only capable of stopping the error from changing. When the error is not changing, neither is the "P" portion of the output. This means the system may reach stability at any value, regardless of whether it is above or below the setpoint (see **Figure D-2**). Proportional Mode alone has no mechanism that can bring the error to zero after stability has occurred. The "I" Mode is necessary in order to move the input in the direction of the setpoint.

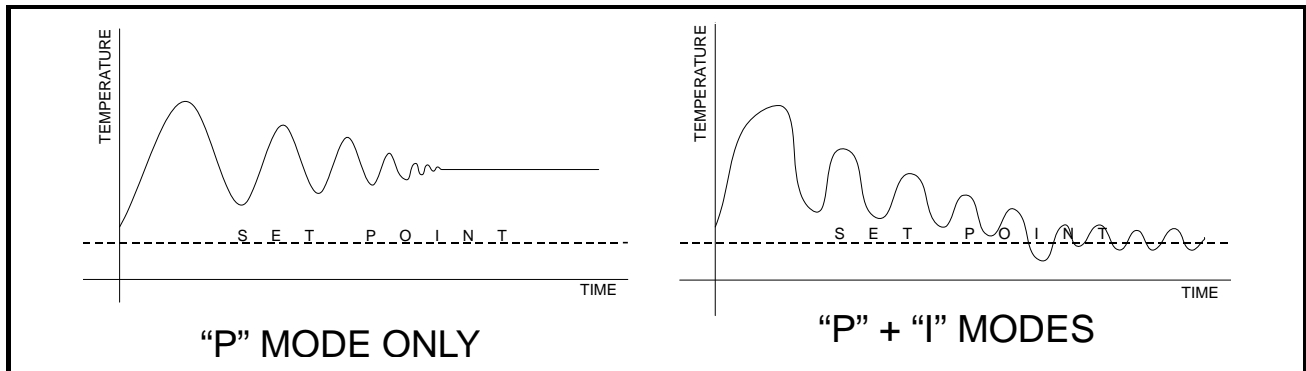

Figure D-2 - Comparison of “P” Mode vs. “P” + “I” Mode

Saturation

Once the input value has wandered outside Proportional Mode’s throttling range, the output percentage will be at 0% (if below the Throttling Range) or at 100% (if above the Throttling Range). At this point, PID is considered to be in saturation, meaning it is operating at full (or zero) capacity and is not able to react any further to changes that occur beyond the throttling range.

Proportional Mode cannot distinguish between a saturated and an unsaturated system; it simply makes proportional adjustments to the output percentage. Therefore, once an input value in a saturated system changes direction, Proportional Mode reacts to correct the movement, regardless of how much error exists. As the temperature changes direction and again moves in the direction of the

setpoint, Proportional Mode will reduce the 100% output percentage in an attempt to stop the movement and stabilize the temperature.

To put it another way, when a system is saturated, the input changes the placement of the Throttling Range. As shown in *Figure D-2*, as the input rises above the Throttling Range, the top end of the Throttling Range rises with it. When the input finally changes direction, the Throttling Range remains at its new position.

The “I” Mode covers for Proportional Mode’s inability to account for saturation. When the input value is outside the throttling range, “I” Mode will continue to adjust the output percentage to bring the input value towards the setpoint

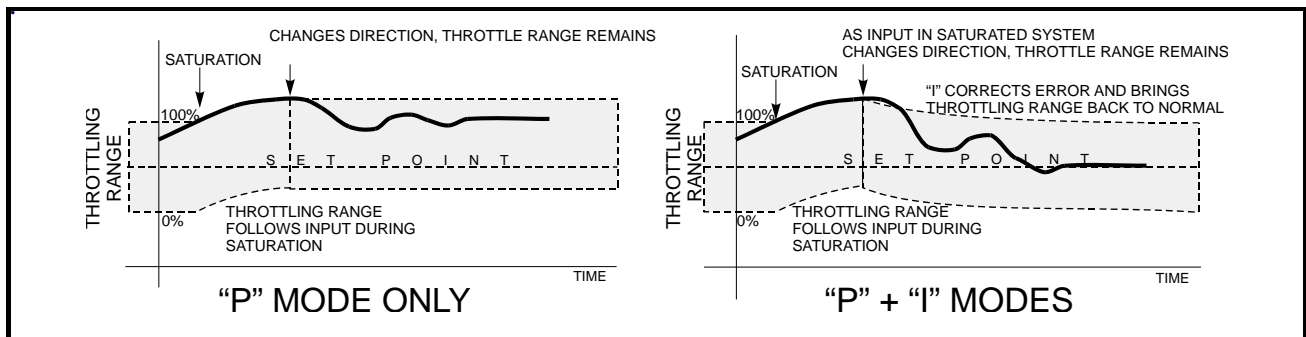

Figure D-3 - Saturation in “P” vs. “P” + “I” Modes

The “I” Mode Calculation

To determine the “I” Mode adjustment for each update, the following calculation occurs:

$$\text{“I” mode adjustment} = K_i * (\text{current error})$$

K_i in this equation is called the **integral constant**. It is simply a multiplier that increases or decreases the speed at which the “I” Mode will increase or decrease the percentage.

When changing the value of K_i , it should be noted that small adjustments yield large results. For this reason, it is suggested that K_i should remain close to 1.0 and certainly no less than 0.5 and no greater than 2.0.

Derivative Mode

The Proportional and Integral Modes provide a good method of controlling a closed-loop system. However, in special circumstances where the input value is changing rapidly, there may be a lag time between when the error is noted and the length of time it takes the system to compen-

sate for error.

To reduce this lag time, Derivative Mode is used. Derivative Mode constantly analyzes the rate of change of the error, makes a prediction about what the future error will be, and makes an adjustment to the output in an attempt to reduce the rate of change in the error.

In layman's terms, Derivative Mode causes PID control to "overshoot" the amount of output percentage to compensate for the slow reaction times of the P and I Modes. As a result, Derivative Mode slows the rate error change down to a level the P and I Modes can handle.

The "D" Mode Calculation

To determine the "D" Mode adjustment for each update, PID performs the following calculation:

$$\text{"D" mode adjustment} = K_d * (E - (2E_{-1}/\Delta t_{-1}) + (E_{-2}/\Delta t_{-2}))$$

K_d = derivative gain

E = current error

E_{-1} = error from the previous update

Δt_{-1} = the amount of time elapsed since the previous execution

E_{-2} = error from the update before the previous update

Δt_{-2} = the amount of time elapsed between 2 executions ago and the previous execution

The factors $E_{-1}/\Delta t_{-1}$ and $E_{-2}/\Delta t_{-2}$ are the rates of change of the error (in units per minute). The rate of change for the previous error (E_{-1}) weighs twice as much in the

Derivative Mode calculation as the 2nd previous error (E_{-2}), since E_{-1} is closer to the current rate of change than E_{-2} .

The derivative gain K_d is a multiplier that changes the total size of the Derivative Mode adjustment. If Derivative Mode is causing PID control to react too quickly or too slowly, the derivative gain may be adjusted to correct the problem. Higher values of K_d result in quicker reactions; lower values result in slower reactions.

How Condenser Control and HVAC PID Differs From The Others

The RMCC approaches condenser control and HVAC control from a different angle than other PID-controlled systems such as Pressure Control and Case Control. PID control for Pressure Control and Case Control seeks to maintain a constant equality between the input and the setpoint. Specifically, in Pressure Control, the RMCC tries to keep the suction pressure or temperature equal to the suction setpoint, and in Case Control, the RMCC tries to keep

the case temperature equal to the temperature setpoint.

Condenser Control and HVAC Control seek only to keep pressure or temperature values below or above their setpoints. Thus, the system is only concerned when the input value is on the wrong side of the setpoint (e.g., above the setpoint in Condenser Control and Cooling Control, or below the setpoint in Heating Control). Any value on the other side of the setpoint is considered an acceptable value for the purposes of controlling, and therefore the output will be at or near 0%.

Condenser PID and HVAC Cooling Control only react to pressure or temperature levels that climb above the setpoint. Likewise, in HVAC Heating Control, the temperature level must be below the heating setpoint in order to begin heating. The 0-100% output percentage is then determined based on the distance between the input and setpoint, and the rate of change.

Output at Setpoint

Mathematically, the only difference between PID for Condenser and HVAC Control and PID for other systems is the **Output at Setpoint** value.

The Output at Setpoint value is simply the percentage the output will be when the input value is stabilized at the setpoint. In other words, when the PID input equals the PID setpoint, the PID output percentage will be fixed at the Output at Setpoint value.

Output at Setpoint is the value that determines where the throttling range is placed. As mentioned in "Throttling Range" on page 1, the Throttling Range is the range of input values across which Proportional Mode will gradually move the output percentage from 0% to 100% (excluding effects by the Integral and Derivative Modes). The Output at Setpoint value basically tells the RMCC where to place the Throttling Range in relation to the setpoint (this is explained in further detail below).

Output at Setpoint for Non-Condenser/HVAC PID

For all non-condenser and non-HVAC PID control, the Output at Setpoint is fixed at 50% (except for Analog Output Modules, which may be programmed with any value from 0-100%). As mentioned before, this means that PID control will constantly strive to achieve a stable system where the input is equal to the setpoint and the output is 50%.

The throttling range in a PID Control application with a 50% Output at Setpoint is placed in such a way as to put the setpoint right in the middle of the throttling range, as shown in *Figure D-3*.

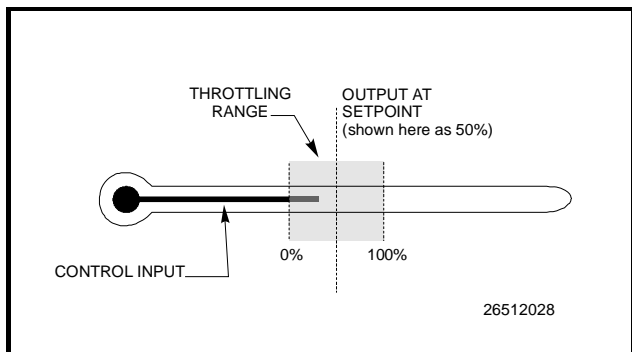

Figure D-4 - Centered Setpoint PID Control (Output @ Setpoint = 50%)

Therefore, as the input value gradually drops below the setpoint, the Proportional Mode of PID will gradually bring the output percentage down. When the input drops below the low end of the throttling range, the output will be zero.

The opposite happens with the input value begins to rise above the setpoint. The output percentage is gradually brought up from 50% until, when the input is at or above the throttling range, Proportional Mode will bring the output to 100%.

Output at Setpoint for Condenser/HVAC PID Control

For Condenser and HVAC PID Control, the Output at Setpoint defaults to 0%. This places the 0% end of the Throttling Range at the setpoint value, and it generally means Proportional Mode will strive to pull the input back down below the setpoint and attain a 0% output percentage. As the input climbs from the setpoint to the top of the Throttling Range, Proportional Mode likewise increases the output percentage to 100%.

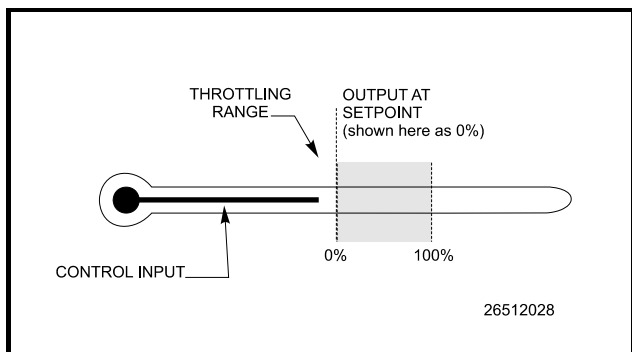

Figure D-5 - End Setpoint PID Control (Output @ Setpoint = 0%)

The differences between the two PIDs can be seen by observing the throttling ranges. For non-Condenser Control applications, PID reacts to error that exists on either side of the setpoint. If the input goes lower than the set-

point, the output percentage is dropped from 50% (it is assumed this will result in the input rising back to the setpoint). Likewise, when the input is higher than the setpoint, the output percentage is raised. For Condenser Control PID, no reaction is made to an input that is lower than the setpoint, since the output percentage is already 0%.

Changing the Output at Setpoint

Advanced users may wish to change the Output at Setpoint in order to change the stabilization characteristics of their system(s). In most cases, the default values of the Output at Setpoint (0% for Condenser Control and HVAC, 50% for all others) are appropriate and recommended. Changing the value of the Output at Setpoint may have some beneficial results, but at the same time it may also hamper the system's ability to react to changing conditions, and it may also result in decreased energy efficiency.

Other PID Features

The following section lists other PID-related constants or control structures that are a part of some PID control algorithms. Many of these features are advanced features that are accessible only by service personnel or advanced users. As a general rule, it is best to contact Retail Solutions before changing any of these values.

Output at Minimum / Output at Maximum

The Output at Minimum and Output at Maximum values are used to change the range of possible output percentages. The default values (0% for minimum, 100% for maximum) allow the output to vary from fully off to fully on; changing these values, therefore, would only be necessary if you desire a limited output range.

Two things occur when the Output at Minimum or Output at Maximum values are changed:

1. The throttling range is shortened as dictated by the new values. For example, if you specified a 20% minimum, the portion of the throttling range that would usually represent the range of outputs from 0% to 20% is cut off. Any input value that falls within the previous 0% to 20% portion of the throttling range will cause the Proportional Mode to move the output towards 20%.
2. The Output at Minimum or Output at Maximum value replaces any calculated adjustment that would normally call for the output to be outside of the specified range. In other words, if the Output at Minimum and Output at Maximum values

are 20% and 100% respectively, the output percentage will never be below 20%, even if the P, I, and D Mode adjustments call for the output to be below 20%. The output will remain in saturation at 20% until a higher output percentage is called for.

In short, PID works as it normally does, except the output never goes below Output at Minimum or above Output at Maximum.

Minimum Accumulated Error

The Minimum Accumulated Error setting disables error accumulation in the “I” Mode when the current error is equal to or less than a certain amount. For example, if the PID setpoint is 30 and the Minimum Accumulated Error is 1, the “I” Mode will not adjust the PID output percentage as long as the input is between 29 and 31.

Because “I” Mode does not accumulate error within the Minimum Accumulated Error range, the control input is allowed to settle on a value other than the setpoint. It is possible in the example given above for the system to achieve stability at any value between 29 and 31 without the “I” Mode trying to bring the error to zero.

Application

The practical use of Minimum Accumulated Error is to set up a “close enough” zone around your PID setpoint. When the control input is within the zone, PID will not worry about making any “I” adjustments to attempt to equalize the input and the setpoint. Proportional Mode will handle any minor input changes that occur within this zone.

Filtering

Filtering is a feature commonly used by CC-100s in valve control (and it thus sometimes called “valve filtering”). The primary purpose of filtering is to dampen the rate of change of the PID percentage in an effort to make the PID control loop less reactive.

The filtering feature takes samples of the PID output percentage at regular intervals (which are determined by a parameter called the **filter period**). Every time a new filter period interval occurs, the PID percentage sampled during the last period interval is subtracted from the current PID percentage from the current period interval.

The result of this subtraction is multiplied by a parameter called the **filter percentage (0 - 100%)** to yield the actual amount the PID percentage will change.

Over time, the application of the filter percentage to the change in PID position will result in a PID control loop with a smaller amount of reaction to changes in the input.

Example: A stepper EEV valve on a CC-100 is con-

trolled by PID control. Valve filtering is active in this CC-100, with the filter period set to six seconds and the filter percentage set to 75%.

During one sample taken during a period interval, the CC-100 calls for a valve position of 50%. One period (six seconds) later, the CC-100 asks for a 58% valve opening.

The total difference between the current sample and the previous sample is +8% (58 - 50%). To determine the actual amount the valve will change, the CC-100 multiplies the filter percentage (75%) with the total amount of valve position change (8%). As a final result, the new PID output value for the CC-100 will be 56%.

Note that filtering only slows down the reaction of the PID loop. When the control input is stabilized, the PID loop will eventually achieve the output percentage it is calling for.

To demonstrate this, suppose in the example above the CC-100 continues to call for a 58% output during the period immediately after the 6% adjustment. Since the total difference between the asked-for percentage and the current actual percentage is 2% (58 - 56), valve filtering will make the new adjustment for that period 1.5% (75% of 2). As a result, the new valve output would be 57.5%. Future filter periods will bring the actual output even closer to the asked-for output.

Application

PID filtering is used for systems that appear to be overreacting to changes in the control input. If filtering is to be used at all, it is recommended to use caution, since even a small amount of filtering may cause the PID loop to become underreactive.

Appendix E: Compressed Point Log Sample Limits and Precision Table

Engineering Unit	Medium Resolution			Low Resolution		
	Low Clip	High Clip	Precision	Low Clip	High Clip	Precision
Temperature						
Degrees Centigrade*	-200	1,500	0.0259427	-40	97.7778	0.555556
Degrees Fahrenheit	-328	2,732	0.0466969	-40	208	1
Differential Temperature						
Delta Degrees Centigrade*	-200	200	0.00610417	-68.889	68.889	0.555556
Delta Degrees Fahrenheit	-360	360	0.0109875	-124	124	1
Temperature Change Rate						
Degrees Centigrade Per Minute*	-50	50	0.00152604	-6.889	6.889	0.055556
Degrees Fahrenheit Per Minute	-90	90	0.00274688	-12	12	0.1
Degrees Centigrade Per Hour	-3,000	3,000	0.0915625	-413.333	413.333	3.3333
Degrees Fahrenheit Per Hour	-5,400	5,400	0.164813	-744	744	6
Pressure						
Pascals*	-100,000	20,000,000	306.734	-100,000	4,200,000	17339
Kilopascals	-100	20,000	0.306734	-100	4,200	17.3387
Pounds Per Square Inch	-14.50	2,901	0.0444881	-14.5038	609.160	2.51477
Bars	-1	200	0.00306734	-1	42	0.173387
Pascals (low readings)*	-1,250	5,000	0.0953776	-1,250	3,500	19.1532
Inches of Water	-5.02	20.0732	0.000382906	-5.018	14.0512	0.0768931
Centimeters of Water	-12.75	50.9870	0.000972604	-12.7468	35.6909	0.195313
Differential Pressure						
Delta Pascals	-2,000,000	2,000,000	61.0417	-500,000	500,000	4032.26
Delta Kilopascals	-2,000	2,000	0.0610417	-500	500	4.03226
Delta Pounds Per Square Inch	-290.08	290.076	0.00885336	-72.5190	72.5190	0.584831
Delta Bars	-20	20	0.000610417	-5	5	0.0403226
Delta Pascals (low readings)*	-3,000	3,000	0.0915625	-1,000	1,000	8.06452
Delta Inches of Water	-12.04	12.0439	0.000367590	-4.01463	4.01463	0.03237606
Delta Centimeters of Water	-30.59	30.5922	0.000933700	-10.1974	10.1974	0.08223710
Humidity						
Relative Humidity*	0	100	0.00152604	0	100	0.403226
Light Level						
Lux*	0	25,000	0.381510	0	10,000	40.3226
Foot-Candles	0	2,323.5	0.0354576	0	929.400	3.74758
Electrical Voltage						
Volts*	-3,276.8	3,276.1	0.1	0	496	2
Electrical Current						
Amps*	0	6,552.90	0.1	0	4,960	20
Milliamps	0	6,552,900	100	0	4,960,000	20000
Electrical Resistance						
Ohms*	0	655,290	10	0	496,000	2000
Power						
Watts*	0	6,552,900	100	0	496,000	2000



Kilowatts*	0	6,552.9	0.1	0	496	2
Energy						
Watt-Hours*	0	131,058,000	2000	0	9,920,000	40000
Kilowatt-Hours*	0	131,058	2	0	9,920	40
Parts Per Million						
Parts Per Million*	0	32,764.5	0.5	0	2,480	10
Percentage						
Percentage*	0	200	0.00305208	0	124	0.5
Revolutions Per Minute						
Revolutions Per Minute*	0	65,529	1	0	2,480	10
RPM Change Rate						
Revolutions Per Minute Per Minute*	0	6,552.9	0.1	0	4,960	20
Time						
Milliseconds*	0	65,529	1	0	248	1
Seconds*	0	65,529	1	0	248	1
Minutes*	0	65,529	1	0	248	1
Hours*	0	6,552.9	0.1	0	248	1
Days*	0	6,552.9	0.1	0	248	1
Months*	0	6,552.9	0.1	0	248	1
Years*	0	6,552.9	0.1	0	248	1
Time (seconds display)*	0	65,529	1	0	248	1
Time (minutes display)*	0	6,552.9	0.1	0	248	1
Time (hours display)*	0	6,552.9	0.1	0	248	1
Volume						
Liters*	0	248,056	3.78544	0	9,387.894	37.8544
Gallons	0	65,529	1	0	2,480	10
Cubic Meters*	0	1,855.57	0.0283168	0	70.2258	0.283168
Cubit Feet	0	65,529	1	0	2,480	10
REU_CCF*	0	65,529	1	0	248	1
Volume Change Rate (liquid)						
Liters Per Second*	0	65.529	0.001	0	7.82319	0.0315451
Gallons Per Minute	0	1,038.66	0.0158503	0	124	0.5
REU_CCFH*	0	655.29	0.01	0	25	0
Volume Change Rate (gas)						
Cubit Meters Per Second*	0	30.9262	0.000471947	0	1.17043	0.00471948
Cubic Feet Per Minute	0	65,529	1	0	2,480	10
Distance						
Meters*	0	65,529	1	0	248	1
Feet	0	214,990	3.28084	0	813.648	3.28084
Inches	0	65,529	1	0	248	1
Centimeters	0	65,529	1	0	248	1
Distance Change Rate (speed)						
Meters Per Second*	0	332.89	0.005080	0	248	1
Feet Per Minute	0	65,529	1	0	48,818.9	196.850
Meters Per Minute	0	19,973	0.304800	0	14,880	60
Frequency						
Hertz*	0	6,552.9	0.1	0	248	1
Weight						
Pounds (lb)	0	1,444.6	0.2	0	546.7	2.2
Kilograms (kg)	0	655.3	0.1	0	248	1

Appendix F: Troubleshooting

The chart below describes symptoms and solutions if troubleshooting the system or equipment is needed. For further information, contact Retail Solutions Service at 1-800-829-2724.

SYMPTOM	POSSIBLE PROBLEM	SOLUTION
I/O Network Problems	I/O board not getting power.	Check I/O board power--is the green STATUS light on? If not, check power wiring connections, and use a multimeter to verify the board is getting 24VAC. Reset power to board.
	I/O board not communicating or won't come online.	Check I/O network connections: 1. Check wire polarity (positive to positive/negative to negative) 2. Check for broken or loose wires.
	Dip switches are set incorrectly.	Check I/O board network dip switches. Verify network ID number is not a duplicate and that baud rate switches are set to 9600. (If switches are wrong, make changes and then reset the controller.) Refer to Section 6.1.6, Network ID Numbers (Board Numbers) .
	Terminating resistance jumpers are set incorrectly.	Check for proper setting of terminating resistance jumpers. Network segment should be terminated on the two endpoints of the daisy chain and unterminated everywhere else. Refer to Section 6.1.8, Setting the Terminating and Biasing Jumpers .
	Boards are not powered.	Check Network/Power voltages. Refer to Section 6.1.9, Powering the I/O Boards .



SYMPTOM	POSSIBLE PROBLEM	SOLUTION
Echelon Network Problems	Faulty wiring.	Check connections. Are wires broken or loose? Check network polarity (positive to positive/negative to negative). Check for wire damage.
	Termination jumpers are set incorrectly.	Check for proper setting of terminating resistance jumpers. Network segment should be terminated on the two endpoints of the daisy chain and unterminated everywhere else. Refer to Section 8.4, Device Termination .
	Subnet (unit #) is set incorrectly.	Each controller must have its own subnet address. Refer to Section 8.3, Echelon Network Structuring (Daisy-Chains) .

SYMPTOM	POSSIBLE PROBLEM	SOLUTION
Compressor will not Operate	Compressor is not programmed properly.	Verify that E2 was programmed for correct number of compressor stages. Highlight the General tab (C1) in the Suction Group Setup screen. Is the correct number of stages in the “Number of Stages” field?
	Compressor types are set up incorrectly.	Make sure that compressor stages were properly set up as VS (variable speed), C (compressor), or U (unloader).
	Compressor programmed with incorrect rating.	Verify that compressors were assigned the proper rating (HP/AMP, or BTU).
	Pressure setpoints are set up incorrectly.	Set proper pressure setpoints. If you are controlling the rack using suction pressure, enter the pressure setpoint in the SUC PRES SETPT field. If you are controlling by temperature, enter the temperature setpoint in the CTRL TEMP SETPT field. Note: Pressure setpoints are located under the Setpoints tab (C2) in the Suction Group Setup screen.
	Board and point addresses are incorrect.	Set proper board and point settings for input, output, and compressor outputs. Board and point settings are located under the Inputs tab (C4), Outputs tab (C5), and Comp Outs tab (C7) in the Suction Group Setup screen.



SYMPTOM	POSSIBLE PROBLEM	SOLUTION
Compressor will not Operate (Cont.)	8RO fail-safes are not wired correctly.	Verify fail-safe wiring on 8RO board for N.O./N.C. positions. One wire of the two-wire connection should always be connected to the middle terminal. The second wire must be either connected to the N.C. terminal (if you want the relay to be closed (ON) during power failure) or the N.O. terminal (if you want the relay to be open (OFF) during power failure.)
	Compressor in override.	Highlight compressor stage and cancel the override by pressing Enter to open the Actions Menu. Select 3 for Override options, or go to the Override/Bypass Log to view and cancel overrides: 1. From the Main Menu, press 8 to open the Status menu. 2. From the Status menu, press 4 for the Graphs/Logs menu. 3. Press 3 for the Override/Bypass Log. (This screen gives you quick access to all overrides/bypasses in the system)
	Rack is in Phase Fail.	Verify correct phase and verify correct input for phase loss. If you specified that phase protection would be used on this rack, the Phase Loss input is displayed. The Phase Loss input is automatically configured to use E2's Global Data phase loss protection source. If you wish to define a different source, re-define this input definition. To point this input to a board and point address: press F3 (EDIT) and then 1 to change the definition format.
	Oil sensors are set up but are not in use.	Remove oil sensors from individual compressors. 1. Highlight the Comp Setup tab (C6) in the Suction Group Setup screen. 2. Use the arrow keys to select the OIL SENSOR field. 3. Choose "None" from the LOOK UP menu.

SYMPTOM	POSSIBLE PROBLEM	SOLUTION
Problems with Condenser	Condenser will not operate.	Verify that E2 is programmed with proper number of fans. 1. Highlight the General tab (C1) in the Condenser Setup screen. 2. Is the correct number of fans in the Number of Fans field?
	Incorrect board and point settings.	Confirm proper board and point settings: Go to the Inputs tab (C3) in the Condenser Setup screen to check PRES CRTL IN and DISCH TRIP IN.
	Fail-Safe wiring on 8RO is incorrect.	Verify proper fail-safe switch positions on the 8RO board. The fail-safe dip switches are labeled S2 on the 8RO and S3 on the 8ROe and 8IO. Set the rocker UP (ON) to close the relay and turn the output ON during network failure. Set the switch DOWN (OFF) to open the relay and turn the output OFF during network failure.
	Condenser will not split.	Enable the condenser to split. Go to the General tab (C1) in the Condensers Setup screen and set the Split Enable field to Yes .
	Unsplit setpoint is set too low.	Unsplit setpoint value is compared with discharge pressure value instead of temperature. Enter the value in terms of discharge pressure. Go to the Setpoints tab (C2) in the Condensers Setup screen and check that the UNSPLIT STPT field value has been entered as a pressure value.
	Half of the fans are not running.	Check the split fan relay output: 1. Go to the Other Outs tab (C7) in the Condensers Setup screen and check that SPLIT FAN has a board and point assignment. 2. Verify Split is enabled: Go to General tab (C1) in the Condensers Setup screen and set the Split Enable field to Yes . 3. Verify output is ON.



SYMPTOM	POSSIBLE PROBLEM	SOLUTION
Problems with Cases	Case will not go into hot gas or cool gas defrost.	Check Group LLSV in Suction Group setup: 1. Go to the Outputs tab (C5) on the Suction Groups Setup screen and check GROUP LLSV. 2. Verify that the case(s) is assigned to the correct group.
	Case will not terminate out of defrost mode.	1. Verify the termination type (Term Type) in the Defrost tab (C4) in the Standard Circuits Setup screen. 2. Check the defrost termination input location on circuit input. 3. Go to the Inputs tab (C6) and check DEFROST AV TERM.
Problems with Global Actions	Information cannot be read from another E2 controller.	Verify that the controller with the sensor is set up as the Primary and the controller receiving the information is set up as the User (both controllers default as local).

SYMPTOM	POSSIBLE PROBLEM	SOLUTION
Problems with Temp Sensor or Pressure Transducer Displaying Proper Value	16AI input dip switches are set improperly.	The 16 dip switches on the 16AI board correspond to each of the inputs: Dip Switches Up = Temperature Sensor Dip Switches Down = Pressure Transducer
	Incorrect board and point address.	Set proper board and point settings for both input and output: Go to the Inputs tab in the application's Setup screen and check Board and Point.
	Incorrect sensor type.	1. Verify that the sensor type in E2 is the same as the sensor installed. (For example, "5V-200PSI" is a 5-volt powered 200PSI pressure transducer, and "Temperature" is the standard Retail Solutions temperature sensor. NOTE: The previous Eclipse and Standard sensors are now 5V and 12V respectively. 2. From the Main Menu, select System Configuration (7) and Input Definitions (1). 3. Highlight the desired input and press F1 (SETUP) to check Sensor Type.
No Heat or Air Will Come On	Incorrect board and points assignment.	Make sure that your board and points are assigned to the correct compressors and heat stages
	Check the Heat and Cool OAT lockout temps.	From the Home screen, press F1 (AHU), F5 (SETUP). Move cursor to C5 (HT/CL Setup) to check the Lockout temperatures.



SYMPTOM	POSSIBLE PROBLEM	SOLUTION
Dehumidification Problems	Number of stages are not set up or set up incorrectly.	From the Home screen, press F1 (AHU), F5 (SETUP). Move cursor to C9 (Dehum) to check Dehum Stages.
	Dehumidifier source not set up.	From the same screen, verify what the sensor source is.
	Temperature setting for DEHUM OCC or DEHUM UOC is set too high.	From the same screen, check the minimum temperature setting.
Lighting Control Problems	Lights will not come on.	Make sure you have a Time Schedule set up. A Time Schedule is not Lighting Control. You can use the same Time Schedule for several Lighting Controls. Set up the Time Schedule first and then assign it to a Lighting Control.
		Set up a Time Schedule and got to Lighting Control. Choose the desired application and press F5 (SETUP). Move the cursor to C7 (Inputs) and highlight the Board field. Press F4 (LOOK UP), choose the input device and press Enter . Highlight the Point field and press F4 (LOOK UP). Select the type of schedule and press Enter .
		Make sure Lighting Control output is assigned.
Lights Will Not Come On With The Photocell	Photocell is not recognized by controller.	Make sure the photocell is configured as an analog input.
		Verify that the type of light sensor is correct.
		If using a light level sensor from another E2 controller, set it up on the controller it is associated with in the Global Data section.

Index

Numerics

16AI Analog Input Board
 input type dip switches *9-1*
 power connections for sensors *9-2*
 specifying the number of *10-2, 10-15*
 wiring input devices to *9-1*

16AIe Analog Input Board
 defined *2-10*
 detail *2-10*

4AO Analog Output Board
 features *2-9*
 specifying the number of *10-2, 10-15*

8DO Digital Output Board
 defined *2-9*
 location *3-3*
 mounting without enclosure *3-4*
 specifying the number of *10-2, 10-15*

8IO Combination Input/Output Board
 input labeling *9-1*
 input type dip switches *9-1*
 numbering *6-3*
 power connections for sensors *9-2*

8RO Relay Output Board
 defined *2-8*
 features *2-8*
 mounting in enclosure *3-3*
 mounting without enclosure *3-4*
 specifying the number of *10-2, 10-15*

8RO/8ROSMT Board *2-8*

8ROe Relay Output Board
 defined *2-10*
 detail *2-10*

8ROSMT
 Relay Output Test Mode *9-11*

-A-

Access Levels *10-13*
 guidelines *10-13*

Accessing the Alarm Advisory Log *12-12*

Accounts
 creating a new user *10-14*
 deleting a user *10-14*

Acknowledged State *12-13*
 advisory message *12-13*

area ctrl/application/property *12-13*

Acknowledging *12-13*

Acknowledging, Resetting, & Clearing Log Entries *12-13*

Actions Menu *10-6, 12-4*

Advanced Rooftop Controller
 input labeling *9-1*

Advisory Log
 acknowledging alarms *12-13*
 clearing alarms *12-14*
 expanded advisory information *12-14*
 resetting alarms *12-14*

Advisory Message *12-13*

AHU Zone Control *11-24*

AHUs *11-21*
 curtailment *11-23*
 dehumidification *11-23*
 fan control during *11-22*
 economizers *11-22*
 analog *11-23*
 digital *11-23*
 enabling *11-22*
 lockout features *11-23*
 fan control *11-21*
 during dehumidification *11-22*
 single-speed fans *11-21*
 two-speed fans *11-22*
 variable-speed fans *11-22*
 optimum start-stop (OSS) *11-23*
 overview *11-21*
 temperature control *11-21*
 alternate set points *11-21*

Alarm Advisory Log
 accessing *12-12*
 viewing *12-12*

Alarm Advisory Messages *C-1*

Alarm Annunciator Setup *10-22*

Alarm Reporting *10-23*

Alarms *12-12*
 acknowledging *12-13*
 advisory log
 accessing *12-12*
 viewing *12-12*

- date and time stamp *12-12*
- dial-out *10-21*
 - The Alarm Output *10-21*
 - The Display Line *10-21*
 - The Echelon Network *10-21*
- forced to normal. See Alarms, reset to normal.
- resetting *12-14*
- reset-to-normal *12-13*
- return-to-normal *12-13*
- state, in advisory log *12-12*
- the Alarm Annunciator *10-21*
- Alternate I/O Formats *10-26*
- Analog Sensor Control *11-38*
- Anti-Sweat
 - case-controlled *11-13*
 - dewpoint input *11-14*
 - how setpoints work *11-14*
 - how anti-sweat works *11-45*
 - setup *11-45*
 - zones, definition of *11-45*
- Application Setup *10-25*
- B-**
- Base Log Group *11-17*
- Baud Rates *10-12*
 - E2
 - RS-232 port *10-12*
 - E2, setting for I/O Network *10-12*
 - I/O Network *6-3*
 - 8DO *6-4*
 - 8IO *6-4*
 - ARTC *6-4*
 - E2 *6-3*
 - IRLDS *6-3*
- Blue "R". See *Cold Reset*.
- Board Types *6-1*
- Boards on the I/O Network *10-2, 10-15*
- Boiler *11-55*
- Box to Box Communications *7-1*
- Box-To-Box *1-5*
- Building Controller *1-2*
- Buttons
 - cold reset *10-1*
 - reset *10-1*
- BX Capabilities *1-2*
- BX Home Screen *12-1*
- C-**
- Case Circuits, Standard. See *Standard Circuits*.
- Case Control Circuits
 - associating CC-100s with *11-16*
 - defrost in *11-12*
 - overview *11-10*
- Case Controllers
 - anti-sweat control *11-13*
 - associating with Case Control Circuits *11-16*
 - CC-100H
 - defined *2-11, 11-10*
 - CC-100LS
 - defined *2-11, 11-10*
 - CC-100P
 - defined *2-11, 11-10*
 - CCB *9-18*
 - clean mode *11-14*
 - CS-100
 - defined *2-11, 11-10*
 - defrost *11-12*
 - pump down delay *11-12*
 - defrost types *11-12*
 - digital sensors
 - installing *9-16*
 - dual temp control *11-14*
 - EEPRs
 - recovery mode *11-12*
 - fail-safe mode *11-15*
 - fan control *11-14*
 - humidity sensor installation *9-16*
 - inputs *9-16*
 - installation guide *8-6*
 - light control *11-14*
 - mounting dimensions *3-5*
 - power modules
 - wiring *9-17*
 - wiring schematic *9-17*
 - problems with cases *F-6*
 - recovery mode
 - EEPRs *11-12*
 - EEVs *11-11*
 - sensor default locations *9-16*
 - sensor failures *11-15–11-16*
 - sensors
 - default installation locations *9-16*
 - setting up individual CC-100s *11-16*

- specifying the number of 10-2, 10-16
- stand-alone mode 11-15
- superheat control 11-11
- temperature control 11-11
- temperature probes
 - installing 9-16
- valve cable 9-17
- valves 11-11
 - EEPRs 11-12
 - EEVs 11-11
 - liquid pulse 11-11
 - liquid stepper 11-11
 - pulse 11-11
 - stepper 11-11
 - suction stepper 11-12
- walk-in freezer control 11-15
- wash mode. *See Clean Mode.* 11-14
- CC-100H. *See Case Controllers.*
- CC-100LS. *See Case Controllers.*
- CC-100P. *See Case Controllers.*
- CCB Case Controllers 9-18
- Checking Boards Online 10-15, 12-11
- Checking Status Screens 12-11
- Clean Mode 11-14, 12-9
 - initiating 12-9
- Clean Out 10-1
- Clean Switches 11-7
- Cold Reset
 - performing a 10-1
- Cold Reset Button 10-1
- COM Port Setup 5-1
- Commissioning 10-16
- Commissioning CC-100s 10-16
 - how commissioning works 10-17
- Commissioning MODBUS 10-17
- Compressors
 - troubleshooting F-3
- Condensers
 - air cooled 11-3
 - strategy 11-3
 - bypassing fan stages 12-10
 - evaporative 11-4
 - fail-safe dip switch setup 11-5
 - fan control 11-4
 - single-speed 11-4
 - two-speed 11-4
 - variable-speed 11-4
 - fast recovery 11-4
 - hardware overview 11-4
 - input types 11-5
 - output wiring 11-5
 - overriding compressor stages 12-10
 - problems with F-5
 - split mode 11-4
 - Temperature Differential Strategy 11-3
- Control Keys 12-8
- Control Techniques VSD 6-6
- Convenience Store Controller 1-3
- Cool cut in/cut out setpoints 11-52
- Copeland Digital Discus Compressor 11-1, 11-2
- Copeland ISD Compressors 6-6
- CPU 2-2
- Creating 10-14
- CS-100 11-10
- CS-100. *See Case Controllers, CS-100*
- CT Drives 6-6
- CUB 2-6, 11-30
- CX Home Screen 12-2
- D-**
- Daisy Chains
 - diagram of 6-2
- Date and Time 12-12
- Date Setup 10-9
- Daylight Savings Dates 10-10
- Defrost
 - defrost cycle 11-6, 11-12
 - demand 11-13
 - fail-safe time 11-13
 - drip time. *See Defrost, run-off time.*
 - electric 11-13
 - emergency 11-13
 - initiating 12-9
 - hot gas 11-12
 - in case controlled circuits 11-12
 - inhibiting, using demand sensors 11-13
 - manual defrost
 - ending a cycle 12-10
 - initiating 12-9
 - off-cycle 11-12
 - pulsed 11-13
 - pump down delay 11-12
 - reverse cycle hot gas 11-12

- run-off time *11-12*
- standard circuits *11-6*
 - defrost states *11-6*
 - defrost type *11-6*
 - electric defrost *11-6*
 - emergency defrost *11-7*
 - pulsed defrost *11-7*
 - termination *11-7*
 - timed and reverse air *11-6*
- termination *11-13*
 - pulsed defrost *11-13*
 - temperature *11-13*
 - timed (off-cycle) *11-12*
- Dehumidification *11-52*
- Demand
 - explanation of *11-43*
- Demand Control *11-34*
- Demand Defrost. *See Defrost, demand.*
- Detailed Setpoint Change Logging *11-56*
 - Log Information *11-56*
 - Logged Changes *11-57*
 - Unlogged Changes *11-57*
- Dewpoint Probe *3-10*
 - location *3-10*
 - mounting *3-10*
- Dewpoint Probe. *See Sensors, dewpoint probe.*
- DHCP Enabled *10-11*
- Digital Discus Compressor *11-1, 11-2*
- Digital Scroll Compressor Support *11-2*
- Digital Sensor Control *11-38*
- Dip Switches
 - baud rate *6-3*
 - input type *9-1*
 - network settings *6-3*
- Discontinued boards
 - 16Aie *2-10*
 - 8ROe *2-10*
- Discus *6-8*
- Discus Compressor *11-1, 11-2*
- Door Switches *11-7*
- E-**
- E2 *1-1*
 - blank face *3-3*
 - Box-to-Box *1-5*
 - capabilities *1-1*
 - connection to other *1-5*
 - documentation *1-6*
 - Echelon connectors *4-2*
 - Echelon jumpers *4-2*
 - installation instructions *4-4*
 - mounting
 - blank face *3-3*
 - recessed mount *3-1*
 - retrofit *3-2*
 - standard mount *3-1*
 - networking
 - introduction to *1-4*
 - Quick Start *10-1*
 - repeater
 - part number for manual *1-6*
 - routers
 - part number for manual *1-6*
 - RS-232 Baud Rate *10-12*
 - RS485 port *4-2*
 - RS485 termination jumpers *4-2*
 - specifications *2-2*
 - user's guide *1-6*
- EC-2 Case Controller
 - defined *2-11*
 - detail *2-11*
- Echelon Network
 - checking boards online *10-15, 12-11*
 - daisy-chaining *8-1*
 - device wiring *8-1*
 - E2 RX *1-5*
 - installing Echelon devices *8-3*
 - location of connectors on E2 *4-2*
 - maximum number of nodes *8-2*
 - Neuron ID number
 - manual entry of *10-18*
 - overview *8-1*
 - peripherals for the *1-5*
 - powering Echelon devices *8-3*
 - problems with *F-2*
 - subnets
 - setting the number *10-2, 10-16*
 - termination block installation *8-3*
 - unit controllers *10-2, 10-16*
 - wire length limitations *8-3*
 - wire restrictions *8-3*
 - wiring *8-1*
 - wiring type *8-1*

- Echelon Network, Setting Up 10-16
- Economizers. *See AHUs, economizers.*
- ECT MODBUS
- Energy Meter 6-7
 - iPro DAC 6-7
 - MRLDS 6-7
 - XR, XEV and XEV22D Case Controller 6-6
- Edit Menu 10-26
- EEPRs. *See Valves.*
- EEVs. *See Valves.*
- Electric Defrost. *See Defrost, electric.*
- Enhanced Lighting
- combination strategies 11-31
 - occupied mode 11-32
- Enhanced Suction Group 11-1
- ESR8 Board
- installation guide 8-7
 - specifying the number of 10-2, 10-16
- Ethernet Box to Box 7-1
- F-**
- Flexible Combiner 1-6, 11-53
- Full Options On and Off 12-2
- Function Buttons
- BX controller 12-11
 - RX controller 12-11
- Function Keys 10-4, 10-27
- G-**
- Gateway Board 2-3
- models 2-4
- Global Data
- priority settings 10-24
 - setup 10-23
- Graph View 12-17
- zooming 12-17
- H-**
- Hand-held Terminal 2-7
- connection to case controller 9-16
- Hardware Overview 2-1
- Header Icons 10-4, 12-6
- Heat cut in/cut out setpoints 11-52
- Help Line 10-27
- Holiday Schedules 11-43
- Home Screens
- RX and BX 12-1
- Hot Gas Defrost. *See Defrost, hot gas.*
- Hot Keys 12-8
- Humidistats. *See Sensors, humidity.*
- Humidity Sensors. *See Sensors, humidity.*
- I**
- I/O Board Names 6-1
- I/O Boards
- snap-track installation 3-4
- I/O Formats
- alternate 10-26
- I/O Network
- baud rate 10-12
 - Baud Rate Dip Switches 6-3
 - Baud Rate Settings
 - ARTC 6-4
 - baud rate settings 6-3
 - 8DO 6-4
 - 8IO 6-4
 - E2 6-3
 - IRLDS 6-3 - boards on the 10-2, 10-15
 - checking boards online 10-15, 12-11
 - daisy chains 6-2
 - dip switches and rotary dials 6-3
 - E2 RX 1-4
 - max number of RS485 Boards 6-1
 - peripherals for the 1-4
 - problems with F-1
 - terminating resistance jumpers 6-4
- I/O Network, Setting Up 10-15
- Icons 10-4
- IMC Controllers 6-6
- Index Tabs 10-26, 12-6
- Inputs
- analog
 - default values on sensor failure 9-9
 - selecting units 9-9
 - setup screen 9-7 - digital
 - push button mode 9-10
 - selecting units 9-9 - pulse type
 - setting units per pulse 9-9
- Insertion Temperature Probe. *See Sensors, Insertion Probe.*
- Inside Temperature Sensor. *See Sensors, Inside Temperature.*
- Installation Guide

- 16AI 6-14
- 4AO 6-11
- 8IO 6-13
- CC-100/CS-100 8-6
- E2 4-4
- ESR8 8-7
- MultiFlex 16 6-9
- MultiFlex Combo 6-10
- MultiFlex ESR 6-15, 6-16, 6-17
- TD3 8-8
- Internal Modems (New Processor Board) 3-5, 4-3
- IRLDS
 - specifying the number of 10-2, 10-15
- Irrigation
 - zones and cycles
 - cycle control types 11-51
 - cycle control types
 - timed 11-51
 - volume 11-51
 - cycle scheduling 11-51
 - flow sensor related tests 11-52
 - leak 11-52
 - obstructed zone 11-52
 - number of zones 11-50
 - override failsafe 11-52
 - service modes 11-52
 - zone inhibit 11-51
 - alarm 11-51
 - freeze lockout 11-51
 - rain delay 11-51
 - timed 11-51
 - volume 11-51
 - zone override 11-51
 - zones and cycles 11-50
- J-**
- Jumpers
 - Echelon termination
 - E2 4-2
 - RS485 termination
 - E2 4-2
 - termination
 - settings on I/O boards 6-4
- K-**
- Keyboard 2-2
- Keypad 12-6
- KW Transducer 9-6
- KW Transducer. *See also Sensors, KW Transducer.*
- L-**
- LED Status
 - Keyboard 2-3
 - Main Board (CPU) 2-3
 - PIB 2-2
- LEDs Plug-In I/O Card 4-3
- License Management 10-19
- Licensing 1-7
- Light Level Sensor 3-10
- Lighting
 - alternate control 11-32
 - multi-logic combiner 11-32
 - offset solar 11-33
 - control method select 11-31
 - functions 11-31
 - overview 11-30
 - separate control
 - min ON/OFF cell 11-33
 - proof cell 11-33
 - slave scheduling 11-33
 - standard control 11-31
 - light level interface 11-31
 - schedule interface cell 11-32
 - unoccupied mode 11-32
- Line Up ESR 11-6
- Line Up MultiFlex ESR 11-6
- Liquid Level Sensors 3-11
- Log View 12-16
- Logged Inputs and Outputs 12-15
- Logging
 - power monitoring 11-44
- Logging Groups 11-16
 - Base Log Group 11-17
 - Data Compression 11-17
 - Clipping 11-17
 - Incompressible DataTypes 11-17
 - Log Reports 11-19
 - Logging Setup 11-18
- Logging On 10-1
- Logs and Graphs 12-15
- LonMark Device 8-5
- LonWorks Network. *See Echelon Network.*

-M-

Main Board 2-2
Main Processor Board 2-2
Main Status Screen 10-3
Manual Defrost
 ending 12-10
 initiating from Main Status Screen 12-9
Memory
 clearing all data from 10-1
Menu
 actions 10-6
 User Access 10-13
Menus 12-3
Messages
 alarm advisory C-1
MODBUS Commissioning 10-18
Modem
 setup 10-10
Modem Board 3-5, 4-3
 External Modem 4-3
 Internal Modem 4-3
Modem Mounting 3-6
Modem/Communication Expansion Board 3-5
Modem/Communication Expansion Card 4-3
Modular Chiller Control 11-53
Mounting
 bullet and pipe mount sensors 3-8
 CC-100 3-5
 dewpoint probe 3-10
 E2
 blank face 3-3
 recessed mount 3-1
 retrofit 3-2
 standard mount 3-1
 I/O Boards And Enclosures
 single enclosure 3-3
 light level sensors 3-10
 liquid level sensors 3-11
 temperature sensors
 insertion probe 3-8
 inside 3-7
 outside 3-7
 supply and return air sensors 3-8
MRLDS 6-7
MultiFlex Boards
 1616 6-5

MultiFlex
 mounting in enclosure 3-3
 plus board 6-2
MultiFlex 16 Board
 features 2-4
MultiFlex Boards 2-4
 16 2-4
 combination input/output 2-5
 CUB 2-6, 11-30
 PAK 2-6, 11-30
 RCB 2-6, 11-26
 RCB,RTU compared 11-26
 RTU 2-6
MultiFlex CUB 2-6, 11-30
MultiFlex ESR Board 2-7
MultiFlex I/O Board
 Relay Output Test Mode 9-11
MultiFlex PAK 2-6, 11-30
MultiFlex Plus Board 6-2
MultiFlex RCB 2-6, 11-26
MultiFlex RTU 2-6, 11-26
-N-
Navigation 12-3
Network
 RS485 I/O
 baud rate dip switches 6-3
 daisy chain diagram 6-2
 dip switches and rotary dials for board numbering 6-3
Network Summary Screen 12-11
Neuron ID
 manual entry of 10-18
No Description File 8-5
Noise Minimization 6-2
-O-
Off-Cycle Defrost. *See Defrost, off-cycle.*
Open Echelon 8-4
Operator's Guide to Using the E2 12-1
OSS. *See AHUs, optimum start-stop.*
Outputs
 digital
 selecting units 9-14
Outside Temperature Sensor. *See Sensors, outside temperature.*
Overrides
 initiating 12-10

-P-

PAK 2-6, 11-30

Part Numbers and Model Descriptions 2-1

Passwords

setting 10-13

Peer Communications 7-1

closed network layout 7-2

ethernet IP configurations 7-1

ethernet network layouts 7-2

hardware specifications 7-1

open network layout 7-2, 7-3

software specifications 7-2

troubleshooting 7-4

PIB 2-2

PID Control D-1

Plus Board 6-2

PMAC II

defined 2-9

Pointers

input and output 12-16

Points. *See Inputs or Outputs.*

Power

I/O Boards 6-5

Power Modules

wiring 9-17

wiring schematic 9-17

Power Monitoring 11-43

daily logs 11-44

hourly logs 11-44

logging 11-44

monthly logs 11-44

shed mode 11-43

Pressure Transducers 3-7

Pulse Accumulation 11-49

accumulator reset types 11-50

configuration 11-49

high trip 11-50

logging 11-50

outputs 11-49

Pulse Modulating Anti-Sweat Controller. *See PMAC II.*Pulsed Defrost. *See Defrost, pulsed.***-R-**

RCB 2-6, 11-26

Recovery Mode, for Case Controllers 11-11

Refrigeration Controller 1-1

Relay Output Test Mode 9-11

Repeaters

part number for manual 1-6

two-channel

mounting 3-6

Reset Button 10-1

Resetting 12-14

Resetting the E2 Controller 10-1

Retrofit Mounting 3-2

Returned-To-Normal and Forced-To-Normal Alarms 12-12

Reverse Cycle Hot Gas. *See Defrost, reverse cycle hot gas.*

RMS 11-56

RMS Asset 11-56

RMS Scale 11-56

Rotary Dials

I/O Board Settings 6-3

Settings For 8IO 6-3

Routers

part number for manual 1-6

RS-232 Baud Rate 10-12

RS485 Network

I/O Network 6-1

noise minimization 6-2

RTU 2-6, 11-26

RX Capabilities 1-1

RX Home Screen 12-1

-S-

Screen Elements 10-4

function keys 10-4

header 10-4

Help line 10-4

Screen Types 10-5, 12-5

actions menu 10-6

RX and BX Main Menus 10-5

setup screens 10-7

status screens 10-5

system configuration menu 10-7

system information menu 10-8

Screens

Main Status 10-3

Status 10-5

Sensor Control

analog

alarm control 11-38

- combiner function *11-38*
- cut in/cut out control *11-38*
- analog sensor control modules *11-38*
- digital
 - alarm control *11-39*
 - logical combination methods *11-39*
- digital sensor control modules *11-38*
- Sensors
 - analog
 - E2 setup *9-7*
 - analog liquid level indicator
 - wiring to input board *9-5*
 - bullet and pipe mount
 - mounting *3-8*
 - coil in temperature
 - location *3-8*
 - mounting *3-8*
 - coil out temperature
 - location *3-8*
 - mounting *3-8*
 - dewpoint (wall-mounted) *9-4*
 - dewpoint probe *3-10*
 - location *3-10*
 - mounting *3-10*
 - wiring to input board *9-5*
 - digital
 - selecting units *9-9*
 - wiring to input board *9-3*
 - Hansen probe. *See Sensors, liquid level probe.*
 - humidity
 - connecting to a case controller *9-16*
 - installation *3-8*
 - indoor RH sensors *3-9*
 - outdoor RH sensor *3-9*
 - insertion probe *3-8*
 - location *3-8*
 - mounting *3-8*
 - inside temperature *3-7*
 - location *3-7*
 - mounting *3-7*
 - Klixons
 - wiring to input board *9-3*
 - KW Transducer
 - wiring to input board *9-6*
 - light level
 - location *3-10*
 - mounting *3-10*
 - wiring to input board *9-4*
 - liquid level
 - mounting *3-11*
 - liquid level probe
 - wiring to input board *9-5*
 - offsets *9-9*
 - outside temperature *3-7*
 - location *3-7*
 - mounting *3-7*
 - power connections on input boards for *9-2*
 - pressure transducers
 - Eclipse
 - wiring to input board *9-3*
 - Eclipse voltage-to-pressure chart *B-1*
 - mounting *3-7*
 - refrigeration probes and sensors *3-8*
 - location *3-8*
 - mounting *3-8*
 - relative humidity
 - (wall-mounted) *9-4*
 - wiring to input board *9-3*
 - sail switches
 - wiring to input board *9-3*
 - supply and return air
 - mounting *3-8*
 - temperature
 - temp-to-resistance chart *B-1*
 - wiring to input board *9-3*
 - Wiring To 16AI/8IO Input Points *9-1*
- Separate Setpoints *11-24*
 - configuration *11-53*
- Serial Configuration *5-1*
- Serial Connection Manager *5-1*
- Serial Tab *5-1*
- Service Button *10-17*
 - CC-100 *10-18*
- Setpoints
 - separate *11-24*
- Setpoints, entering *10-26*
- Setting Number of Applications *10-3*
- Setting the Time and Date *10-9*
- Setup Screen *12-5*
- Setup Screen Configuration *10-25*
- Setup Screens *10-7*

- Single Enclosure Mounting For I/O Boards 3-3
- Snap-track Installation For I/O Boards 3-4
- SNTP Support 10-9
- Software Applications 11-1
- Software Licensing 1-7, 10-19
- Software Overview
 - Demand Control
 - Demand Monitoring 11-34
- Specify Number of Boards 10-15
- Split Mode 11-4
- Standard Circuits
 - defrost 11-6
 - electric defrost 11-6
 - hot gas 11-6
 - reversed cycle hot gas 11-6
 - states 11-6
 - termination 11-7
 - timed and reverse air 11-6
 - types 11-6
 - emergency defrost 11-7
 - fan control 11-8
 - inputs
 - wiring 11-9
 - line up ESR Defrost control 11-6
 - line up MFESR Defrost control 11-6
 - outputs
 - wiring 11-10
 - problems with F-6
 - pulsed defrost 11-7
 - refrigeration control 11-5
 - line up ESR 11-6
 - line up MFESR 11-6
 - temperature control 11-6
 - temperature monitor 11-6
 - temperature control 11-6
 - temperature monitor 11-6
 - wiring 11-8
- State 12-12
- Status Screen 12-5
- Status Screen, The Main 10-3
- Status Screens 10-5
 - Circuit Status Screens 12-11
 - Condenser Status Screen 12-11
 - Home Screen 12-1
 - navigation of cursor 12-6
 - Network Summary Screen 10-15, 12-11
- Sensor Control Screen 12-11
- Suction Group Status Screen 12-11
- Subnet
 - setting the number 10-2, 10-16
- Suction Groups 11-1
 - bypassing compressor stages 12-10
 - Enhanced 11-1
 - floating setpoint control 11-1
 - hardware overview 11-2
 - Introduction 11-1
 - overriding compressor stages 12-10
 - PID control strategy overview 11-1
 - variable-speed compressors 11-1
- Summary Screen 12-5
- Superheat Control 11-11
- Supply And Return Air Sensors 3-8
- System Configuration Menu 10-7
- System Information Menu 10-8
- T-**
- Tabs, Index 10-26
- TCP/IP
 - setup 10-11
- TD3 Temperature Display
 - defined 2-11
 - features 2-11
- Temperature Control
 - case controllers 11-11
- Temperature Differential (TD) Control 11-48
 - alarms 11-49
 - configuration 11-48
 - inputs 11-49
 - setpoints 11-48
 - TD failsafes 11-48
 - TD strategy 11-48
- Temperature Differential Strategy 11-3
- Termination 8-2
 - block 8-3
 - Echelon jumpers
 - E2 4-2
 - RS485 jumpers
 - E2 4-2
- Termination Block 8-3
- Termination Resistance Jumpers I/O Network 6-4
- Termination Resistance Jumpers, I/O Network. *See Jumpers, termination.*

Thermostatic Expansion Valves. *See TXVs.*

Time/Date Setup 10-9

Active Date 10-9

Active Time 10-9

Date Format 10-10

Daylight Savings Dates 10-10

Daylight Savings Time uses GMT 10-10

Sundown 10-10

Time Zone 10-9

Unit Location From 10-10

Toggle Full Options 12-2

Transducers, Pressure. *See Sensors, pressure transducers.*

Transformers

I/O board 6-5

selecting the correct VA rating 6-5, 8-3

six-board 6-5

ten-board 6-5

three-board 6-5

Troubleshooting *F-1*

Two speed fan control 11-52

TXVs

control using CC-100s 11-12

-U-

Unit Controllers (Echelon) 10-2, 10-16

User Access Menu 10-13

Username, Creating 10-13

-V-

Valves

EEPR

cables for CC-100 9-17

EEVs

cables for CC-100 9-17

Emerson Flow Controls ESR

wire colors 9-18

Emerson Flow Controls ESV

wire colors 9-18

Sporlan CDS

wire colors 9-18

Sporlan SEI

wire colors 9-18

-W-

Watt-hour Transducer. *See Sensors, KW Transducer.*

Web Services 10-20

Wire Types, Echelon Network 8-1

-Z-

Zone Control 11-25

AHUs 11-24, 11-26

dehumidification 11-28

dehumidification 11-28

economization 11-27, 11-28

enabling 11-27

MultiFlex RTU 11-26

MultiFlex RTUs

dehumidification 11-28

optimum start-stop (OSS) 11-28

stand-alone mode 11-29

MultiFlex RTU 11-29

temperature control 11-26

zone humidity 11-28

zone temperature 11-27

